



analog FOUR

4 Voice Analog Synthesizer

FULL REFERENCE MANUAL

FCC compliance statement

This device complies with part 15 of the FCC rules. Operation is subject to the following two conditions: (1) This device may not cause harmful interference, and (2) this device must accept any interference received, including interference that may cause undesired operation.

NOTE: This equipment has been tested and found to comply with the limits for a Class B digital device, pursuant to Part 15 of the FCC Rules. These limits are designed to provide reasonable protection against harmful interference in a residential installation. This equipment generates, uses and can radiate radio frequency energy and, if not installed and used in accordance with the instructions, may cause harmful interference to radio communications. However, there is no guarantee that interference will not occur in a particular installation. If this equipment does cause harmful interference to radio or television reception, which can be determined by turning the equipment off and on, the user is encouraged to try to correct the interference by one or more of the following measures:

- Reorient or relocate the receiving antenna.
- Increase the separation between the equipment and receiver.
- Connect the equipment into an outlet on a circuit different from that to which the receiver is connected.
- Consult the dealer or an experienced radio/TV technician for help.

 **WARNING:** Cancer and Reproductive Harm – www.P65Warnings.ca.gov

Canada

This Class B digital apparatus complies with Canadian ICES-003.
Cet appareil numérique de la classe B est conforme à la norme NMB-003.

European Union regulation compliance statement

This product has been tested to comply with the Low Voltage Directive 2006/95/EC and the Electromagnetic Compatibility Directive 2004/108/EC. The product meets the requirements of RoHS 2 Directive 2011/65/EU.



This symbol indicates that your product must be disposed of properly according to local laws and regulations.

The included switched-mode power supply is CEC Level V compliant.

Legal disclaimer

The information in this document is subject to change without notice and should not be construed as a commitment by Elektron. Elektron assumes no responsibility for any errors that may appear in this document. Elektron may also make improvements and/or changes in the products and programs described in this document at any time without notice. In no event shall Elektron be liable for any special, indirect, or consequential damages or any damages whatsoever resulting from loss of use, data, or profits, whether in an action of contract, negligence, or other action, arising out of or in connection with the use or performance of this information.

IMPORTANT SAFETY AND MAINTENANCE INSTRUCTIONS

Please read these instructions carefully and adhere to the operating advice.

1. Do not use this unit near water.
2. Never use aggressive cleaners on the casing or on the screen. Remove dust, dirt and fingerprints with a soft, dry and non-abrasive cloth. More persistent dirt can be removed with a slightly damp cloth using only water. Disconnect all cables while doing this. Only reconnect them when the product is safely dry.
3. To avoid scratches or damage, never use sharp objects near the casing or the LCD screen. Avoid applying any pressure to the screen itself.
4. Install in accordance with the manufacturer's instructions. Make sure you place the unit on a stable surface before use. If you mount the unit in a rack, be sure to tighten all four screws in the rack mount holes.
5. Connect the unit to an easily accessible electrical outlet close to the unit.
6. When transporting the unit, use accessories recommended by the manufacturer or the original box and padding.
7. Do not install near any heat sources such as radiators, heat registers, stoves, or any other equipment (including amplifiers) producing heat.
8. Do not put the PL-2 Protective Cover (Elektron accessory) on the unit while the unit is powered on.
9. Do not block the ventilation holes located on the side and the bottom of the enclosure of the unit. Attaching rack ears is still possible because of increased general ventilation when the unit is rack mounted. Also, make sure there is sufficient air circulation in the room where the unit is kept.
10. This product, by itself or in combination with amplifiers, headphones or speakers, is capable of producing sound levels that may cause permanent hearing loss. Do not operate at a high volume level or at a level that is uncomfortable.
11. Protect the power cord from being walked on or pinched particularly at plugs, convenience receptacles, and the point where they exit from the unit.
12. Use attachments/accessories specified by the manufacturer.
13. Unplug this unit during lightning storms or when it is not used for long periods of time.
14. Refer all servicing to qualified service technicians. Servicing is required when the unit has been damaged in any way, liquid has been spilled or objects have fallen into the unit, the unit has been exposed to rain or moisture, does not operate normally, or has been dropped.

WARNING

To reduce the risk of fire, electrical shock or product damage:

- Do not expose the unit to rain, moisture, dripping or splashing and also avoid placing objects filled with liquid, such as vases, on the unit.
- Do not expose the unit to direct sunlight, nor use it in ambient temperatures exceeding 35°C as this can lead to malfunction.
- Do not open the casing. There are no user repairable or adjustable parts inside. Leave service and repairs to trained service technicians only.
- Do not exceed the limitations specified in the Electrical specifications.

SAFETY INSTRUCTIONS FOR THE POWER ADAPTER

- The adapter is not safety grounded and may only be used indoors.
- To ensure good ventilation for the adapter, do not place it in tight spaces. To prevent risk of electric shock and fire because of overheating, ensure that curtains and other objects do not prevent adapter ventilation.
- Do not expose the power adapter to direct sunlight, nor use it in ambient temperatures exceeding 40°C.
- Connect the adapter to an easily accessible electrical outlet close to the unit.
- The adapter is in standby mode when the power cord is connected. The primary circuit is always active when the cord is connected to the power outlet. Pull out the cord to completely disconnect the adapter.
- In the EU, only use CE approved power cords.

TABLE OF CONTENTS

1. INTRODUCTION	10
1.1 CONVENTIONS IN THIS MANUAL	10
2. ANALOG FOUR BACKGROUND	11
3. PANEL LAYOUT AND CONNECTORS	12
3.1 FRONT PANEL	12
3.2 REAR CONNECTORS	13
3.3 ANALOG FOUR ACCESSORIES	14
3.3.1 RACK MOUNT KIT	14
3.3.2 ECC-2 CARRYING BAG & PL-2 PROTECTIVE LID	14
3.4 CONNECTING THE UNIT	14
4. ANALOG FOUR SIGNAL PATH	15
4.1 ABOUT THE COMPONENTS	15
4.1.1 COMMENTS ON THE SIGNAL PATH	15
4.1.2 ABOUT THE OSCILLATORS AND FILTERS	15
5. OVERVIEW OF THE ANALOG FOUR STRUCTURE	16
5.1 +DRIVE	16
5.2 DATA STRUCTURE	16
5.2.1 PROJECT	16
5.2.2 KIT	16
5.2.3 SOUND	16
5.2.4 BANK	16
5.2.5 PATTERN	16
5.2.6 SONG	16
5.2.7 CHAINS	17
5.2.8 GLOBAL	17
5.3 ABOUT THE TRACK TYPES	17
5.3.1 THE SYNTH TRACKS	17
5.3.2 THE FX TRACK	17
5.3.3 THE CV TRACK	17
5.3.4 EDITING THE TRACKS	17
6. INTERACTING WITH THE ANALOG FOUR	18
6.1 PARAMETER EDITING	18
6.1.1 QUICK PARAMETER EDITING	18
6.1.2 PARAMETER VALUE JUMP	18
6.2 [FUNCTION] KEY PRESS COMBINATIONS	18
6.3 QUICK SCROLLING	18
6.4 COPY, CLEAR AND PASTE	19
6.5 THE NAMING MENU	19
6.5.1 POP-UP MENU NAMING	19
6.6 OVERBRIDGE	19
6.7 BACKING UP THE ANALOG FOUR	20
6.8.1 BACKING UP PROJECTS AND SOUNDS	20
6.8.2 TRANSFERRING BACKED UP FILES TO YOUR ELEKTRON DEVICE	20
7. QUICK START	22
7.1 PLAYING THE FACTORY PRESETS	22
7.1.1 PERFORMANCE MODE	22
7.1.2 ADJUSTING PARAMETERS	22

8. PROJECTS	23
8.1 PROJECT MENU	23
8.1.1 LOAD PROJECT	23
8.1.2 SAVE PROJECT	23
8.1.3 PROJECT MANAGER	24
9. KITS AND SOUNDS	25
9.1 THE +DRIVE SOUND LIBRARY AND THE SOUND POOL	25
9.2 KIT MENU	25
9.2.1 RELOAD KIT	25
9.2.2 LOAD KIT	25
9.2.3 SAVE KIT	26
9.2.4 CLEAR KIT	26
9.2.5 PERFORMANCE	26
9.2.6 POLY CONFIG.	26
9.2.7 VOICE ROUTING	26
9.3 PERFORMANCE MODE	26
9.3.1 PERFORMANCE SETUP	27
9.3.2 PERFORMANCE CONFIGURE	27
9.3.3 PERFORMANCE RENAME	27
9.3.4 PERFORMANCE MUTE	28
9.3.5 PERFORMANCE MIXER	28
9.4 POLYPHONY	28
9.4.1 POLYPHONY CONFIGURATION	28
9.4.2 VOICE ROUTING	29
9.5 SOUND MENU	32
9.6 SOUND BROWSER	32
9.6.1 VIEW POOL	32
9.6.2 VIEW +DRIVE	32
9.6.3 SORT ABC	32
9.6.4 SORT 123	32
9.6.5 FILTER	32
9.6.6 SEARCH	32
9.7 SOUND MANAGER	33
9.7.1 LOAD TO TRACK	33
9.7.2 COPY TO	33
9.7.3 STORE TRACK SOUND	33
9.7.4 RENAME	33
9.7.5 EDIT TAGS	33
9.7.6 DELETE	33
9.7.7 TOGGLE	34
9.7.8 SEND SYSEX	34
9.7.9 SELECT ALL	34
9.7.10 SELECT UNUSE	34
9.7.11 DESELECT ALL	34
9.8 CLEAR TRACK SOUND	34
9.9 RENAME TRACK SOUND	34
9.10 SETTINGS	34
9.10.1 OSCILLATOR DRIFT	34
9.10.2 F1 RESONANCE BOOST	34
9.10.3 VELOCITY TO VOL	35
9.10.4 LEGATO MODE	35
9.10.5 PORTAMENTO	35

9.10.6 VELOCITY MOD	35
9.10.7 PITCH BEND	35
9.10.8 MODULATION WHEEL	35
9.10.9 BREATH CONTROLLER	35
9.10.10 AFTERTOUCHE	35
9.11 PLAYING A SOUND	35
9.11.1 PLAYING A SOUND WITH A MIDI KEYBOARD	36
9.12 EDITING A SOUND	36
9.13 EDITING THE FX AND CV TRACKS	36
9.13.1 THE FX TRACK	36
9.13.2 THE CV TRACK	37
9.14 TRACK MUTING	37
10. THE SEQUENCER	38
10.1 BASIC PATTERN OPERATIONS	38
10.1.1 SELECTING A PATTERN	38
10.1.2 PATTERN CONTROL	38
10.1.3 TEMPO	39
10.2 PATTERN MODES	39
10.3 EDITING A PATTERN	39
10.3.1 TRIG TYPES	39
10.3.2 GRID RECORDING MODE	40
10.3.3 LIVE RECORDING MODE	40
10.3.4 STEP RECORDING MODE	40
10.4 TRACK MENU	41
10.4.1 NOTES SETUP	41
10.4.2 ARP SETUP	41
10.4.3 RELOAD TRACK	41
10.4.4 SAVE TRACK	42
10.5 PATTERN MENU	42
10.5.1 RELOAD PATTERN	42
10.5.2 SAVE PATTERN	42
10.6 ARPEGGIATOR	42
10.6.1 MOD	42
10.6.2 SPD	43
10.6.3 RNG	43
10.6.4 LEG	43
10.6.5 LEN	43
10.6.6 NO2-NO4	43
10.7 ARPEGGIATOR SETUP	43
10.8 NOTE MENU	44
10.8.1 NOT	44
10.8.2 VEL	44
10.8.3 LEN	44
10.8.4 μTM	44
10.8.5 PRB	44
10.8.6 ENV (F)	44
10.8.7 ENV (2)	44
10.8.8 LFO (1)	44
10.8.9 LFO (2)	44
10.9 NOTES SETUP	45
10.9.1 GLOBAL QUANTIZE	45
10.9.2 TRK QUANTIZE	45

10.9.3 TRK KEY SCALE	45
10.9.4 TRK KEY NOTE	45
10.9.5 TRK TRANSPOSABLE	45
10.9.6 SEND MIDI	45
10.10 CLICK TRACK	45
10.10.1 ACTIVE	46
10.10.2 TIME SIG. NUM	46
10.10.3 TIME SIG. DEN	46
10.10.4 PREROLL	46
10.10.5 VOLUME	46
10.11 SCALE MENU	46
10.11.1 NORMAL MODE	46
10.11.2 ADVANCED MODE	46
10.12 SEQUENCER FEATURES	47
10.12.1 PARAMETER LOCKS	47
10.12.2 SOUND LOCKS	48
10.12.3 CONDITIONAL LOCKS	48
10.12.4 TRIG MUTE	49
10.12.5 ACCENT	49
10.12.6 NOTE SLIDE	49
10.12.7 PARAMETER SLIDE	50
10.12.8 SWING	50
10.12.9 TRACK TRANSPOSE	50
10.12.10 DESTRUCTIVE TRANSPOSE	51
10.12.11 COPY, PASTE, AND CLEAR OPERATIONS	51
10.12.12 QUICK SAVE AND RELOAD COMMANDS	51
11. CHAINS AND SONGS	53
11.1 CHAINS	53
11.1.1 DETAILED MODE	53
11.1.2 QUICK MODE	53
11.2 SONGS	53
11.2.1 SONG EDIT MENU	53
11.2.2 ADDING SONG ROWS AND ASSIGNING PATTERNS AND CHAINS	54
11.2.3 ADDING REPEATS, MUTES AND TRANSPOSE INFORMATION	54
11.2.4 SONG MENU	55
12 GLOBAL MENU	56
12.1 PROJECT	56
12.2 GLOBAL SLOT	56
12.3 MASTER TUNE	56
12.3.1 MASTER TUNE	56
12.4 SEQUENCER CONFIG	56
12.4.1 QUANTIZE LIVE REC	56
12.4.2 KIT RELOAD ON CHG	57
12.5 MIDI CONFIG	57
12.5.1 SYNC	57
12.5.2 PORT CONFIG	57
12.5.3 CHANNELS	58
12.6 CV CONFIG	61
12.6.1 CV A-D CONFIG	61
12.6.2 VOLTAGE TRIM	62
12.7 AUDIO ROUTING	63
12.8 SYSEX DUMP	63

12.8.1 SYSEX SEND.....	64
12.8.2 SYSEX RECEIVE.....	64
12.9 SYSTEM	65
12.9.1 USB CONFIG.....	65
12.9.2 OS UPGRADE	65
12.9.4 CALIBRATION	66
13. STARTUP MENU	67
13.1 TEST MODE	67
13.2 EMPTY RESET.....	67
13.3 FACTORY RESET	67
13.4 OS UPGRADE.....	67
14. MORE ON OSCILLATORS, FILTERS, AND ENVELOPES.....	68
14.1 OSCILLATORS	68
14.1.1 SUB OSCILLATORS.....	68
14.1.2 OTHER OSCILLATOR WAVEFORM SELECTIONS.....	69
14.2 FILTERS	69
14.2.1 4-POLE LADDER FILTER	69
14.2.2 2-POLE MULTI MODE FILTER	69
14.3 ENVELOPES.....	70
15. SETUP EXAMPLES	72
15.1 ANALOG FOUR CONTROL OF AN EXTERNAL ANALOG SYNTHESIZER	72
15.2 ANALOG FOUR WITH OTHER ELEKTRON GEAR.....	73
15.3 ANALOG FOUR AS A FILTER BANK	74
15.4 USING AN EXTERNAL OSCILLATOR WITH THE ANALOG FOUR.....	75
15.5 ANALOG FOUR WITH AN ELECTRIC GUITAR.....	77
16. USEFUL KEY COMBINATIONS (QUICK KEYS)	79
16.1 GENERAL	79
16.2 NAMING	79
16.3 SOUND BROWSER.....	79
16.4 SAVING AND RELOADING.....	79
16.5 MENU ACCESS	79
16.6 SEQUENCER SETTINGS	79
16.7 MUTES	79
16.8 CLEAR TRACK / CLEAR PATTERN.....	79
16.9 SHIFTING TRIGS AROUND	80
16.10 CHAIN EDITING	80
16.11 RANDOMIZE PARAMETERS.....	80
17. TECHNICAL INFORMATION	81
18. CREDITS AND CONTACT INFORMATION	82
APPENDIX A: SYNTH TRACK PARAMETERS.....	83
APPENDIX B: FX TRACK PARAMETERS	89
APPENDIX C: CV TRACK PARAMETERS	94
APPENDIX D: MIDI	97
APPENDIX E: ANALOG FOUR ARCHITECTURE	106
INDEX	107

1. INTRODUCTION

Thank you for choosing the Analog Four. It is a digitally controlled analog synthesizer featuring, among many things, the renowned Elektron step sequencer. The innovative combination of modern technology and tried and trusted ways of sound generation will let you experience the analog realm to its fullest. To make the most of the machine, we recommend you to carefully read this manual. Tutorial videos, found on the Elektron website, are also available. They cover the basics of the Analog Four and are a great complement to this document.

1.1 CONVENTIONS IN THIS MANUAL

We have used the following conventions throughout the manual:

Key names are written in upper case, bold style and bracketed letters. For instance, the key labeled “FUNCTION” on the main panel is called **[FUNCTION]**.

Menu names are written in upper case letters. The OSC 1 menu is an example of that.

Parameter names and certain menu options where settings can be made or actions performed are written in bold, upper case letters. For example, **VOL**.

Upper case letters are used for parameter setting alternatives, for example, OFF, and certain menu settings, like LEGATO.

Messages visible on the screen are written in upper case letters with quotation marks. Like this, “BANK A: CHOOSE PTN.”

Knobs are written in upper case, bold, italic letters. For instance, the knob “Level” is called ***LEVEL***.

LED indicators like the record LED are written like this: <RECORD>.

The following symbols are used throughout the manual:



Important information that you should pay attention to.



A tip that will make it easier for you to interact with the Analog Four.



This symbol is not used, but it shows a nice ear.

2. ANALOG FOUR BACKGROUND

Some things never go out of style. They seem to possess an inner, timeless quality, an objective trait that sets them apart from the rest. Makes them stand out. They can be found in all areas of human activity, throughout history. From science to art, literature to architecture, photography to theatre - works of art embodying the essence of these expressions are found everywhere. Including, of course, within the domain of sound.

Making and shaping sound using analog circuits goes far back in time. Initially used in compositions dating from the first decades of the 20th century, analog circuits were popularized in the 1960s thanks to artists such as Wendy Carlos. Today, they are frequently emulated by both hardware and software. Their legacy is impressive. The analog tone and timbre has become synonymous with appealing sounds. Rightly so. The depth, fullness and slightly skewed characteristics of analog sounds speak directly to us. As the French poet Baudelaire noted: "Irregularity, in other words the unexpected, the surprising, the astonishing, are essential to and characteristic of beauty." (Intimate Journals, 1930).

We at Elektron owe a lot to analog technology. It is in our blood. The Sidstation, our first product, featured an analog filter which was decisive in generating the unique sound of the synth. With the Analog Four we return, in a sense, back to where we started. Only this time we bring the knowledge and experience gained from the development of instruments like the Machinedrum, Monomachine and Octatrack. The result, we can confidently claim, is the best of two worlds. Rich, warm and lucent analog sound, combined with the accuracy and precision only state of the art digital control can achieve. This makes the Analog Four not only a perfect match for our existing product lines - the instrument is also ideal for any modern studio or live setup in need of that inimitable analog sound.

The Analog Four is our contribution to the proud history of analog instruments.

Enjoy the power of true hardware,

The Elektron Team

Analog Four Reference Manual. This manual is copyright © 2024 Elektron Music Machines MAV AB. All reproduction without written authorization is strictly prohibited. The information in this manual may change without notice. Elektron's product names, logotypes, titles, words or phrases may be registered and protected by Swedish and international law. All other brand or product names are trademarks or registered trademarks of their respective holders. This manual for Analog Four OS version 1.52, was last updated October 28, 2024.

3. PANEL LAYOUT AND CONNECTORS

3.1 FRONT PANEL

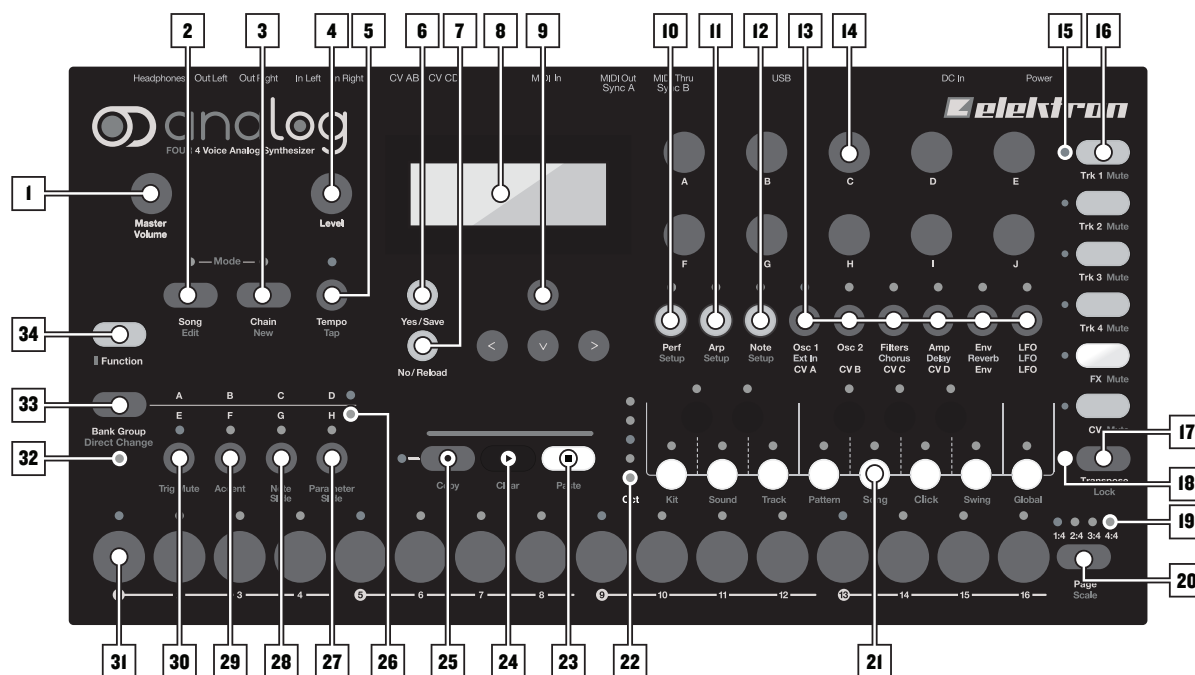

1. **MASTER VOLUME** sets the volume for the main outputs and the headphones output.
2. **[SONG MODE]** activates/deactivates SONG mode.
3. **[CHAIN MODE]** activates/deactivates CHAIN mode.
4. **LEVEL** sets the overall volume level of the active track. Also used for scrolling in menus and setting various parameter values.
5. **[TEMPO]** opens the TEMPO menu. **[FUNCTION] + [TEMPO]** makes it possible to tap the tempo.
6. **[YES/SAVE]** key. Used for entering sub-menus and for confirming choices.
7. **[NO/RELOAD]** key. Used for exiting an active menu and backing one step.
8. The LCD screen.
9. The **[ARROW]** keys. Used for menu navigation. They are called **[UP]**, **[DOWN]**, **[LEFT]** and **[RIGHT]**.
10. **[PERF]** enters PERFORMANCE mode.
11. **[ARP]** key. Opens the ARPEGGIATOR menu that contains arpeggiator settings for the active track.
12. **[NOTE]** key. Opens the NOTE menu that contains general note settings for the active track.
13. **[PARAMETER]** keys switch between the PARAMETER pages of the active track. The upper white text legend indicates the pages for the four synth tracks. The gray text is for the FX track pages and the white text line beneath indicates the CV track pages. A second press on the **[PARAMETER]** key will open secondary PARAMETER pages. <PARAMETER> LED indicates if the first (red) or second (green) page is active.
14. **DATA ENTRY** knobs. Used for adjusting parameters.
15. <TRACK> LEDs indicating the active track and muted tracks.
16. The **[TRACK]** keys select the active track. Four synth tracks, one FX track and one CV track are available. **[FUNCTION] + [TRACK]** mutes a track.
17. **[TRANSPOSE]** transposes the octave for the mini-keyboard and the note trigs.
18. The <TRANSPOSE> LED indicates if the transpose lock functionality is activated or not.
19. <PATTERN PAGE> LEDs indicate how many pattern pages the active pattern consists of and which pattern page is currently active. The LED flashes on the pattern page that is currently playing.

20. **[PAGE]** selects the active pattern page in GRID RECORDING mode. The active pattern page is indicated by the four LEDs above the key. The secondary function accesses the SCALE menu. Pressing this key also activates FILL mode (when GRID RECORDING mode is not active).
21. **[KEYBOARD]** buttons are used for playing sounds and assigning note values to note trigs. The first key is called **[KEYBOARD C1]**. The secondary functions of the **[KEYBOARD C1]** through to **[KEYBOARD C2]** keys are the KIT, SOUND, TRACK, PATTERN, SONG, CLICK, SWING, and GLOBAL menus.
22. <OCTAVE> LEDs shows the octave transposition for the **[KEYBOARD]** keys.
23. **[STOP]** stops playback. The secondary function is a paste operation.
24. **[PLAY]** starts the playback of the sequencer. The secondary function is a clear operation.
25. **[RECORD]** key. Activates/deactivates GRID RECORDING mode. Press **[RECORD]** + **[PLAY]** to activate LIVE RECORDING mode. Press **[RECORD]** + **[STOP]** to activate STEP RECORDING mode. The secondary function is a copy operation.
26. <BANK GROUP> LED indicates if bank group A-D or E-H is accessed.
27. **[BANK D/H]** accesses pattern selection for either bank D or H. The secondary function opens the PARAMETER SLIDE menu.
28. **[BANK C/G]** accesses pattern selection for either bank C or G. The secondary function opens the NOTE SLIDE menu.
29. **[BANK B/F]** accesses pattern selection for either bank B or F. The secondary function opens the ACCENT menu.
30. **[BANK A/E]** selects a pattern in either bank A or E. The secondary function opens the TRIG MUTE menu.
31. **[TRIG]** keys are used for entering trigs to the sequencer. Also used for choosing patterns.
32. <PATTERN MODE> LED indicates the selected PATTERN mode: sequential (off), direct start (red) or direct jump (green).
33. **[BANK GROUP]** key selects the active bank group (A-D or E-H). The secondary function activates different PATTERN modes.
34. **[FUNCTION]** key. Press and hold for accessing secondary functions for some of the other keys. Secondary functions are written in red text on the panel.

3.2 REAR CONNECTORS

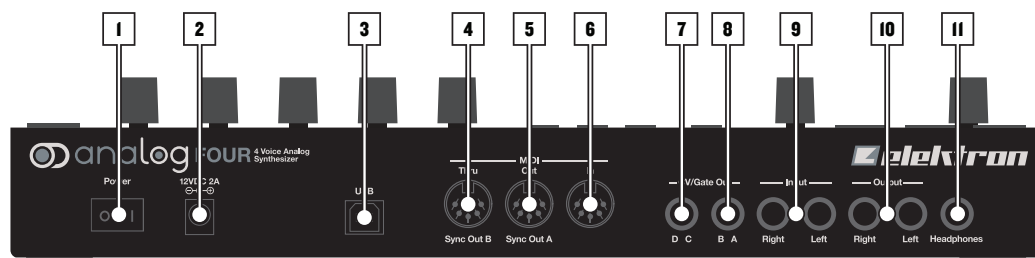

1. **Power on/off switch.**
2. **12 V DC power in.** Use the included Elektron PSU-3 power adapter, connected to a power outlet.
3. **Full Speed USB 2.0 connection.** Use an A to B USB 2.0 connector cable to a computer host.
4. **MIDI Thru.** Forwards data from MIDI IN. Use a standard MIDI cable to connect another MIDI device in the chain.
5. **MIDI Out.** MIDI data output. Use a standard MIDI cable to connect to MIDI In of an external MIDI device.
6. **MIDI In.** MIDI data input. Use a standard MIDI cable to connect to MIDI Out of an external MIDI device.
7. **CV outputs C and D.** Connect to external synth with CV inputs. Use either standard 1/4" mono phone plug or 1/4" insert/Y cable.
8. **CV outputs A and B.** Same recommended connectors as above.
9. **Audio Input L/R.** Use standard 1/4" mono phone plug to input sound from other synthesizers or mixers.
10. **Main Out L/R.** Use either 1/4" mono phone plug (unbalanced connection) or 1/4" stereo (Tip/Ring/Sleeve) phone plug (balanced connection).
11. **Headphones Output.** Audio output for stereo headphones. Use 1/4" (Tip/Ring/Sleeve) phone plug.



Use the included PSU-3 with your Analog Four. It can, using an appropriate power cord, be used all over the globe without the need of voltage converters. Using the wrong type of adapter may damage your unit. Damage caused by the use of incorrect power supply is not covered by warranty. For more information, please see “17. TECHNICAL INFORMATION” on page 81.

3.3 ANALOG FOUR ACCESSORIES

3.3.1 RACK MOUNT KIT

When rack mounted, the Analog Four occupies four standard height units plus additional space, usually about 1 U, which is needed to accommodate cables plugged into the unit. A 1 U empty rack space below the Analog Four is recommended for ventilation purposes.

When assembling the rack mount kit, make sure that you have a Phillips screwdriver of the right size. Use the included M3 x 6 mm size screws to secure the rack mount consoles on each side of the Analog Four.

3.3.2 ECC-2 CARRYING BAG & PL-2 PROTECTIVE LID

The carrying bag accommodates one Analog Four. The protective plastic lid is put on top of the Analog Four panel and protects the LCD and the knobs. The protective lid is included with the bag, but can also be purchased separately.

3.4 CONNECTING THE UNIT

Make sure you place the Analog Four on a stable support, such as a sturdy table with sufficient cable space, or mount in a rack according to the instructions above. Before you start connecting the Analog Four to other units, make sure all units are switched off.

1. Plug the supplied DC adapter to a power outlet and connect the small plug to the 12 V DC connector of the Analog Four unit.
2. Connect the main out L/R from the Analog Four to your mixer or amplifier.
3. If you want to use MIDI, connect MIDI OUT from the Analog Four to the MIDI IN of the device you wish to send data to. Connect the MIDI IN of the Analog Four to the MIDI OUT of the device you wish to receive data from. The MIDI THRU port “echoes” the data arriving at the MIDI IN port, and is used for chaining MIDI units together.
4. Switch on all units. Switch on the Analog Four by pressing the Power switch located at the back of the unit. Before restarting the unit, wait 2 seconds after the LCD backlight goes out.

4. ANALOG FOUR SIGNAL PATH

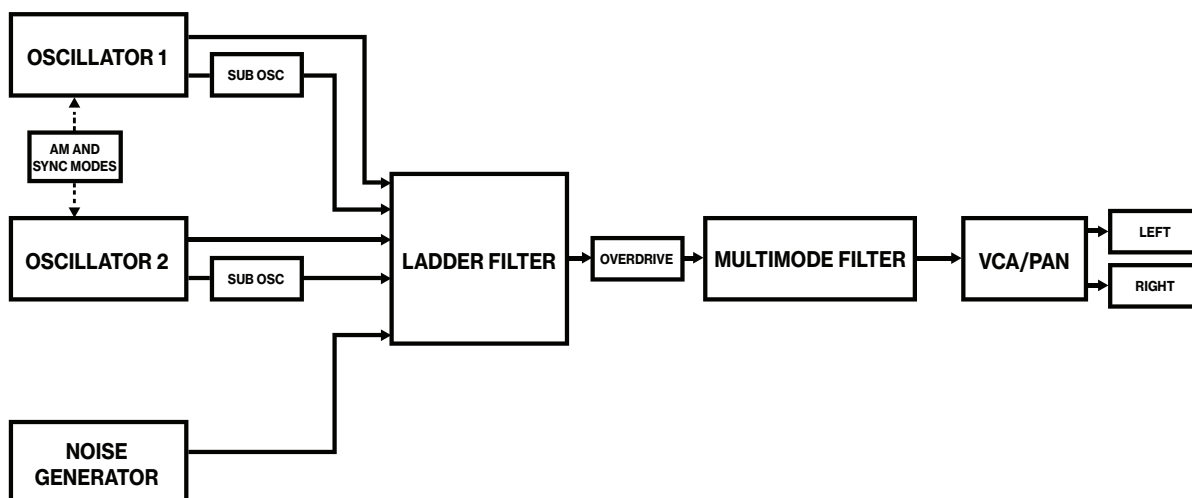

4.1 ABOUT THE COMPONENTS

Both oscillators of each voice are analog. All their elaborate waveshaping abilities are completely analog, with digitally controlled pitches. The noise generator is digital. The two filters and the overdrive circuit between them are fully analog. The amplifiers are analog. The envelopes and LFOs are digital. They are designed for maximum efficiency and versatility.

4.1.1 COMMENTS ON THE SIGNAL PATH

The signal path from the oscillators to the audio outputs is completely analog. The signal path from the external inputs to the audio outputs is also fully analog. The digital send effects are parallel to the main audio path, and the wet signals from the digital send effects are mixed with the dry analog signal before the main output stage.

4.1.2 ABOUT THE OSCILLATORS AND FILTERS

The oscillators are designed and built from scratch, to obtain a lush sound and provide an array of control features. The ladder filter utilizes discrete low-noise transistors, and the multimode filter uses high-quality VCAs. The combination of tradition and innovation ensures a unique sound with a broad range of possibilities. For more information, please see “APPENDIX E: ANALOG FOUR ARCHITECTURE” on page 106.

5. OVERVIEW OF THE ANALOG FOUR STRUCTURE

The image below outlines the data structure of the Analog Four.

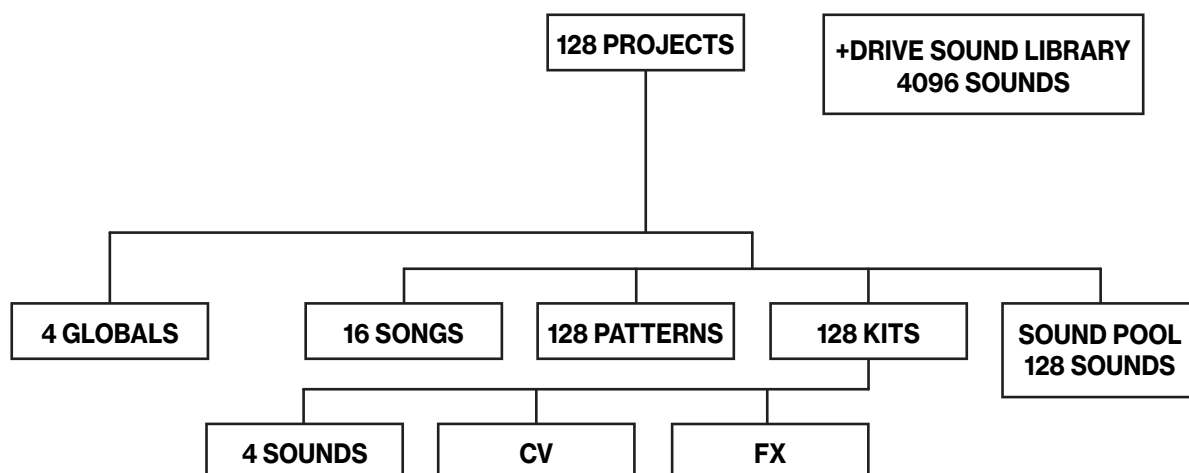

5.1 +DRIVE

The +Drive is a non-volatile memory capable of storing up to 128 projects (thousands of patterns, kits, and songs) internally. The +Drive also gives access to the +Drive Sound library, with the capacity of storing 4096 Sounds. Every project has access to these Sounds.

5.2 DATA STRUCTURE

5.2.1 PROJECT

A project contains 128 patterns, 128 kits, 16 songs, 4 global slots, and a project Sound pool consisting of up to 128 Sounds. Generic settings and states (tempo, mutes et cetera) are also stored in each project. A project becomes the active working state of the Analog Four once it's loaded. From here it is possible to edit the patterns, kits, songs, and globals of the project. The Analog Four always retains the active working state, the active project, even when switched off. However, it must be manually saved in a project slot before another project is loaded or it will be lost. Projects are saved, loaded et cetera in the GLOBAL menu. For more information, please see "8. PROJECTS" on page 23.

5.2.2 KIT

Kits contain four Sounds, one for each synth track, and settings for the FX and CV tracks. Up to 128 kits are available for each Analog Four project. Each pattern is linked to a kit. For more information, please see "9. KITS AND SOUNDS" on page 25.

5.2.3 SOUND

A Sound consists of stored synth track parameter settings. Each synth track can host one Sound. Sounds can be stored either in the Sound pool of the active project or the +Drive Sound library. The Sound pool contains 128 Sounds and the +Drive library can consist of 4096 Sounds. For more information, please see "9. KITS AND SOUNDS" on page 25.

5.2.4 BANK

Eight banks exist for each project and each bank contains 16 patterns. For more information, please see "10. THE SEQUENCER" on page 38.

5.2.5 PATTERN

For each of the 8 banks, 16 patterns are available, which means 128 patterns are always available. A pattern consists of sequencer data like trigs, parameter locks, time signature and individual track length for the synth tracks and the FX and CV tracks, as well as ARP page and NOTE menu settings. For more information, please see "10. THE SEQUENCER" on page 38.

5.2.6 SONG

16 songs are available for each project. They are used to structure the playback of patterns. For more information, please see "11.2 SONGS" on page 53.

5.2.7 CHAINS

A chain is a sequence of patterns. Up to 256 pattern slots are possible to allocate between 64 chains. For more information, please see “11.1 CHAINS” on page 53.

5.2.8 GLOBAL

The GLOBAL menu is where you save, load and manage projects, handle SysEx data and perform OS upgrades. It also contains general settings for the synth and sequencer as well as MIDI and CV configurations. Four global slots are available for every project, each with its own settings. For more information, please see “12 GLOBAL MENU” on page 56.

5.3 ABOUT THE TRACK TYPES

5.3.1 THE SYNTH TRACKS

The synth tracks consist of tracks 1-4. To edit one of them, press [TRACK] key 1-4. Sounds are loaded to the synth tracks. Sounds can be played polyphonically.

5.3.2 THE FX TRACK

The FX track controls the Analog Four internal send effects. To edit the FX track, press the [TRACK 5] key.

5.3.3 THE CV TRACK

The CV track is used for controlling external equipment capable of receiving analog CV and Gate signals. To edit the CV track, press [TRACK] key 6.

5.3.4 EDITING THE TRACKS

The six [PARAMETER] keys open pages for editing the tracks. They contain different parameters depending on the track type. Edit parameters using the *DATA ENTRY* knobs. Press and turn a knob to adjust parameters in larger increments.

6. INTERACTING WITH THE ANALOG FOUR

The center of Analog Four editing is the LCD display. The main interface screen is shown below:

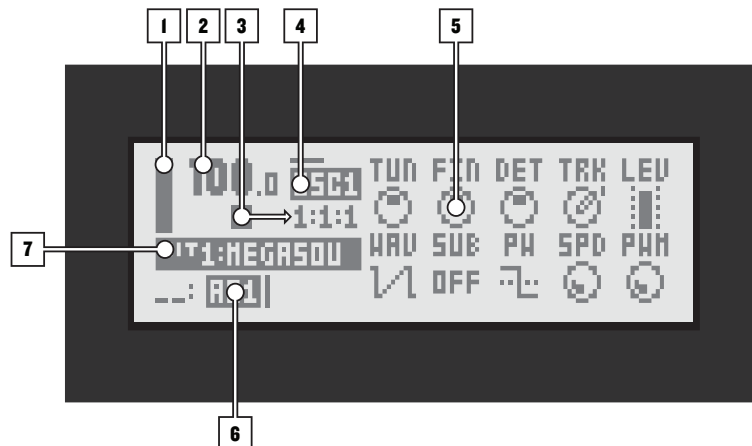

1. Bar indicating the main volume setting of the active track.
2. The current tempo displayed with one decimal.
3. The playback/recording status of the sequencer shown by the standard “record”, “play”, “pause” and “stop” symbols; ■, ■, ■, and ■. To the right is a counter displaying how many bars, beats, and steps the sequencer has played.
4. Information about which PARAMETER page is active. The line above the text indicates the active sub page of the PARAMETER page. A fully drawn line means no sub page is available.
5. Up to ten track parameters. They show what the *DATA ENTRY* knobs control and also indicate the current parameter values. Press and turn a knob to adjust its parameters in larger increments.
6. The currently active pattern. To the left the active song row is visible. A “_ _:” representation indicates the scratch pad row is active.
7. The currently active kit. When turning a *DATA ENTRY* knob, the full name of the adjusted parameter is shown here.



All windows can be closed using the [NO/RELOAD] key.

Buttons or knobs not used by an active menu retain their original function. For example, the TEMPO menu makes use of the LEVEL knob, but you can still use the *DATA ENTRY* knobs to control the parameters of the active track.

6.1 PARAMETER EDITING

The *DATA ENTRY* knobs are used to change the value of the track parameters. The physical location of the knobs on the front panel correspond to the layout of the parameters on the screen.

6.1.1 QUICK PARAMETER EDITING

If the *DATA ENTRY* knob is pressed down while being turned parameters will be adjusted in larger increments. This makes it much quicker to sweep through a whole parameter range.

6.1.2 PARAMETER VALUE JUMP

Keeping [FUNCTION] pressed while editing certain parameters will make the parameter values jump to relevant positions. For example the oscillator tuning, which will jump in octaves.

6.2 [FUNCTION] KEY PRESS COMBINATIONS

The standard way to use the [FUNCTION] key in combination with other keys, is to press and hold [FUNCTION] and then make a short press on the second key in the combination. For some key combinations it is also possible to access a sub-menu by pressing and holding [FUNCTION] + second key for a second.

6.3 QUICK SCROLLING

In most menus quick scrolling is available. Press [FUNCTION] + the [UP] or [DOWN] arrow keys to move the cursor one menu page at a time.

6.4 COPY, CLEAR AND PASTE

Copy, clear and paste commands are available in a lot of contexts. A copy operation is performed by pressing **[FUNCTION] + [RECORD]**. A paste operation is performed by pressing **[FUNCTION] + [STOP]**. A clear operation is performed by pressing **[FUNCTION] + [PLAY]**. Paste and clear operations can be undone by repeating the button press combination. For more information, please see “10.12.11 COPY, PASTE, AND CLEAR OPERATIONS” on page 51.

6.5 THE NAMING MENU

The naming procedure is identical for the various naming menus that exist.

ENTER SOUND NAME
 001: M Y SOUND 1 

The **[LEFT]** and **[RIGHT]** arrow keys are used to navigate between the letters. Turning the **LEVEL** knob or pressing the **[UP]** or **[DOWN]** arrow keys select the letter. **[FUNCTION] + [NO/RELOAD]** will erase letters.

6.5.1 POP-UP MENU NAMING

While in a NAMING menu it is possible to open a pop up-menu displaying all available letters, symbols and digits. Entering characters in the pop up-menu is often a considerably faster naming method. When a NAMING menu is open, press the **[FUNCTION]** key to access the pop up-menu.

A B C D E F G H I J K L
 M N O P Q R S T U V W X
 Y Z + - = % / # @ ? * &
 0 1 2 3 4 5 6 7 8 9 ^

While keeping **[FUNCTION]** pressed use the **[ARROW]** keys to navigate to the character you want to insert. Once there, release **[FUNCTION]** to insert the character.



Copy, paste, and clear commands are available in the naming menus.

6.6 OVERBRIDGE

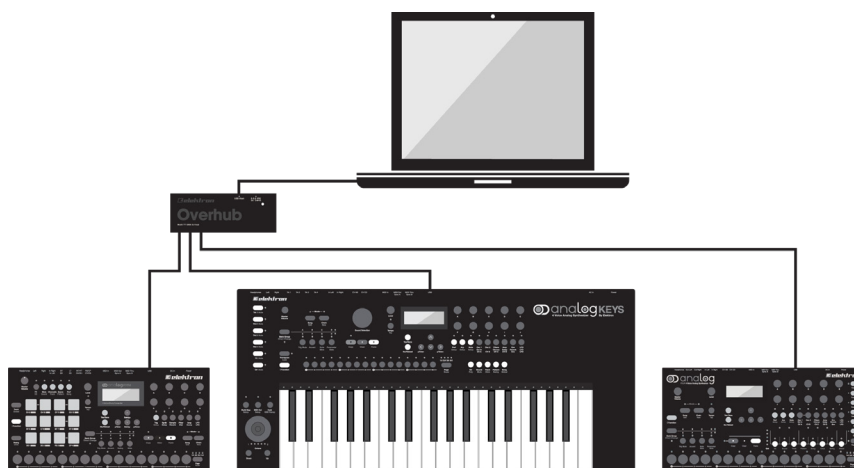

This manual primarily focuses on how to use the Analog Four as a standalone instrument. But you can also use Overbridge to interact with the Analog Four. The Overbridge software suite enables a tight integration between the Analog Four and a computer DAW.

When using the Overbridge setup, the user interface for your device will present itself as a clearly laid out plugin window in your DAW. Enjoy multitrack audio, browse through and organize sounds, edit kits, even set

6. INTERACTING WITH THE ANALOG FOUR

up the CV communication via a simple point-and-click workflow. Access all parameters for sound shaping, including oscillator settings, filters, amp, envelopes, and LFOs, on screen at once. Always find your device settings in the same state as you left them when you return to your DAW project, with the convenient, optionally automatic, Machine State Total Recall functionality.

You need an Analog Four, a USB cable, a computer running Overbridge, and a DAW.

If you want to hook up multiple machines to a computer, you must use a USB hub. We suggest the Elektron Overhub, tailored for Overbridge use. It is Multi-TT hub and thereby also supports older Elektron machines.

Overbridge is available as a complimentary download on the Elektron website. Please read the Overbridge manual (also available on the Elektron website, Support section) to learn more about its uses and capabilities.

Once installed, for Overbridge to work together with your Analog Four, do the two following two things:

First - Make sure the OS of your Analog Four, and the OS of Overbridge, match. Simply put, always have the most recent OS installed on both computer and device. You find the latest versions of both operating systems included with the Overbridge Suite download package.

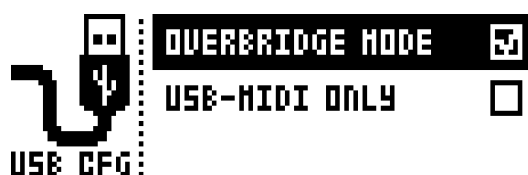

Second - set your Analog Four device to Overbridge mode. You will find this setting in the GLOBAL > SYSTEM > USB CONFIG menu. Press [YES] to tick the OVERBRIDGE box. For more information, please see “12.9.1 USB CONFIG” on page 65.

For more detailed information about installing and using Overbridge, please see the Overbridge User Manual that you can download from the Elektron website.

6.7 BACKING UP THE ANALOG FOUR

It is always recommended to make regular backups of your data. Backups are also a convenient way to share your projects and Sounds with other users. To make backups and transfer files to and from your Elektron device, you should use Transfer, a free application that you can download from the Elektron site <https://www.elektron.se/support>. The application is available for both Windows and macOS.

6.8.1 BACKING UP PROJECTS AND SOUNDS

You can backup up your projects and Sounds from your Elektron device to a computer. Here is the general procedure for how to back up your device:

1. Connect the Elektron device to the computer via USB.
2. Open the Transfer application on your computer, and then select the USB MIDI port(s) for your device on the CONNECTION page, and then click “CONNECT” next to your device under AVAILABLE DEVICES.
3. In Transfer, click the EXPLORE tab to open the EXPLORE page.
4. On the EXPLORE page top left side of the drop-down menu, make sure “MY COMPUTER” is selected.
5. On the top right side, in the drop-down menu, select the type of file you want to transfer.
6. In the window on the right, navigate to the files or folders you want to transfer
7. Drag and drop the files or folders to your preferred location under “MY COMPUTER.”

6.8.2 TRANSFERRING BACKED UP FILES TO YOUR ELEKTRON DEVICE

Use the EXPLORE page in Transfer to transfer previously backed up files to your Elektron device from a computer.

1. Connect the Elektron device to the computer via USB.
2. Open the Transfer application on your computer and then select the USB MIDI port(s) for your device on the Transfer CONNECTION page. Click “CONNECT” (or click “CONNECT” next to your device under AVAILABLE DEVICES.
3. In Transfer, click the EXPLORE tab to open the EXPLORE page.
4. On the top right side, in the drop-down menu, select the type of file you want to transfer.

5. On the top left side in the drop-down menu, make sure “MY COMPUTER” is selected.
6. Under “MY COMPUTER,” navigate to the files or folders you want to transfer.
7. Drag and drop the files or folders to your preferred location on your device.
8. Depending on what file type you send, you might encounter pop-up windows asking you to decide what files you want to send and how you want to organize them.

7. QUICK START

This quick start will guide you through some of the basic operations to allow you to start using the Analog Four right away. First, you need to connect it. For more information, please see “3.4 CONNECTING THE UNIT” on page 14.

7.1 PLAYING THE FACTORY PRESETS

The Analog Four is shipped with several preset patterns, kits, and Sounds. To immediately start experimenting with the Analog Four, just follow the instructions below.

1. Switch on the Analog Four.
2. Press **[PLAY]** to listen to pattern A01.
3. Select pattern A02, which is the second demo pattern, by first making sure bank group A-D is selected. The **<BANK GROUP>** indicates the selected bank group. If A-D is not selected, press the **[BANK GROUP]** key.
4. Pressing **[BANK A/E]** + **[TRIG 2]** key will make pattern A02 play once the currently playing pattern finishes. Pattern A03 is selected by pressing **[BANK A/E]** + **[TRIG 3]** key and so on.
5. Mute tracks by pressing **[FUNCTION]** + the **[TRACK]** key of the track you want to mute. Unmute by repeating the procedure.
6. Press **[STOP]** to stop playback.

7.1.1 PERFORMANCE MODE

The PERFORMANCE mode makes it possible for the **DATA ENTRY** knobs to control several PARAMETER page parameters at once. These parameter mappings are called a parameter macro.

1. Make sure a pattern is playing.
2. Press the **[PERF]** key to access PERFORMANCE mode.
3. Turn the **DATA ENTRY** knobs and listen to how the sound of the pattern changes.

7.1.2 ADJUSTING PARAMETERS

Each track contains six PARAMETER pages. There you can find the parameters that affects the sound.

1. Make sure a pattern is playing.
2. Press the **[TRACK]** key of one of the four synth tracks.
3. To change the cutoff of the ladder filter, press the **[FILTERS]** key. The FILTERS page will open. The parameter labeled **FRQ** changes the cutoff of the ladder filter. Turn **DATA ENTRY** knob **A** to change the parameter value.
4. Try out the rest of the PARAMETER page parameters to experiment with the sound shaping possibilities.
5. To reload the Sound to its original state, press **[NO/RELOAD]** + **[KEYBOARD D1]**.
6. To reload the whole kit to its original state, press **[NO/RELOAD]** + **[KEYBOARD C1]**.

8. PROJECTS

A project is the top level structure of the Analog Four. A project contains 128 patterns, 128 kits, 16 songs, 4 global slots, and a project Sound pool consisting of up to 128 Sounds. Projects are handy when for example wanting to save a specific setup for a live performance or for managing a select number of compositions. The +Drive can store 128 projects.

When a project is loaded it becomes the active working state of the Analog Four, independent of the +Drive. Analog Four will keep track of what project slot the active project was loaded from. When a project is loaded, it is possible to edit its patterns, kits, songs, and globals. The active project and any changes made to it are automatically remembered by the Analog Four, allowing you to edit patterns, kits et cetera, switch off the unit, switch it on again and have everything sound as it did before the power cycling. Please note that changes are not automatically written to the +Drive. You need to save the project manually to store the active working state of the project to a +Drive slot.

8.1 PROJECT MENU

You manage your Projects in the PROJECT menu, located in the GLOBAL menu. Open the GLOBAL menu by pressing [FUNCTION] + [KEYBOARD C2].



Scroll the list by using [UP]/[DOWN] or the *LEVEL* knob and select PROJECT. Open the menu by pressing [YES/SAVE].



8.1.1 LOAD PROJECT

Opens a project selection screen where you choose a project to be loaded. Note that the active project will not be automatically saved when you load a new project. This menu can be accessed directly by pressing and holding [FUNCTION] + [KEYBOARD C2] for a second. If you wish to create a new project, select CREATE NEW at the very bottom of the list. The new project will be a blank slate.



8.1.2 SAVE PROJECT

Opens a project selection screen where you choose a slot to save the active project to.





A small arrow in front of the project name indicates the slot that the currently active project is linked to.

Projects can be copied/cleared/pasted in the **LOAD PROJECT** and **SAVE PROJECT** menus.

A lock symbol indicates the project is write protected.

8.1.3 PROJECT MANAGER

Opens the **PROJECT MANAGER** menu. Selecting a project in this menu and pressing the **[RIGHT]** arrow key will bring up a list of commands.



CLEAR resets the project slot to a clean state.

INIT NEW initializes an empty file slot with a clean project. This operation is only available for empty project slots.

DELETE removes the project from the slot.

RENAME opens a screen where you can rename the project.

LOAD FROM loads the selected project to the active project.

SAVE TO saves the active project to the selected slot.

TOGGLE toggles write protection on or off. Write protected projects can not be overwritten, renamed or erased. A lock symbol indicates a write protected project.



Multiple projects can be selected and deselected by highlighting them and pressing **[YES/SAVE]**.

The slot the currently active project is linked to is indicated by a small arrow in front of the project name.

Projects can be copied/cleared/pasted in this menu.



LOAD FROM in the **PROJECT MANAGER** will overwrite the active project. Be sure to save your project before you load another.

9. KITS AND SOUNDS

Kits and Sounds are the basic building blocks of Analog Fours sound crafting. A kit is a collection of Sound, FX, and CV track parameter settings. A Sound is essentially a synth track patch, made up by subtractive synthesis from the oscillators through the filters via its various parameter settings. Each of the 4 synth tracks contains one Sound.

Kits and Sounds are separated, meaning kits do not necessarily have to use any saved Sounds. When saving a kit, the PARAMETER page settings of the synth tracks, i.e. the settings that constitute a Sound, will be saved together with the kit. The synth track PARAMETER page settings of a kit can be saved as individual Sounds as well. When loading a Sound, it will become a part of the kit. Changes made to the track Sound will not affect the saved Sound on the +Drive, only the kit. A kit is always assigned to a pattern which controls the playback of the kit.

A Kit contains:

- Sound settings for the 4 synth tracks.
- FX track parameter settings.
- CV track parameter settings.
- LEVEL settings for the Synth and FX tracks.
- PERFORMANCE mode parameter settings.
- Polyphony settings.

A Sound contains:

- Settings for the PARAMETER pages of a synth track.



The LCD graphics in the left part of the screen shows the name of the currently active kit. When you press th [TRACK] keys, this information briefly changes to reflect the name of the track. The name of the track Sound will be displayed for the synth tracks.



Note that several patterns may use the same kit. Changes you make to the kit while editing one of the patterns will directly affect how the other patterns sound as well. Remember to save the kit to a new location if you wish to avoid this.

9.1 THE +DRIVE SOUND LIBRARY AND THE SOUND POOL

Sounds can be loaded to a kit from either the +Drive Sound library or the Sound pool of the active project. The difference between the two is that the +Drive Sound library has the capacity of 4096 Sounds, available to all projects, while a Sound pool is a part of a project and limited to 128 Sounds. The primary benefit of Sounds loaded to the Sound pool is the possibility for them to be Sound locked. This feature is not available for the Sounds in the +Drive Sound library. For more information, please see “10.12.2 SOUND LOCKS” on page 48.

9.2 KIT MENU

In the KIT menu, commands relating to kits are found, most importantly kit save and load. Open the menu by pressing [FUNCTION] + [KEYBOARD C1]. Use the [UP] and [DOWN] arrow keys to move between the commands. Press [YES/SAVE] to confirm your selection. Exit the menu by pressing [NO/RELOAD].



9.2.1 RELOAD KIT

Will reload either the active kit, reverting it to its saved status, or to all kits. Using the [LEFT] and [RIGHT] keys selects whether only the active kit or all kits should be reloaded. [NO/RELOAD] + [KEYBOARD C1] offers a short cut to reloading the active kit.

9.2.2 LOAD KIT

Opens a menu where you can load one of the up to 128 saved kits. The kit list will appear when you open this menu. Inverted graphics indicates the active kit. Use the [ARROW] keys or the LEVEL knob to select

the kit you wish to load. [LEFT]/[RIGHT] will quickly scroll between the menu pages. Select a kit, and then press [YES/SAVE] to load it. The loaded kit is linked to the active pattern. If you load the active kit it will be reload from last saved state. Kits that are not associated with any pattern are distinguished by a star symbol after the kit name.

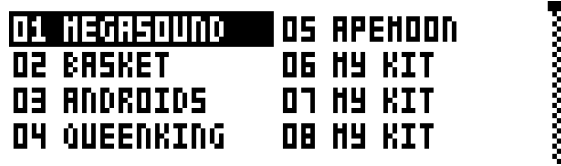

9.2.3 SAVE KIT

This is where all the current, kit related settings can be saved as a kit. The saved kit is linked to the active pattern. [YES/SAVE] + [KEYBOARD C1] offers a short cut to this command.

The kit list appears when you open this menu. Inverted graphics indicates the active kit. Use the [ARROW] keys or the LEVEL knob to select the slot to where the kit will be saved. Press [YES/SAVE] to save to the selected slot. The NAMING menu, covered on page 10, appears to give you the option to name the kit.

9.2.4 CLEAR KIT

Clears the content of the currently loaded kit, basically initializing it. A prompt appears when you select this option. Press [YES/SAVE] to clear the kit or [NO/RELOAD] to cancel the operation. Note that no kit information will be permanently lost until the kit is saved to the same kit slot as it was loaded from.

9.2.5 PERFORMANCE

Opens the PERFORMANCE SETUP menu. For more information, please see “9.3.1 PERFORMANCE SETUP” on page 27.

9.2.6 POLY CONFIG

Opens the POLYPHONY CONFIGURATION menu. For more information, please see “9.4.1 POLYPHONY CONFIGURATION” on page 28.

9.2.7 VOICE ROUTING

Accesses VOICE ROUTING. For more information, please see “9.2.7 VOICE ROUTING” on page 26.



Copy, clear and paste operations are available in the LOAD KIT, SAVE KIT and PERFORMANCE SETUP menus.

Press and turn the LEVEL knob to increase scrolling speed in the LOAD KIT and SAVE KIT menus.

Once you have assembled a kit you like, you are advised to save it.

An asterisk after the kit name indicates kits that are not used by any pattern.

9.3 PERFORMANCE MODE

The PERFORMANCE mode makes it possible to control five track parameters, which can be chosen from any track, at the same time by turning a single DATA ENTRY knob. This is called a performance macro. Track muting and an overview of all synth and FX track levels are available in this mode as well. The PERFORMANCE mode settings are saved as a part of a kit.

Access the PERFORMANCE mode by pressing the [PERF] key.



The ten available performance macros are seen in the PERFORMANCE menu. Turn the DATA ENTRY knobs to adjust the parameter macro settings. The graphics indicating the active kit will briefly change to reflect the mute status of the tracks.

9.3.1 PERFORMANCE SETUP

The PERFORMANCE SETUP menu is used to set up the ten performance macros available in the PERFORMANCE mode. Access this menu by pressing [FUNCTION] + [PERF].



The collection of all ten performance macros can be copied, cleared and pasted while in this menu.

9.3.2 PERFORMANCE CONFIGURE

Here is where you assign parameters to the performance macros. When you select this option, the list of performance macros and the knobs they are assigned to, are displayed. In this menu, individual performance macros can be copied, cleared and pasted.



Use the [UP] and [DOWN] arrow keys to select the *DATA ENTRY* knob corresponding to the performance macro that is edited. Press [YES/SAVE] to confirm the selection. The menu where track parameters are assigned to the selected performance macro will be displayed.



Up to five track parameters can be assigned to a performance macro. Parameters can be selected from all six tracks. Select from which tracks parameters will be assigned by click-pressing *DATA ENTRY* knobs A-E. Select the track parameters that will be assigned by turning *DATA ENTRY* knobs A-E. Confirm a selection by clicking the knob or by pressing [YES/SAVE]. *DATA ENTRY* knobs F-J are used to set the depth of the five track parameters. The depth is an offset of the original track parameter value.

By default, the parameter macro knob spans a parameter value range of 0-127. A parameter macro value of 0 will not introduce any changes to the sound. Press the *LEVEL* knob to make the performance macro knob work in a bipolar fashion, meaning the parameter macro value range will go from -64 to +63.

While a pattern or Sound is playing, turn the *LEVEL* knob to preview how the performance macro affects the sound.



PERFORMANCE mode parameters are not possible to parameter lock.



Use parameter macros to affect the most relevant parameters when playing live. By carefully setting up parameter macros you might find that you don't have to leave this mode at all during your live set.

9.3.3 PERFORMANCE RENAME

Allows performance macro knobs to be named. Use the [UP] and [DOWN] arrow keys to select the *DATA ENTRY* knob corresponding to the performance macro that will be named. Press [YES/SAVE] to confirm the selection. The NAMING menu will appear.

9.3.4 PERFORMANCE MUTE

Track muting can also be done while in PERFORMANCE mode. (You can also use standard Track Muting. For more information, please see “9.14 TRACK MUTING” on page 37.) When in PERFORMANCE mode, [TRIG] keys 1-6 mute the tracks. An outlined square in the track mute section and a full bright <TRIG> LED means a track is audible. A minus sign and a quarter-bright <TRIG> LED indicates the track is muted. While holding [FUNCTION] and pressing the six first [TRIG] keys, the mute changes will be held until [FUNCTION] is released. A track that is currently muted, but will be unmuted when [FUNCTION] is released, is indicated by a “+” sign and a half-bright <TRIG> LED. A track that is currently not muted, but will be muted when [FUNCTION] is released, is indicated by an asterisk and a half-bright, blinking <TRIG> LED.

9.3.5 PERFORMANCE MIXER

When PERFORMANCE mode is active, pressing [PERF] will open the PERFORMANCE MIXER menu. In this menu, the level of the tracks can be controlled with DATA ENTRY knobs A-E.

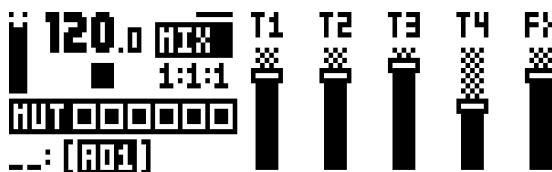

9.4 POLYPHONY

Four voice polyphony can be configured by selecting POLY CONFIG in the KIT menu. The Analog Four is capable of four voice multitimbral polyphony (or unison). This is possible due to the powerful sound engine which is able to change sound instantly and allow completely dynamic voice allocation (see figure below). The sequencer is fully polyphonic, allowing overlapping notes and chords to be programmed on the tracks. Any track can play up to four notes using its track sound. Notes are distributed to the synth voices according to the selected allocation method. Any of the synth voices can also be poly-disabled, allowing tracks to have their dedicated, monophonic synth voice available at all times. The poly configuration is stored per kit, for maximum flexibility, allowing up to 128 different poly configurations per project.

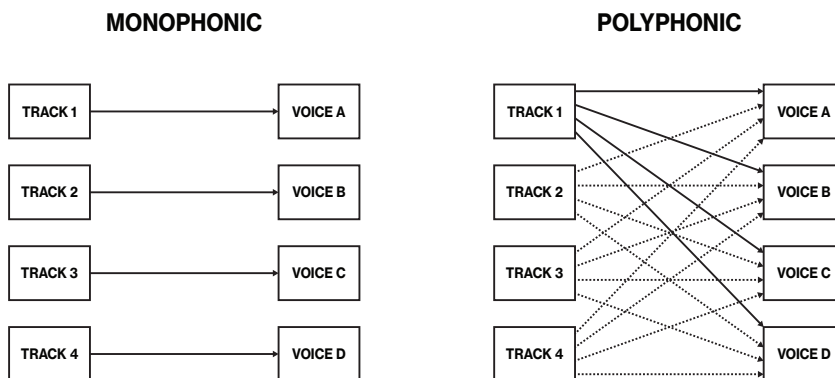

9.4.1 POLYPHONY CONFIGURATION

The settings for up to four voice polyphony are found in the POLY CONFIG menu found at the bottom of the KIT menu (accessed by pressing [FUNCTION] + [C1]).



VOICES Select any combination of the four voices to be poly activated by using the [LEFT] and [RIGHT] arrow keys. Tick or untick a box by pressing the [YES/SAVE] button. To activate/deactivate voice 1-4 directly, press [TRIG] key 1 through 4. When in the POLY CONFIG menu, the red LEDs above [TRIG] key

1-4 on the front panel will be half-bright. When a voice is activated, the corresponding LED will be full-bright. Voices that are not set to be poly enabled will be dedicated monophonic voices for their corresponding tracks. These will never be used for polyphonic playback. Voices that are poly enabled can be allocated dynamically by any of the poly enabled tracks.

ALLOCATION changes the allocation method of the poly voices or sets all poly enabled voices to play simultaneously (RESET, ROTATE, REASSIGN or UNISON, respectively). Select method with the [LEFT] and [RIGHT] arrow keys. For a visual explanation of the different allocation methods, see VOICE ROUTING below.

The LEDs above the first four [TRIG] keys will flash to show voice activity depending on the selected method. Select the method, play a few notes on the keyboard and watch the LEDs to get an immediate, visual impression of how the different allocation methods work.

RESET Picks the first available voice in increasing order, starting from track voice 1, for every new overlapping note played.

ROTATE For every new coinciding note played the voices are allocated cyclically.

REASSIGN Uses the same voice as last time for every note played as long as it is unused. Otherwise, the least recently used voice is used for the new note.

UNISON Uses all voices to play the same note. Employs the adjustable parameters DETUNE and PAN SPREAD shown below.

USE TRK SOUNDS forces the selected voices to use the Sounds of the four tracks, instead of letting the voices dynamically use the played Sound. Tick/untick box to activate/deactivate using the [YES/SAVE] key or the [LEFT] and [RIGHT] arrow keys.

UNISON DETUNE sets the offset (0-127) by which the selected unison voices will be detuned. Decrease or increase the offset with the [LEFT] and [RIGHT] arrow keys.

UNISON PAN SPREAD set the width of the pan spread (0-127) around the center point of the unison sound. Use the [LEFT] and [RIGHT] arrow keys to set the value.

If no free voice is found, the least recently used voice is stolen and used for the played note. See illustration below. This applies to all allocation methods described above.

9.4.2 VOICE ROUTING

Set custom voice routing by accessing VOICE ROUTING, found at the bottom position in the KIT menu.



Activate/deactivate routing of any the four voices to the main output and to the FX track. Navigate using the [ARROW] keys. Tick or untick box with the [YES/SAVE] key.

Alternatively, instantly activate or deactivate voice to main or voice to FX using the [TRIG] keys 1-4 and 9-12, respectively. Red LEDs above these sets of keys will indicate if the voice is active (full-bright) or inactive (half-bright).

Note that voice routing can be set and stored for each KIT. If you want to use the GLOBAL voice routing setting, tick the box USE GLOBAL SETTINGS using the [YES/SAVE] key.



POLYPHONIC VOICE ALLOCATION METHOD: RESET
(SHOWN AS PLAYED FROM TRACK 1)

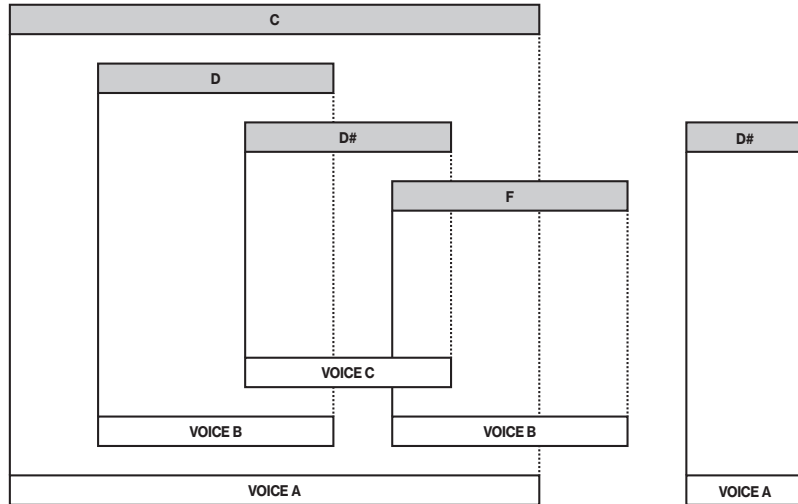
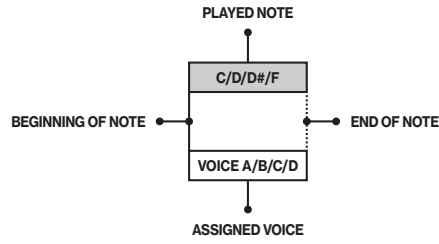

POLYPHONIC VOICE ALLOCATION METHOD: ROTATE

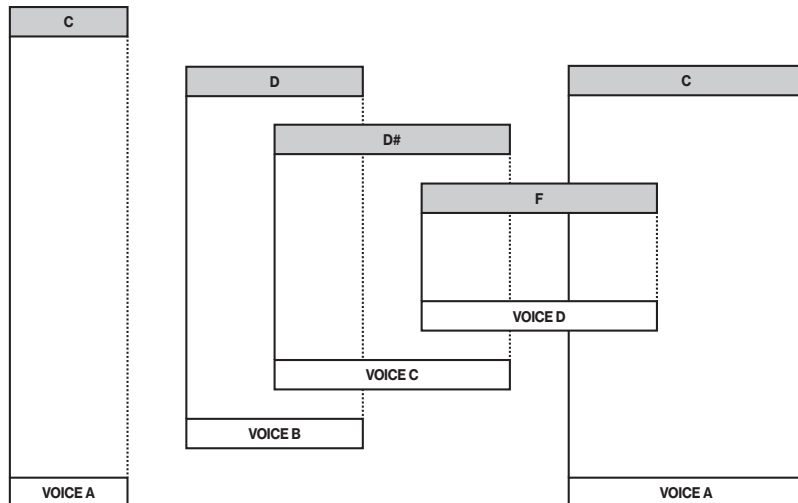
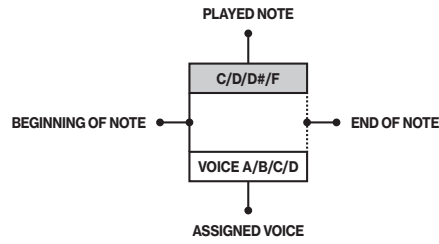

POLYPHONIC VOICE ALLOCATION METHOD: REASSIGN

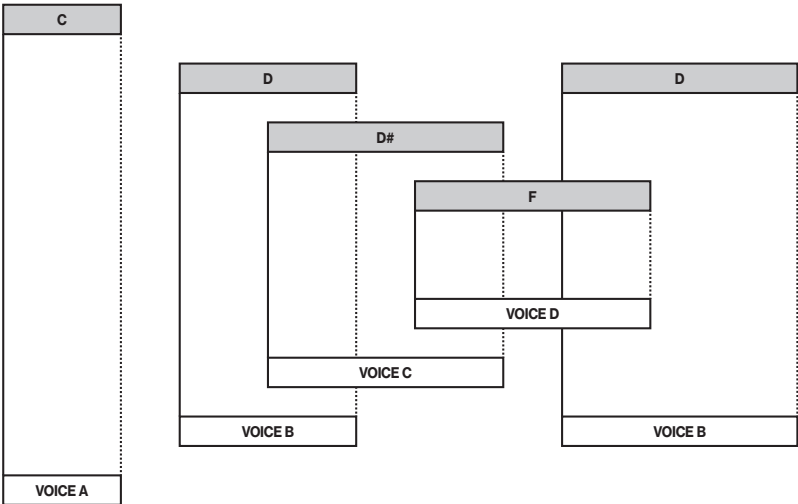
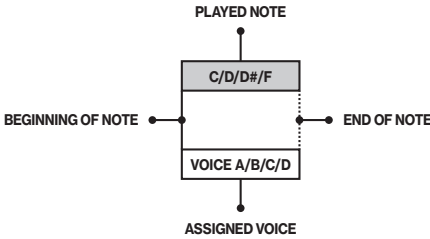

VOICE STEALING

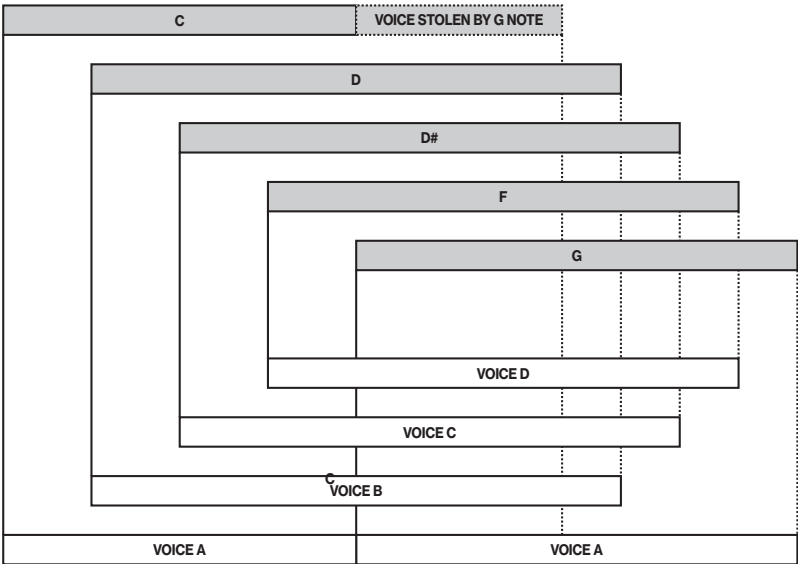
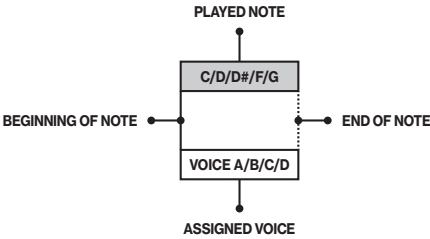

9.5 SOUND MENU

In this menu Sounds in the +Drive Sound library or the Sound pool of the active project can be browsed and managed. Other menu options let you clear the track Sound, rename the track Sound or change the settings for the track Sound. Open the menu by pressing [SOUND]. Use the [UP] and [DOWN] arrow keys to move between the options. Press [YES/SAVE] to confirm your selection. Exit the menu by pressing [NO/RELOAD].

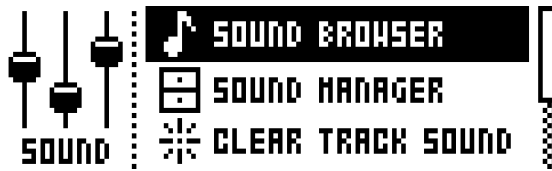

9.6 SOUND BROWSER

The SOUND BROWSER is intended for convenient previewing and loading of Sounds. Opening the menu will show a list of all Sounds residing in either the +Drive Sound library or the Sound pool. Scroll the list by turning the LEVEL knob or by pressing [UP]/[DOWN]. Load a Sound by pressing [YES/SAVE]. Compared to the SOUND MANAGER menu, it lacks the SOUND OPERATIONS menu. Also, empty Sound slots are not shown.



Pressing [LEFT] will access the SORTING menu. Press [YES/SAVE] to execute the commands. Press [NO/RELOAD] or the [RIGHT] arrow key to exit the menu.



9.6.1 VIEW POOL

Lists Sounds available in the Sound pool of the active project. The command is only available when browsing the +Drive Sound library.

9.6.2 VIEW +DRIVE

Lists Sounds available on the +Drive Sound library. The command is only available when browsing the Sound pool of the active project.

9.6.3 SORT ABC

Sorts the Sounds in alphabetical order. The command is only available when slot number is sorting Sounds.

9.6.4 SORT 123

Sorts the Sounds by slot number. The command is only available when Sounds are sorted alphabetically.

9.6.5 FILTER

Opens a list where Sounds can be arranged according to tags. Select and deselect tags by pressing [YES/SAVE]. Multiple tags can be selected. Exit the tag list by pressing [NO/RELOAD].

9.6.6 SEARCH

Performs a text search and list all Sounds with names matching or including the text. See "THE NAMING MENU" on page 10 on how to enter text.



Open the **SOUND BROWSER** instantly by double-pressing [TRACK] key 1, 2, 3 or 4. The **SOUND BROWSER** may also be accessed by pressing and holding [FUNCTION] + [KEYBOARD D1] for a second.

9.7 SOUND MANAGER

The **SOUND MANAGER** can be regarded as a more powerful variant of the **SOUND BROWSER**. Here Sounds can be saved, loaded, tagged et cetera. Opening the menu will show a list of all Sounds residing in either the +Drive Sound library or the Sound pool. Scroll the list by turning the **LEVEL** knob or by pressing [UP]/[DOWN].



Pressing [LEFT] accesses the **SORTING** menu. The available commands are the same as those found in the **SORTING** menu of the **SOUND BROWSER**. For more information, please see “9.6.3 SORT ABC” on page 32.

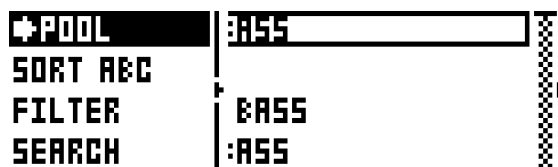

Pressing [RIGHT] accesses the **SOUND OPERATIONS** menu. The available operations will affect the currently highlighted Sound. Press [YES/SAVE] to apply the commands to the selected Sound. Press [NO/RELOAD] or the [LEFT] arrow key to exit the menu.



9.7.1 LOAD TO TRACK

Loads the selected Sound to the active track and makes it a part of the active kit.

9.7.2 COPY TO ...

Copies the selected Sounds to the first free slots of the target storage. The following target storages are available:

- SOUND POOL
- +DRIVE
- BANK A-P

9.7.3 STORE TRACK SOUND

Saves the active track Sound to the selected slot. [YES/SAVE] + [KEYBOARD D1] offers a short cut to this operation.

9.7.4 RENAME

Renames the selected Sound.

9.7.5 EDIT TAGS

Opens a menu where Sounds can be tagged. Sounds can have any number of tags, but only the two first will be shown in the Sound list. Apply or remove tags by pressing [YES/SAVE].

9.7.6 DELETE

Deletes the selected Sounds.

9.7.7 TOGGLE

Enables or disable write protection for the selected Sounds. When a Sound is write protected, it cannot be overwritten, renamed, tagged or deleted.

9.7.8 SEND SYSEX

Sends the selected Sounds as SysEx data.

9.7.9 SELECT ALL

Selects all Sounds in the list.

9.7.10 SELECT UNUSE

Selects all Sounds that are not used in any pattern in the project from the Sound pool. The Sounds are not removed from the +Drive Sound library. Then select DELETE to remove the selected sounds from the project's Sound pool. The SELECT UNUSE command is only available when you browse the Sound pool of the active project.

9.7.11 DESELECT ALL

Deselects all Sounds in the list.



Sounds residing in the +Drive Sound library are organized into 16 banks, ranging from A to P. Each bank can contain 256 Sounds. Use the [TRIG] keys to view only Sounds located in a specific bank.

You can preview the currently selected Sound using the mini keyboard or via the MIDI auto-channel. The Sound is played through the active track. Please note that if the previewed Sound is routed through the effects, the current effects settings will affect it.

Several Sounds can be simultaneously affected by the commands available in the SOUND OPERATIONS menu. Select/deselect individual Sounds by highlighting them and pressing [YES/SAVE].

Press [FUNCTION] + [UP]/[DOWN] for faster scrolling in the Sound list.

9.8 CLEAR TRACK SOUND

Sets the PARAMETER page parameters of the active track to their default values. When selecting this option, a prompt will appear. Press [YES/SAVE] to initialize the parameters or [NO/RELOAD] to cancel the operation. Note that no parameter information will be permanently lost until the kit is saved to the same slot it was loaded from.

9.9 RENAME TRACK SOUND

Opens the NAMING menu where you can rename the Sound of the active track.

9.10 SETTINGS

Opens a menu where various Sound related settings are found. Use the [UP]/[DOWN] arrow keys or the LEVEL knob to scroll in the menu. Use the [LEFT]/[RIGHT] arrow keys to change the settings. The parameters assignable to the controllers (modulation wheel, breath controller et cetera) will vary according to the type of track that is active: Synth, FX or CV.

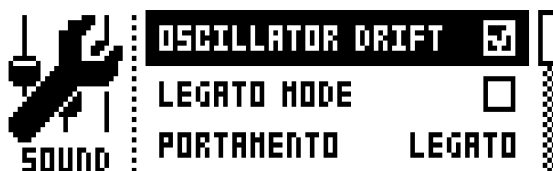

9.10.1 OSCILLATOR DRIFT

Will when activated introduce a very subtle pitch drift to the oscillators, which can increase their perceived “warmth.”

9.10.2 F1 RESONANCE BOOST

Increases the amount of resonance from the first filter. it affects the resonance and gain of both upper and lower frequencies.

9.10.3 VELOCITY TO VOL

Selects how MIDI velocity affects volume when playing the Sound from a MIDI keyboard.

OFF means velocity will not affect the volume of the Sound.

LOG will apply a logarithmic velocity curve. The volume difference will be greater between softer keyboard presses than between harder.

LIN will apply a linear velocity curve. The volume difference between keyboard presses will correspond linearly to the force applied.

EXP will apply an exponential velocity curve. The volume difference will be greater between harder keyboard presses than between softer.

9.10.4 LEGATO MODE

Can be turned either off or on. When the mode is activated, envelopes will not be retriggered for overlapping notes played manually on the **[KEYBOARD]** keys or incoming MIDI notes triggering Sounds. Note that notes on the sequencer are not affected.

9.10.5 PORTAMENTO

Will when active make the pitch slide between notes. The settings only affect notes played manually on the **[KEYBOARD]** keys or incoming MIDI notes triggering Sounds. Notes on the sequencer will not be affected. For more information, please see “10.12.6 NOTE SLIDE” on page 49.

OFF turns portamento off. No played notes will be affected.

ON turns portamento on. All played notes will be affected.

LEGATO activates portamento for overlapping notes only. LEGATO MODE needs to be activated for this setting to function.

9.10.6 VELOCITY MOD

Gives access to a menu where up to 5 PARAMETER page parameters can be assigned to the velocity parameter. Both the VEL parameter of the NOTE menu and the velocity of incoming MIDI notes sent to the Analog Four from external devices will affect the assigned parameters. Open the menu by pressing **[YES/SAVE]**. Setting up the parameters works in the same way as setting up performance macros. For more information, please see “9.3.1 PERFORMANCE SETUP” on page 27.

9.10.7 PITCH BEND

Gives access to a menu where up to 5 PARAMETER page parameters can be assigned to the MIDI pitch bend command. If MIDI pitch bend messages are sent to the Analog Four from an external device, these messages will affect the parameters assigned in this menu. Open the menu by pressing **[YES/SAVE]**. Setting up the parameters works in the same way as setting up performance macros. For more information, please see “9.3.1 PERFORMANCE SETUP” on page 27.

9.10.8 MODULATION WHEEL

Gives access to a menu where up to 5 PARAMETER page parameters can be assigned to the MIDI modulation wheel command (CC #1). Open the menu by pressing **[YES/SAVE]**. Setting up the parameters works in the same way as setting up performance macros. For more information, please see “9.3.1 PERFORMANCE SETUP” on page 27.

9.10.9 BREATH CONTROLLER

Gives access to a menu where up to 5 PARAMETER page parameters can be assigned to the MIDI breath controller command (CC #2). Open the menu by pressing **[YES/SAVE]**. Setting up the parameters works in the same way as setting up performance macros. For more information, please see “9.3.1 PERFORMANCE SETUP” on page 27.

9.10.10 AFTERTOUCH

Gives access to a menu where up to 5 PARAMETER page parameters can be assigned to the MIDI after touch command. Open the menu by pressing **[YES/SAVE]**. Setting up the parameters works in the same way as setting up performance macros. For more information, please see “9.3.1 PERFORMANCE SETUP” on page 27.

9.11 PLAYING A SOUND

Playing a Sound is done by using the **[KEYBOARD]** keys. Select the Sound that will be played by pressing **[TRACK 1–4]** keys. The information in the LCD showing which kit is loaded will briefly change to reflect the name of the loaded Sound.

The [KEYBOARD] key range spans one octave and one note. The first and last [KEYBOARD] keys play by default a C note. To change octaves, press the [UP] and [DOWN] arrow keys. The <OCTAVE> LEDs indicate which octave is selected. The octave range possible to select ranges from -5 to 5. Please note it is not possible to change octaves if a menu utilizing the [ARROW] keys is open.

Sounds can be played back in portamento or legato modes. Settings controlling this are found in the SOUND menu. For more information, please see “9.5 SOUND MENU” on page 32.



When selecting the FX track, the <TRACK LED> of the previously active track will become half-bright. This indicates that the [KEYBOARD] keys still trig notes on this track. This allows hearing how effect parameter changes will affect the previously active track. Press [TRACK 5] key again to make the FX track fully active. The [KEYBOARD] keys will then control the FX track.

9.11.1 PLAYING A SOUND WITH A MIDI KEYBOARD

The synth voices are also possible to play with an external MIDI keyboard connected to the Analog Four. Which MIDI tracks the voices respond are set up in the MIDI CHANNELS menu. For more information, please see “12.5.3 CHANNELS” on page 58.

9.12 EDITING A SOUND

To edit a Sound, first, select one of the synth tracks by pressing [TRACK] keys 1-4. The Sound of the active synth track is the one that is edited.

The overall volume level of the active track is adjusted with the *LEVEL* knob. In the PERFORMANCE MIXER menu, all track levels are visible at the same time and can be edited using the *DATA ENTRY* knobs. For more information, please see “9.3.5 PERFORMANCE MIXER” on page 28.

Sounds are edited by adjusting the parameters found on the synth track PARAMETER pages. Access these pages by pressing the [PARAMETER] page keys. If a page contains a subpage, press the [PARAMETER] page key again to access it. Use the *DATA ENTRY* knobs to change the parameters.

Six different PARAMETER pages exist. For more information, please see “APPENDIX A: SYNTH TRACK PARAMETERS” on page 83.

OSC1 controls oscillator 1. Contains one sub page for the noise generator.

OSC2 controls oscillator 2. The sub page hosts parameters relevant for both oscillators.

FILTERS controls the two filters and the overdrive. One 24 dB/octave 4-pole lowpass ladder filter and one 2-pole multimode filter are available, connected in series with the overdrive between them.

AMP contains parameters for the amplitude envelope and the effect sends. .

ENV offers two freely assignable envelopes. The first one also controls the filters. The second envelope is located in a subpage.

LFO is where parameters for the two freely assignable LFOs are found. Contains one subpage.

9.13 EDITING THE FX AND CV TRACKS

Editing the FX and CV tracks is very similar to editing the Sounds of the synth tracks. The PARAMETER pages contain parameters relevant for the two types of tracks. For more information, please see “APPENDIX B: FX TRACK PARAMETERS” on page 89. For more information, please see “APPENDIX C: CV TRACK PARAMETERS” on page 94.



FX and CV track parameter settings are only saved as part of a kit.

9.13.1 THE FX TRACK

The FX track controls the Analog Four internal send effects. To edit the FX track, press the [TRACK] key 5. Five PARAMETER pages exist for the FX track:

EXT IN contains parameters relating to the external inputs.

CHORUS controls the Wideshift Chorus effect.

DELAY controls the Saturator Delay effect.

REVERB controls the Supervoid Reverb effect.

LFO contains parameters for the two LFOs that can modulate the FX track parameters.

9.13.2 THE CV TRACK

The CV track is used for controlling external equipment capable of receiving CV/Gate signals. To edit the CV track, press **[TRACK]** key 6. A CV track contains six **PARAMETER** pages:

CV A controls the signal sent from the CV A output.

CV B controls the signal sent from the CV B output.

CV C controls the signal sent from the CV C output.

CV D controls the signal sent from the CV D output.

ENV offers two freely assignable envelopes for control of the CV track parameters.

LFO offers two freely assignable LFOs which can be used to control the CV track parameters.

9.14 TRACK MUTING

Mute tracks by pressing **[FUNCTION]** + the **[TRACK]** key of the track you want to mute. Only the note trigs of the sequencer are muted, meaning it is still possible to play a muted track manually using the **[KEYBOARD]** keys. When changing patterns, the same track mutes will be present in the next pattern as well.

The **<TRACK>** LEDs indicate the mute status. Unlit **<TRACK>** LEDs indicate the muted tracks. Green **<TRACK>** LEDs indicate audible tracks. A red **<TRACK>** LED indicates the active, audible track. A yellow **<TRACK>** LED indicates an active, muted track.



Track muting can also be done while in **PERFORMANCE** mode. For more information, please see “9.3.4 **PERFORMANCE MUTE**” on page 28.

Tracks can also be muted in **SONG** and **CHAIN** mode. This sort of muting, called song muting, works differently compared to track muting, most notably because song mutes are pattern exclusive. See page 45 for more info. For more information, please see “11.2.3 **ADDING REPEATS, MUTES AND TRANSPOSE INFORMATION**” on page 54.

10. THE SEQUENCER

The sequencer of the Analog Four stores information in patterns. A pattern controls the playback of the synth, FX and CV tracks and various aspects of these tracks. Each of the 8 banks, ranging from A to H, hosts 16 patterns, meaning that 128 patterns are available. All adjustments made to the patterns are automatically saved. Changes made to the active pattern can, however, be reverted. For more information, please see “10.5 PATTERN MENU” on page 42.



All sequencer tracks on the Analog Four can also be set to send sequencer data through the MIDI OUT or USB ports to control external, MIDI equipped, gear. Each track sends note on/off and velocity data over MIDI. For more information, please see “10.9.6 SEND MIDI” on page 45.

A PATTERN CONTAINS:

- Note trigs for all tracks.
- Trigless locks for all tracks.
- Parameter locks.
- Trig mutes.
- Accent trigs.
- Note and parameter slide trigs.
- Swing trigs.
- ARP and NOTE menu parameter settings.
- Information about which kit is linked to the pattern.
- Length and time signature for the tracks.

10.1 BASIC PATTERN OPERATIONS

The Analog Four can seamlessly switch between patterns. This, plus the ability to chain patterns, are handy features when for example making live improvisations.

10.1.1 SELECTING A PATTERN

Press the **[BANK GROUP]** key to choose the bank group from which a pattern will be selected. If for example bank group A-D is chosen, patterns in banks A, B, C and D can be selected. Next, press a **[BANK]** key followed by a **[TRIG]** key to select a pattern within the selected bank. To select for example pattern B05, select bank group A-D using the **[BANK GROUP]** key. Then press and hold **[BANK B/F]** and press **[TRIG 5]** key.

Patterns containing data are indicated by half-bright red <TRIG> LEDs. The currently active pattern is indicated by a full-bright red <TRIG> LED.

When you select an empty pattern, the kit of the previous pattern will be preliminarily selected, and the kit number will start flashing on the LCD screen (to draw attention to the fact that the kit is not yet decisively linked to the new pattern). Load another kit, if you wish, at this point. When you start editing the pattern or save the kit, the kit will be linked to the pattern, and the kit number will stop flashing on the LCD screen.

When a pattern is playing, and a new pattern is selected, the new pattern position will be shown flashing in the lower left corner of the LCD screen (If default, SEQUENTIAL, pattern mode is active). Once the last step of the pattern has played, the new pattern will start and the pattern position will cease to flash.



Pattern selection can be made using only one hand. After a **[BANK]** key has been pressed, a window will appear for a short while, stating “CHOOSE PTN”. If a **[TRIG]** key is pressed while this window is visible, a pattern will be selected.

Patterns can be changed while the sequencer is running.

Patterns can be changed and queued by sending program change messages.

After having selected a pattern, and before releasing any key, **[RECORD]**, **[PLAY]** and **[STOP]** can be pressed to copy, clear or paste patterns. No new chain will be built, nor any pattern enqueued. It is possible to clear, copy or paste multiple patterns at the same time.

10.1.2 PATTERN CONTROL

Pressing **[PLAY]** will start the playback of a pattern. Pressing **[STOP]** will stop the playback of all tracks. The sound will be cut off, but effects like the Saturator Delay will continue to be audible until the delay

repeats have faded out. When the sequencer is stopped, quickly pressing **[STOP]** + **[STOP]** will stop playback of all tracks and fade out the send effects. This also sends out an All Sound Off message over MIDI.

When a pattern is playing and **[PLAY]** is pressed the playback will be paused. Press **[PLAY]** again to resume the playback.

If a pattern contains more than 16 sequencer steps, the <PATTERN PAGE> LEDs will indicate this. When a pattern is playing, the currently active pattern page is indicated by a blinking, full-bright, <PATTERN PAGE> LED.

10.1.3 TEMPO

Press **[TEMPO]** to open the TEMPO screen where you can set the overall BPM speed.



Use the *LEVEL* knob to change the tempo setting. The **[UP]** and **[DOWN]** key changes the decimal part of the tempo.



Note that you can choose between a project tempo (same tempo for all the patterns in a project) or use a separate tempo for every pattern. Press **[FUNCTION] + **[YES]** to switch between PROJECT and PATTERN tempo mode.**

To tap a tempo setting, hold the **[FUNCTION]** key and tap the **[TEMPO]** key in a steady rhythm. After four consecutive taps, the average tempo of the taps will be calculated. By continuing tapping, the average tempo will keep on updating.

The tempo can temporarily be shifted up or down by 10% by pressing the **[LEFT]** or **[RIGHT]** arrow keys. When the key is released, the BPM will revert back to the original setting.

When in the TEMPO menu, holding **[FUNCTION]** while turning the *TRACK LEVEL* knob will not change the tempo to the selected value until the **[FUNCTION]** key is released. “PREP” is shown in the lower left corner of the screen. This functionality is only available in PROJECT tempo mode.

Tempo shift is very handy when manually syncing the Analog Four to a turntable or an external sound source. Note that you do not need to be in the TEMPO menu to perform tempo shifting.

10.2 PATTERN MODES

When changing patterns, different modes affecting the way the active pattern will be changed exist. Toggle between the PATTERN modes by pressing **[FUNCTION]** + **[BANK GROUP]**. The <PATTERN MODE> LED indicates which mode is selected. Three PATTERN modes exist.

DIRECT START will immediately change patterns. The new pattern will start playing from the beginning. This mode is indicated by a red <PATTERN MODE> LED.

DIRECT JUMP will immediately change patterns. The new pattern will start playing from the position where the previous pattern left off. This mode is indicated by a green <PATTERN MODE> LED.

SEQUENTIAL will change patterns after the currently playing pattern reaches its end. This mode is the default mode. It is indicated by an unlit <PATTERN MODE> LED.

10.3 EDITING A PATTERN

The Analog Four offers three modes of inputting trigs when editing or creating a pattern, GRID RECORDING mode, LIVE RECORDING mode, and STEP RECORDING mode. In these modes, two types of trigs can be entered: note trigs and trigless locks.

10.3.1 TRIG TYPES

Two types of trigs exist, note trigs and trigless locks. Note trigs trig notes while trigless locks can be used to apply parameter locks without triggering notes. Note trigs are indicated by full-bright <TRIG> LEDs and trigless locks are indicated by half-bright <TRIG> LEDs. For more information, please see “10.12.1 PARAMETER LOCKS” on page 47. The two types of trigs are entered differently depending on whether GRID or LIVE recording mode is active.

10.3.2 GRID RECORDING MODE

GRID RECORDING is a method of composing where trigs are added by using the **[TRIG]** keys.

Enter GRID RECORDING mode by pressing the **[RECORD]** key. A lit red <REC> LED indicates GRID RECORDING mode is active. Select the track to which you want to add trigs by pressing the relevant **[TRACK]** button. Place note trigs on the sequencer by pressing the **[TRIG]** keys. To add note values to trigs of the synth tracks, press and hold a **[TRIG]** key while pressing a **[KEYBOARD]** key. To add a trigless lock, press **[FUNCTION]** and **[TRIG]**. Add micro timing to a note trig by pressing and holding the **[TRIG]** key while pressing **[LEFT]** or **[RIGHT]**. A micro timing pop up menu will appear, showing the note offset.

If the pattern contains more than 16 steps, switch to the pattern page you want to edit by pressing the **[PAGE]** key. The active pattern page is being indicated by a fully lit <PATTERN PAGE> LED.

Press **[PLAY]** to listen to the sequence.



- Press **[TRIG]** + **[YES/SAVE]** to preview a specific trig. The preview includes any parameter locks you have placed on that trig.
- All trigs of a track can be shifted forward or backward on the sequencer. While in GRID RECORDING mode, hold down **[FUNCTION]** while pressing the **[LEFT]** or **[RIGHT]** arrow keys to perform the trig shift.

10.3.3 LIVE RECORDING MODE

LIVE RECORDING mode is the second method of adding trigs to the tracks. In this recording mode, the **[KEYBOARD]** keys, or an external MIDI keyboard connected to the Analog Four, can be played in real time to input trigs to the tracks. It is also possible to enter parameter locks in real time. Trigs input in LIVE RECORDING mode will be placed on the sequencer in a micro timed fashion, meaning the μTM parameter in the NOTES SETUP menu will be locked accordingly to more accurately reflect the input timing of the trigs. This makes LIVE RECORDING mode record note inputs in a more expressive and un-quantized way. Micro timed trigs can be quantized, which is done in the NOTES SETUP menu. For more information, please see “10.4.1 NOTES SETUP” on page 41. For more information, please see “10.8 NOTE MENU” on page 44.

Hold **[RECORD]** and press **[PLAY]** to enter LIVE RECORDING mode. The sequencer will start to play, and the <RECORD> LED will start to flash. You can now enter trigs to the active track in real time by pressing the keys on the KEYBOARD. For the synth and CV tracks, note values according to the KEYBOARD key presses will be recorded. To activate quantization of the LIVE RECORDING, do as above but double-press **[PLAY]**.

To real time erase all trigs from a track, press and hold **[TRACK]** + **[NO/RELOAD]**. All trigs hit by the running LED of the sequencer will be erased from the active track. The trigs of more than one track can be removed by pressing several **[TRACK]** keys simultaneously.

To stop both the recording and the playback of the sequencer, press **[STOP]**. To exit LIVE RECORDING mode while keeping the sequencer playing, press **[PLAY]**. If LIVE RECORDING mode is active and **[RECORD]** is pressed, GRID RECORDING mode will be entered.

10.3.4 STEP RECORDING MODE

STEP RECORDING is a quick and straightforward method of placing trigs on the sequencer. In this recording mode, you insert notes by pressing the **[KEYBOARD]** keys or using an external MIDI controller. The sequencer then captures the note and automatically advances to the next step. There are two different modes available, STANDARD mode and JUMP mode.

STANDARD mode

1. Press **[TRACK 1–4, FX, CV]** to select the track to which you want to add trigs. A green LED next to the **[TRACK]** key indicates the active track.
2. Press **[RECORD]** + **[STOP]** to enter STEP RECORDING mode. The **[RECORD]** key starts to double-blink red. (Press **[STOP]** twice while keeping the **[RECORD]** key pressed to toggle between STANDARD and JUMP mode).
3. Press a **[TRIG]** key to select the active step to where you want to start to add note trigs. The active step is shown with a **[TRIG]** key that double-blinks. You can also use **[LEFT]/[RIGHT]** to select the active step or skip steps.
4. Press the **[KEYBOARD]** keys or use an external MIDI controller to add a note trigs to the selected step. The active step then automatically advances to the next step. You can use **[UP]/[DOWN]** to transpose the **[KEYBOARD]** keys up or down one octave. To play a track polyphonically, the track must be configured to use several voices. For more information, please see “9.4.1 POLYPHONY CONFIGURATION” on page 28.

5. To remove a trig or to add a rest (no trig), position the active step on the trig that you want to remove or add a rest to, and then press **[NO/RELOAD]**. The active step then automatically advances to the next step.
6. To add a parameter lock to a trig, press and hold a **[TRIG]** key, and then turn the **DATA ENTRY** knob that controls the parameter you want to lock and set it to the desired value. The graphics become inverted for the locked parameter, and the locked parameter value is displayed. The **[TRIG]** key of the locked trig blinks red (for note trigs) or yellow (for lock trigs) to indicate that the trig now contains a parameter lock.
7. Press **[RECORD]** to exit STEP RECORDING mode.

JUMP mode

In JUMP mode, the **LEN** parameter setting in the NOTE menu controls the note length of the trigs you place, and advances the active step the same length. A **LEN** value of 1/16 adds a sixteenth note and advances the sequencer one step. 1/8 adds an eighth note and advances the sequencer two steps. 1/4 adds a quarter note and advances the sequencer four steps and so on. The **LEN** parameter is also parameter locked on every trig placed.



- Press **[TRIG]** + **[YES/SAVE]** to preview a specific trig. The preview includes any parameter locks you have placed on that trig.
- Press **[PLAY]** to listen to the sequence while you are programming it. Press **[STOP]** to stop the sequencer and stay in STEP RECORDING mode.
- Press and hold a **[KEYBOARD]** key, and then press another **[KEYBOARD]** key to add multiple notes (a chord) on the same sequencer step. To achieve this, the track must be configured to use several voices. For more information, please see “9.5.1 POLYPHONY CONFIGURATION” on page 28.
- If you use an external MIDI controller, you must set it to send MIDI data on the Analog Four’s defined AUTO CHANNEL. “12.5.3 CHANNELS” on page 58.
- If you use an external MIDI controller, the trig’s **VEL** (velocity) value is determined by the velocity sent from these and is parameter locked.
- If you press and hold **[FUNC]** while inputting notes from an external MIDI controller, the velocity is fixed and determined by the **VEL** parameter setting.
- If you press and hold **[YES/SAVE]** while you place a trig with **[KEYBOARD]** keys or an external MIDI controller, the trig length is locked to the time you press the **[KEYBOARD]** keys or the external MIDI controller.
- If you add a new note trig on a previously placed note trig, any parameter locks previously placed on that trig remain as they were.

10.4 TRACK MENU

In this menu settings and options related to the active track are found. Open the menu by pressing **[FUNCTION]** + **[KEYBOARD E1]**. Navigate in the list using the **[UP]/[DOWN]** arrow keys or the **LEVEL** knob. Select options by pressing **[YES]**. Change the track that the menu will affect by pressing the **[TRACK]** keys.

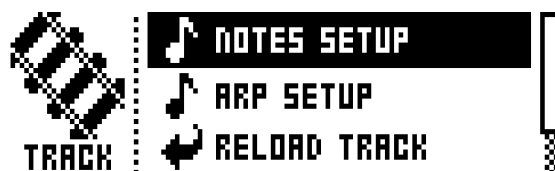

10.4.1 NOTES SETUP

Contains settings mainly relating to track quantization and scale. It is the same menu as accessed by pressing **[FUNCTION]** + **[NOTE]**. For more information, please see “10.9 NOTES SETUP” on page 45.

10.4.2 ARP SETUP

Contains settings for the track arpeggiators. It is the same menu as accessed by pressing **[FUNCTION]** + **[ARP]**. For more information, please see “10.7 ARPEGGIATOR SETUP” on page 43.

10.4.3 RELOAD TRACK

Reloads the active track. Since tracks are a part of patterns which are automatically saved, it will either

be reloaded to its auto-saved state or a specific saved state set by the SAVE TRACK command. Remember that when you change pattern the track settings are saved automatically and will then overwrite the SAVE TRACK saved state. Press [NO/RELOAD] + [KEYBOARD E1] for a shortcut to the RELOAD TRACK command.

10.4.4 SAVE TRACK

Saves changes made to the active track. This is a special feature available in addition to the general, automatic, saving of patterns which occur when patterns are changed. The feature is useful in situations where an individual track is being worked on, the results are favorable and you want to keep on working with the track while having the ability to revert it to a specific saved state. The SAVE TRACK command makes this possible. When reloading the track, it will not be reloaded to its original, pattern auto-saved, state, but to the manually saved state. Press [YES/SAVE] + [KEYBOARD E1] for a short cut to the SAVE TRACK command.

10.5 PATTERN MENU

In the PATTERN menu patterns can be saved and reloaded. Open the menu by pressing [FUNCTION] + [KEYBOARD F1]. Select between the available commands by using the [UP]/[DOWN] arrow keys. Confirm selections with [YES/SAVE].



10.5.1 RELOAD PATTERN

Reload the active pattern. It will either be reloaded to its auto-saved state or a specific saved state set by the SAVE PATTERN command. Press [NO/RELOAD] + [KEYBOARD F1] for a short cut to the RELOAD PATTERN command.

10.5.2 SAVE PATTERN

Saves changes made to the active pattern. This is a special feature available in addition to the general, automatic, saving of patterns which occurs when patterns are changed. The feature is useful in situations where a pattern is being worked on, the results are favorable, and you want to keep on working with the pattern while having the ability to revert to a specific saved state. The SAVE PATTERN command makes this possible. When reloading the pattern, it will not be reloaded to its original, auto-saved, state, but to the manually saved state. Press [YES/SAVE] + [KEYBOARD F1] for a short cut to the SAVE PATTERN command.



The RELOAD PATTERN command is great when improvising live. Any changes made to the active pattern, like adding bass line notes or similar, can immediately be undone.

10.6 ARPEGGIATOR

The ARPEGGIATOR menu controls the six arpeggiators, one for each track. Arpeggiator settings are a part of the pattern, and they are not stored together with kits. Select the track whose arpeggiator will be edited by pressing the relevant [TRACK] key. Open the ARPEGGIATOR menu by pressing [ARP].

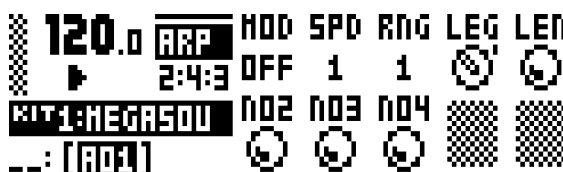

10.6.1 MOD

Activates the arpeggiator and controls how the arpeggiated notes will be sorted.

OFF will deactivate the arpeggiator.

THR will play the notes in the same order as they were inserted.

UP will play the notes in ascending order, from the lowest note to the highest, on a per octave basis.

DWN will play the notes in descending order, from the highest note to the lowest, on a per octave basis.

CYC will play the notes first in ascending order, then in descending order.

SHF will play the notes randomly on an octave range basis. If the arpeggio, for example, has an RNG setting of 2, the notes of the first octave range will be played randomly and once all notes have been played, all the notes of the second octave will be played in a new random order.

RND will randomize the playback of the arpeggiated notes.

PLY will arpeggiate a complete chord (POLYPHONY must be activated, see page 19) in the same way an individual note is arpeggiated in TRU mode.

10.6.2 SPD

Sets the speed of the arpeggiator. It is synchronized to the BPM of the project. A setting of 6 equals 16th notes, a setting of 12 equals 8th notes and so on.

10.6.3 RNG

Sets the octave range of the arpeggiator. After each finished arpeggiator cycle, the arpeggiated notes will be transposed one octave up. When the notes have reached the octave offset specified by the **RNG** setting the notes will be reset to their initial values. From there the octave transpose will be started all over again.

10.6.4 LEG

Controls the legato of the arpeggiator. This setting will affect the note trigs of the track even if the MOD setting is set to OFF.

ON will play overlapping notes legato, releasing the old note after the new one. The **LEN** parameter adjusts the length of the notes when the arpeggiator is activated. If the arpeggiator is not activated, then the **LEN** parameter on the NOTE menu will adjust the length of the notes. For more information, please see "10.8.3 LEN" on page 44.

OFF will send out a MIDI note off message before the start of each arpeggiated note.

10.6.5 LEN

Controls the length of the arpeggiated notes.

10.6.6 NO2-NO4

Selects the offset in semi-tones for three additional arpeggio notes. The offset is made from the original note trig. The TRK KEY SCALE and TRK KEY NOTE settings found in the NOTES SETUP menu will affect the note values of the arpeggiated notes.



Please note only the NO2-NO4 parameters can be parameter locked.

10.7 ARPEGGIATOR SETUP

Pressing [FUNCTION] + [ARP] opens the ARPEGGIATOR SETUP menu. Here the arpeggiator length and note offsets are set.



Select the length of the arpeggio by turning **DATA ENTRY** knob **E**. The max length is 16 sequencer steps. The <TRIG LEDS> indicate the length of the arpeggio and, when the arpeggio is playing, the number of played arpeggio notes.

Arpeggio note offsets can be inserted by pressing a [TRIG] key and turning **DATA ENTRY** knob **J**. By pressing several [TRIG] keys simultaneously it is possible to adjust the note offsets of more than one step.

10.8 NOTE MENU

The NOTE menu controls general note settings for the active track. Open by pressing [NOTE]. NOTE menu settings are a part of the pattern, and they are not stored together with kits.



The parameter settings seen in the NOTE menu settings are the default settings when placing trigs on the sequencer. Entering three note trigs, changing, for example, the note length parameter and then entering three more note trigs will thus make the last three note trigs share a different note length compared to the first three. To add individual settings per note, utilize parameter locks. For more information, please see “10.12.1 PARAMETER LOCKS” on page 47. μ TM, ENV, and LFO settings can only be changed when parameter locked.

10.8.1 NOT

Sets the default note value.

10.8.2 VEL

Sets the velocity value. The higher the value, the higher the volume of the note. The default value is 100. Please note that this value will affect any VELOCITY MOD menu assignments. For more information, please see “9.10.6 VELOCITY MOD” on page 35.

10.8.3 LEN

Sets the note length.

10.8.4 μ TM

Controls the micro timing offset. A negative value will nudge the trig to a position before the quantized sequencer step, a positive after. Each micro timing value step is equal to one 1/384th of a note. When entering note trigs in the LIVE RECORDING mode, they will automatically be micro timed. For more information, please see “10.3.3 LIVE RECORDING MODE” on page 40.

10.8.5 PRB

Trig Probability sets the probability that the trigs on the track plays or not. The probability outcome is re-evaluated every time a trig is set to play. The default setting is 100%, meaning that all the trigs on the track plays every time. (0%–100%)

This parameter changes temporarily to display and control TRC (Trig Condition) when you add a conditional lock. TRC sets the Trig Condition with which a set of conditional rules can be applied to any trig, using a parameter lock. For more information, please see “10.12.3 CONDITIONAL LOCKS” on page 48.



If you have placed a conditional lock on a trig in the sequencer, the trig condition overrides the Trig Probability setting. For example, if you set PRB to 70% and a FILL trig condition on a trig, that trig will only (and always) play when the sequencer is in FILL mode. For more information, please see “10.12.3 CONDITIONAL LOCKS” on page 48.

10.8.6 ENV (F)

Controls whether the ENVF should be retrigged or not when a note trig or trigless lock is activated by the sequencer.

10.8.7 ENV (2)

Controls whether the ENV2 should be retrigged or not when a note trig or trigless lock is activated by the sequencer.

10.8.8 LFO (1)

Controls whether the LFO1 should be retrigged or not when a note trig or trigless lock is activated by the sequencer.

10.8.9 LFO (2)

Controls whether the LFO2 should be retrigged or not when a note trig or trigless lock is activated by the sequencer.



It is possible to real time record and real time erase NOT, VEL and LEN parameters. This is useful when for example inputting notes using an external MIDI keyboard sending MIDI velocity data. The same applies when entering notes using the mini-keyboard. In this case VEL changes will not be recorded though, as the mini-keyboard is not velocity sensitive. For more information, please see “10.12.1 PARAMETER LOCKS” on page 47.

When real time erasing all locks by pressing [FUNCTION]+[NO/RELOAD], note parameters are not included.

10.9 NOTES SETUP

In the NOTES SETUP menu, more settings relating to notes of the active track are found. Access the menu by pressing [FUNCTION] + [NOTE]. Navigate in the menu using the [UP]/[DOWN] arrow keys or the *LEVEL* knob. Change settings with the [LEFT]/[RIGHT] arrow keys.

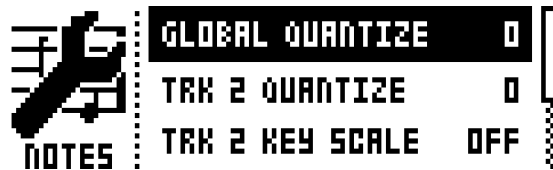

10.9.1 GLOBAL QUANTIZE

Affects all micro timed trigs of all tracks. The higher the quantize value, the more all micro timed trigs will be quantized.

10.9.2 TRK QUANTIZE

Affects all micro timed trigs of the active track. The higher the quantize value, the more all micro timed trigs will be quantized.

10.9.3 TRK KEY SCALE

Sets the key scale of the track. All notes on the sequencer track will be auto-adjusted to the selected scale. The setting is non-destructive, meaning if the setting is changed from for example MIN to OFF, the notes will start playing according to their original note values. This setting also affects how the track will be transposed when performing a transpose function. If for example MAJ is set, all notes of the track will be transposed according to a major scale. For more information, please see “10.12.9 TRACK TRANSPOSE” on page 50.

10.9.4 TRK KEY NOTE

Sets the key note of the track. This setting affects how the track will be transposed when performing a transpose function. The transpose will be an offset from the key note.

10.9.5 TRK TRANSPOSABLE

Will when activated make the track transposable. If deactivated, the track can not be transposed, which can be a relevant setting for tracks containing drum sounds. A quick command for this setting exists. Press [TRANSPPOSE] + [TRACK] to activate/deactivate the transpose functionality for a track. For more information, please see “10.12.9 TRACK TRANSPOSE” on page 50.

10.9.6 SEND MIDI

Will, when checked, send the tracks note on/off (NOTE, LEN) and VELOCITY, sequencer data to the Analog Four’s MIDI OUT for control of external MIDI devices. The MIDI data is sent on the track’s MIDI channel that is set in the CHANNELS menu. For more information, please see “12.5.3 CHANNELS” on page 58.

10.10 CLICK TRACK

The CLICK TRACK menu controls the internal metronome of the Analog Four. Open the menu by pressing [FUNCTION] + [KEYBOARD A1]. Use the [UP]/[DOWN] arrow keys or the *LEVEL* knob to select in the list of settings. Press [LEFT]/[RIGHT] to change the highlighted setting.

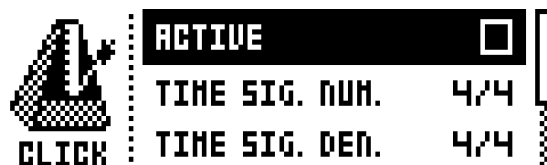

10.10.1 ACTIVE

Activates/deactivates the metronome. It is also possible, outside of this menu, to keep [FUNCTION] + [KEYBOARD A1] pressed for a second to toggle the click on or off.

10.10.2 TIME SIG. NUM

Controls the note measure of the metronome time signature.

10.10.3 TIME SIG. DEN

Controls the beat measure of the metronome time signature.

10.10.4 PREROLL

Controls for how many bars the metronome will sound before the sequencer starts playing. This setting is only relevant when LIVE RECORDING mode is initiated.

10.10.5 VOLUME

Controls the volume of the click.

10.11 SCALE MENU

Here the general length and timing of the active pattern are set. Two modes exist in the SCALE menu. In NORMAL mode all tracks share the same length. In ADVANCED mode each track can have different lengths. Access the SCALE SETUP menu by pressing [FUNCTION] + [PAGE]. Use the [LEFT] and [RIGHT] arrow keys to select between the available settings. Use the [UP] and [DOWN] keys to adjust the different settings and to select between the two modes. The *LEVEL* knob can be used to adjust settings as well.

10.11.1 NORMAL MODE

This is the default mode. In this mode, all tracks of the pattern share the same length. This screen will appear when the NORMAL setting is active.



The first two settings control the step length of the pattern. The leftmost number selects the number of steps in the pattern. The maximum number of steps available to the pattern is determined by the total length, set by the parameter to the right. This can be either 16, 32, 48 or 64 steps. If 17 steps or more are used in a pattern, the [PAGE] key is, while in GRID RECORDING mode, used to toggle between the different pattern pages.

The rightmost parameter controls the scale (The speed of pattern playback in multiples of the current tempo). It offers seven possible settings, 1/8X, 1/4X, 1/2X, 3/4X, 1X, 3/2X and 2X. A setting of 1/8X will play back the pattern at one-eighth of the set tempo. 3/4X plays the pattern back at three-quarters of the tempo. 3/2X will play back the pattern twice as fast as the 3/4X setting. 2X will make the pattern play at twice the BPM.



Trigs are automatically copied when extending the length of a pattern. If a pattern consists of for example two pages and the pattern length is increased to four pages, and the two added pattern pages will be copies of the first two pattern pages.

Press the [PAGE] key for quickly changing the total length of the pattern. Press the [TRIG] keys to quickly change the number of steps of the pattern.

A 2X time signature setting is useful for increasing the base resolution of the step sequencer to 32nd notes. A 3/4X setting is useful when the Analog Four is playing alongside other instruments set to the same BPM, and you want the Analog Four to play triplets.

10.11.2 ADVANCED MODE

In this mode, the tracks of the pattern can be assigned individual lengths and scale. Select ADVANCED mode by navigating to the SCALE column using the [LEFT] arrow key. Select **ADVANCED** by using the [DOWN] arrow key. In ADVANCED mode, two columns exist, TRACK and MASTER.

MODE	TRACK 1	MASTER		
NORM.		LEN	CHNG	
ADV.	16/16 1*	16	16	1*
			—	

The TRACK column sets the step length and time signature scale of the track. It works just like setting the pattern length and scale in NORMAL mode. The settings will only affect the active track. Press the [TRACK] keys to select the track whose settings will be edited.

The MASTER column is only available in ADVANCED mode. Here the master length, the master change length of the pattern are set.

LEN controls the number of steps the pattern will play before all tracks are restarted. An INF setting will make the tracks of the pattern loop infinitely, without ever being restarted. Note that this setting also affects for how long the active pattern will play before a chained pattern will start playing. This can be overridden by the CHNG parameter.

CHNG controls for how long the active pattern will play before a cued or chained pattern will begin to play. This setting is important when for example LEN is set to INF. If no CHNG setting is made, the pattern will play infinitely, and the next pattern will thus not be cued. But if CHNG, for instance, is set to 64, the pattern will behave like a pattern consisting of 64 steps regarding cuing and chaining.

MASTER SCALE is the rightmost setting. It sets the general time signature of the pattern.



If INF is selected, the active pattern will play infinitely, making it impossible to change to another pattern.



Press [FUNCTION] + [UP]/[DOWN] to set the lengths in increments of 16.

10.12 SEQUENCER FEATURES

10.12.1 PARAMETER LOCKS

Parameter locks is a powerful feature that allows trigs to have their own unique parameter values. The note trigs of a synth track could, for example, have different pitch or filter settings. All parameters found on the PARAMETER pages and NOTE menus are possible to parameter lock. (On the ARP page you can parameter lock the note offset values.) Parameter locks can be applied to all types of tracks. Parameter locks can be removed by either performing a clear locks command or by removing the trig and entering it again. For more information, please see “10.12.11 COPY, PASTE, AND CLEAR OPERATIONS” on page 51.

To apply parameter locks in GRID RECORDING mode, press and hold the [TRIG] key of a trig. Adjust the parameters you want to lock using the *DATA ENTRY* knobs. The graphics in LCD will become inverted for the locked parameter, and the locked parameter value will be displayed. The <TRIG> LED of the locked trig will begin to flash rapidly, indicating the trig now contains a parameter lock. Remove a single parameter lock by holding [TRIG] + pressing the *DATA ENTRY* knob of the locked parameter. By removing a note trig and entering it again, all parameter locks will be erased from the trig.

In LIVE RECORDING mode, turning a *DATA ENTRY* knob will input parameter locks to the active track. Note trigs will be locked accordingly, and trigless locks containing the parameter locks will be placed on the sequencer steps that do not have note trigs.

To remove the parameter locks on the active track while LIVE RECORDING mode is active, press and hold [FUNCTION] + [NO/RELOAD]. Sound locks will however not be erased. Remove specific parameter locks in real time by pressing [NO/RELOAD] while pressing the *DATA ENTRY* knob corresponding to the parameter that will be removed.



Up to 128 different parameters can be locked in a pattern. A parameter counts as one (1) locked parameter no matter how many trigs that lock it. If for example the cutoff parameter of the ladder filter of synth track 1 is locked on every sequencer step, there are still 127 other parameters that can be locked.

10.12.2 SOUND LOCKS

All Sounds residing in the Sound pool of the active project can be changed per sequencer step, which is an immensely useful feature for adding variations to a track. Press and hold a note trig and turn the **LEVEL** knob. The Sound pool list will appear. Scroll the list using the **LEVEL** knob, select the Sound you want to assign to the note trig and then release the **[TRIG]** key. The <TRIG> LED will start to flash. Pressing and holding the **[TRIG]** key of the note trig will show the assigned Sound.



The first position in the Sound pool list, titled **TRACK SOUND**, is the default selection. It will play the track Sound belonging to the active kit.

10.12.3 CONDITIONAL LOCKS

In the NOTE menu, there is a parameter called **TRC** with which a set of conditional rules can be applied to any trig, using a parameter lock. Each setting is a logical condition that will determine whether a trig set in the sequencer is triggered or not. If the condition is true then the trig will become active and affect the sequence. You must first place a trig to where you want to apply a conditional lock

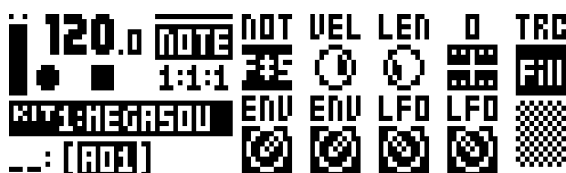

The sequencer needs to be in FILL mode to activate the parameter locks called FILL (see below). FILL mode is activated, for one pattern cycle, by pressing **[YES]** + **[PAGE]**. It will become active when the pattern loops, and remain active until it loops again.

It is also possible to activate FILL mode at any time, and for any duration, by pressing the **[PAGE]** key when the pattern is playing (GRID RECORDING mode must not be active). The FILL mode will be active for as long as the key is being held down.

Press and hold **[PAGE]** + **[YES]**, and then release **[PAGE]** before you release **[YES]** to latch FILL mode. Press **[PAGE]** again to unlatch FILL mode.

The following conditional rules may be set using the **TRC** parameter, **DATA ENTRY** knob E (in the NOTE menu) when a parameter lock is applied to a trig:

FILL is true (will activate the trig) when fill mode is active (see below).

$\overline{\text{FILL}}$ is true when FILL is not.

PRE is true if the most recently evaluated trig condition on the same track was true.

$\overline{\text{PRE}}$ is true when PRE is not.

NEI is true if the most recently evaluated trig condition on the neighbor track was true. The neighbor track is the track before the one being edited. For example, the neighbor track of track 4 is track 3. If no conditions exist on the neighbor track, the condition is false, and no sound is played.

$\overline{\text{NEI}}$ is true when NEI is not.

1ST is only true the first time the pattern play (when looped).

$\overline{\text{1ST}}$ is true when 1ST is not.

X% is a probability condition. There is an x% chance of it being true.

A:B **A** sets how many times the pattern (or track, if the track length is shorter than the pattern length) plays before the trig condition is true. **B** sets how many times the pattern (or track, if the track length is shorter than the pattern length) plays before the count is reset and starts over again. This cycle then repeats until you stop the sequencer.



Conditional parameter locks are a great way to add variety to a pattern. To set up a grid of mutually exclusive or conclusive note trigs across any of the synth tracks, and throwing some probability locks in there as well (perhaps, in turn, also sporting an array of logically conditioned trigs) is a neat way to make the most minimal of compositions come alive with randomness.

Note that random or arbitrary variety, while fun and interesting, is not the only way of using conditional trigs. They may also be used, for example, to have two different melodic or percussive sequences on the same track, one of which is activated only when fill mode is active.

10.12.4 TRIG MUTE

The TRIG MUTE menu makes it possible to add mute masks on a per trig basis. Each track can have its separate trig mute trigs. Open the menu by pressing [FUNCTION] + [BANK A/E].



Select the track to which you want to add trig mute trigs by pressing the corresponding [TRACK] key. While in the TRIG MUTE menu, entered trigs will mute any trigs placed of the active track, given the trigs are located on the same sequencer steps.



Trig mutes can be quickly added to note trigs or trigless locks. Keep the note trig, or trigless lock pressed and press [BANK A/E]. A trig mute trig will automatically be placed on the same sequencer step as the note trig/trigless lock.

Press a note trig/trigless lock to quickly see if a trig mute trig is placed on the same sequencer step as the trig. If that is the case, the <BANK A/E> LED will light up.

Trig mutes are good for experimenting with the feel of tracks when playing live. The last eight steps of a bass line track could, for example, be muted to build suspense.

10.12.5 ACCENT

Adding accent trigs is useful for quickly changing the volume and filter envelope behavior, or accentuation, for chosen steps of a track. Accent level is also a modulation destination, meaning it can be affected by for example LFOs. Open the ACCENT menu by pressing [FUNCTION] + [BANK B/F].



Select the track that will be affected by pressing the corresponding [TRACK] key. Select the accent value by turning the **LEVEL** knob. The higher the value, the more accentuation will be added to accent trigs.

While the ACCENT menu is open, the sequencer will display accent trigs. Place or remove accent trigs by pressing the [TRIG] keys. If an accent trig is placed on the same sequencer step as a note trig, the note trig will be accentuated.



A note trig can be quickly accented. Keep the note trig pressed and press [BANK B/F]. An accent trig will automatically be placed on the same sequencer step as the note trig.

Press a note trig/trigless lock to quickly see if an accent trig is placed on the same sequencer step as the trig. If that is the case, the <BANK B/F> LED will light up.

10.12.6 NOTE SLIDE

The NOTE SLIDE menu makes it possible for the pitch of two separate note trigs to slide between each other. Open the menu by pressing [FUNCTION] + [BANK C/G]. When this menu is active, and [TRIG] keys are pressed, note slide trigs will be placed on the sequencer.



If a note slide trig is placed on the same step as a note trig, the pitch of the previous note trig will slide. For instance, if a track contains two note trigs and a note slide trig is placed on the same step as the second note trig, the pitch of the first note trig will slide to the pitch of the second note trig. The speed of the pitch slide is determined by the **SLI** parameter, found in the second page of the OSC2 menu. For more information, please see “APPENDIX A: SYNTH TRACK PARAMETERS” on page 83.



Note slides can be quickly added to note trigs. Keep the note trig pressed and press [BANK C/G]. A note slide trig will automatically be placed on the same sequencer step as the note trig.

Press a note trig lock to quickly see if a note slide trig is placed on the same sequencer step as the trig. If that is the case, the <BANK C/G> LED will light up.

10.12.7 PARAMETER SLIDE

The PARAMETER SLIDE menu makes it possible for the parameter values of two separate note trigs or trigless locks of a track to slide between each other. Open the menu by pressing [FUNCTION] + [BANK D/H]. When this menu is active, and [TRIG] keys are pressed, slide trigs will be placed on the sequencer.



For a parameter value to slide between two trigs, it needs to be locked on one of the trigs. A locked parameter value will slide to the unlocked value and vice versa. To make the parameter value slide, place a slide trig on the same sequencer step as the trig whose parameters you want to slide. The speed of the slide is relative to the current tempo, and the slide is completed when the next trig is reached. Several parameter values can slide at the same time.



Parameter slides can be quickly added to note trigs or trigless locks. Keep the note trig or trigless lock pressed and press [BANK D/H]. A parameter slide trig will automatically be placed on the same sequencer step as the note trig/trigless lock.

Press a note trig/trigless lock to quickly see if a parameter slide trig is placed on the same sequencer step as the trig. If that is the case, the <BANK D/H> LED will light up.

10.12.8 SWING

Sets the swing of the pattern, allowing for a different rhythmic groove. Access this menu by pressing [FUNCTION] + [KEYBOARD B1].



10.12.9 TRACK TRANSPOSE

Tracks can be transposed up or down, and the transpose function can be locked for one handed operation. The tracks that will be affected by the transpose functionality are set in the NOTES SETUP menu. Read more in section "NOTES SETUP" on page 35. A quick command for this also exists. Press [TRANSPOSE] + [TRACK] to activate or deactivate the transpose functionality for the tracks. When pressing and holding the [TRANSPOSE] key, lit <TRACK> LEDs indicate which tracks are transpose activated.

To transpose, press and hold [TRANSPOSE] and press a [KEYBOARD] key. Select a different octave range to transpose to by pressing [UP] or [DOWN]. After having performed a transpose, a little pop-up window will show how many semitones the transpose consists of.

The notes of the tracks are transposed according to the TRK KEY NOTE and TRK KEY SCALE settings, found in the NOTES SETUP menu covered on page 35. The transpose is an offset to the set key note, meaning all note trigs retain their original note values after having been transposed. If for example the key note is set to a C and [KEYBOARD F1] is pressed, the transpose activated tracks will be transposed +5 semitones.

The transpose offset can be applied permanently as well. After performing a transpose, press [TRANSPOSE] + [YES/SAVE]. The value of the transposed note trigs will be permanently altered.

If [FUNCTION] + [TRANSPOSE] is pressed, the transpose lock functionality will be activated. Transpose lock is indicated by a full-bright <TRANSPOSE> LED. When this function is activated, the [TRANSPOSE] key will act as if constantly pressed, enabling one-handed transpositions when pressing the [KEYBOARD] keys.



Please note that when transpose lock is activated, the [KEYBOARD] keys will not be able to play Sounds or set the note value of note trigs. They will only be used for transpose duties. The secondary functions of the [KEYBOARD] keys, for instance, accessing the KIT and SOUND menus, are still possible to access.

10.12.10 DESTRUCTIVE TRANSPOSE

Tracks can be transposed destructively, altering the note values of the note trigs permanently. Do so by pressing [TRACK] + [UP]/[DOWN]. The value of the note trigs will be changed up or down in the selected amount of semitones. The tracks do not have to be transpose activated for this to work.

10.12.11 COPY, PASTE, AND CLEAR OPERATIONS

Patterns, track pages, tracks, and trigs can be copied, pasted and cleared.

The active pattern can be copied to either another location in the same bank or to a location in another bank. To perform a pattern copy operation, GRID RECORDING mode must not be active. Copy the pattern by pressing [FUNCTION] + [RECORD]. Select another pattern and paste the copied pattern to this location by pressing [FUNCTION] + [STOP]. The operation can be undone by pressing [FUNCTION] + [STOP] again. Clear a pattern by pressing [FUNCTION] + [PLAY]. Undo the operation by repeating the button presses.

After having selected a pattern, and before releasing any key, [RECORD], [PLAY] and [STOP] can be pressed to copy, clear or paste patterns. No new chain will be built, nor any pattern enqueued. It is possible to clear, copy or paste multiple patterns at the same time.

Individual tracks can be copied, pasted and cleared in the same way as patterns. To do so, GRID RECORDING mode needs to be active.

A track page is one of the up to four pages of sequencer steps a pattern can consist of. It is similar to copy/paste/clear a track, but will only affect the active track page. GRID RECORDING mode needs to be active here as well. Select the track page that will be affected by pressing the [PAGE] key. Copy by pressing [PAGE] + [RECORD]. Select a new track page and press [PAGE] + [STOP] to paste. Undo by pressing [PAGE] + [STOP] again. Press [PAGE] + [PLAY] to clear the active track page. Undo the operation by repeating the button presses.

Copy the Sound of a synth track by pressing [TRACK] + [RECORD]. Select a new track to which the Sound will be pasted and press [TRACK] + [STOP] to paste.

Trigs, complete with all parameter lock settings, can be copied, pasted and cleared as well. GRID RECORDING mode needs to be active to access this functionality. Press and hold a trig and press [RECORD] to perform the copy operation. Paste by holding another [TRIG] key and pressing [STOP]. It is also possible to copy more than one trig. Press and hold the trigs you wish to copy, and then press [RECORD]. Press and hold the [TRIG] key to where you want to paste, and then press [STOP] to paste the copied sequence of trigs. When pasting, the copied trigs are placed in the same relation to each other as they had when they were copied. The destination trig acts as the starting point for the sequence of copied trigs. Clear trig locks by holding one or more trigs and press [PLAY].

10.12.12 QUICK SAVE AND RELOAD COMMANDS

Kits, Sounds, tracks, patterns, and songs can instantly be saved and reloaded. When reloading, settings will revert to their saved state.

To quick save a kit, press [YES/SAVE] + [KEYBOARD C1]. This command is the same as the SAVE KIT command found in the KIT menu. For more information, please see "9.2 KIT MENU" on page 25.

To quick save the track Sound of the active track, press [YES/SAVE] + [KEYBOARD D1]. This command is the same as the STORE TRACK SOUND command found in the SOUND MANAGER menu. For more information, please see "9.5 SOUND MENU" on page 32.

To quick save a track, press [YES/SAVE] + [KEYBOARD E1]. The operation is the same as the SAVE TRACK command. For more information, please see "10.4.4 SAVE TRACK" on page 42.

To quick save the active pattern, press [YES/SAVE] + [KEYBOARD F1]. The operation is the same as the SAVE PATTERN command. For more information, please see "10.5.2 SAVE PATTERN" on page 42.

To quick save a song, press [YES/SAVE] + [KEYBOARD G1]. The command is the same as the SAVE command found in the SONG menu. For more information, please see "11.2.4 SONG MENU" on page 55.

To quick reload a kit, press [NO/RELOAD] + [KEYBOARD C1]. This command is the same as the RELOAD KIT command found in the KIT menu. For more information, please see "9.2 KIT MENU" on page 25.

To quick reload the track Sound of the active track, press [NO/RELOAD] + [KEYBOARD D1].

To quick reload a track, press **[NO/RELOAD] + [KEYBOARD E1]**. The operation is the same as the RELOAD TRACK command. For more information, please see “10.12.12 QUICK SAVE AND RELOAD COMMANDS” on page 51.

To quick reload the active pattern, press **[NO/RELOAD] + [KEYBOARD F1]**. The operation is the same as the RELOAD PATTERN command. For more information, please see “10.5.1 RELOAD PATTERN” on page 42.

To quick reload a song, press **[NO/RELOAD] + [KEYBOARD G1]**. The command is the same as the RELOAD command found in the SONG menu. For more information, please see “11.2.4 SONG MENU” on page 55.

11. CHAINS AND SONGS

Chains are sequences consisting of several patterns. Chains and patterns can be used to form songs.

256 pattern entries are available for the 64 chains. One chain, for example, can be made of 256 patterns or two chains can be made of 128 patterns each. In most scenarios, using 2-8 patterns per chain is sufficient.

One song is always active and being worked on. Songs contain two main forms of entries, song rows, and a scratch pad row. The active song row is visible on the graphics located in the lower left part of the LCD. If a scratch pad row is active, the graphics will show “_ _.” The scratch pad row is by default placed after all song rows.

Each song row contains a chain or a pattern. These entries are saved together with the song. The scratch pad row also contains a chain or a pattern and is also saved as a part of the song. The intended use of the scratch pad row is for quickly experimenting with chains and patterns without affecting already programmed song rows.

11.1 CHAINS

If the active song row or scratch pad row contains a chain, all patterns of the chain will be played when activating the CHAIN mode by pressing **[CHAIN MODE]**. When deactivating the mode, and SONG mode is not active, the currently active pattern will be played over and over. The currently active pattern, and any other patterns in the chain are visible in the lower left corner of the LCD screen. The active pattern is shown with inverted color.

There are two ways to create chains: Detailed chain mode and Quick chain mode.

11.1.1 DETAILED MODE

CHAIN mode must be active if you want to create chains in detailed mode. Create chains in detailed mode by pressing **[CHAIN MODE]** + **[LEFT]/[RIGHT]** to move the chain cursor. It can either be placed before a pattern, on a pattern or after a pattern. If the cursor is placed before a pattern and a new pattern is selected by pressing **[BANK X/X]** + **[TRIG]**, the selected pattern will be inserted before the pattern located after the cursor. If the cursor is highlighting a pattern and a new pattern is selected, the highlighted pattern will be replaced. When activating CHAIN mode, the patterns in the chain will be played in sequence. The chain will be looped once the final pattern of the chain has played.

11.1.2 QUICK MODE

To create chains in quick mode, press and hold **[BANK X/X]** and then press the **[TRIG]** key for the pattern you want the chain to start with. As long as you keep the first **[TRIG]** key pressed, subsequent **[TRIG]** keys pressed will add patterns to the chain. In quick mode, it is only possible to chain patterns from the same bank. Please note that the previous chain will be erased when using quick mode. PAT-TERN mode must be set to SEQUENTIAL if you wish to create chains in quick mode.

Pressing **[CHAIN MODE]** + **[NO/RELOAD]** will, depending on the location of the chain cursor, either erase the pattern located before the cursor or the one highlighted by it.

Pressing **[FUNCTION]** + **[CHAIN MODE]** will create a new, blank, scratch pad row. The scratch pad row will be placed at the very bottom of the song row list (which can be seen when opening the SONG EDIT menu). The content of the previous scratch pad row will be added as a new song row following the last song row. See SONG EDIT MENU on how to relocate song rows (including the scratch pad row) within the song.



CHAIN mode is ideal when improvising live. When CHAIN mode is deactivated and only the currently active pattern is looping, create a chain and then activate CHAIN mode. At any time, exit CHAIN mode to loop one pattern only. Add and remove patterns to create a completely new chain and activate CHAIN mode again. By creating new chains through pressing **[FUNCTION] + **[CHAIN MODE]**, improvised songs can quickly be created.**

11.2 SONGS

Songs are essentially patterns and chains structured to form a longer sequence. To enter SONG mode, press the **[SONG MODE]** key. The <SONG> LED will light up, indicating SONG mode is active. The active song will start to play, row by row. If the active song row is the scratch pad row (in its bottom-of-the-stack default position) it will play through its chain of patterns once, then stop. If the scratch pad row has been moved within the song, it will play the following song row. The song row playing is shown in the lower left corner of the LCD screen.

11.2.1 SONG EDIT MENU

Songs are created in the SONG EDIT menu, which is accessed by pressing **[FUNCTION]** + **[SONG MODE]**.

```

--: 1x  A01 A02 A03      | ■120.0
00: 4x  E01             | 0001:1
01: 1x  004 E05 E11 C16 | T-64
02: 1x  H01             | ████████
                          | -----

```

Songs are played row by row, starting from the top and moving towards the bottom. If a song row contains a chain, all patterns in the chain will play before the song play position moves to the next row. The song play position is indicated by inverted pattern number graphics. In the top right corner of the LCD screen the BPM and the amount of played bars and beats is shown.

To navigate between song rows as well as patterns assigned to the song rows, use the **[ARROW]** keys. When the song cursor highlights a pattern position, the pattern number becomes enclosed by a square. When the song cursor is placed before or after a pattern, it will form a thin line.

To start playing a Song from the beginning, double-press **[STOP]**. The song play position will automatically be moved to the first pattern of the first song row. Songs can, however, start playing from any pattern position. Highlight a pattern position by moving the song cursor using the **[ARROW]** keys. Press **[YES/SAVE]** to select this position. The graphics will become inverted, indicating this is the song play position. Press **[PLAY]** to start playing the Song from this position.



Copy, paste, and clear commands can be executed on the song rows.

11.2.2 ADDING SONG ROWS AND ASSIGNING PATTERNS AND CHAINS

Press **[FUNCTION]** + **[YES/SAVE]** to add a song row. The new song row will be inserted below the row on which the cursor is, and the pattern A01 will automatically be assigned to the new row. To assign another pattern to the song row, use the **[ARROW]** keys to move the song cursor, so the pattern assigned to the row becomes highlighted and then press a **[BANK X/X]** key + a **[TRIG]** key. In general, the pattern assigning procedure is the same as when selecting a pattern. For more information, please see “10.1.1 SELECTING A PATTERN” on page 38.

To add a chain to a song row, select a song row and press the **[RIGHT]** arrow key. The song cursor will move from the pattern position and become a line. Press a **[BANK X/X]** key + a **[TRIG]** key to select the pattern that will be added to the chain.

Remove a pattern in a chain by highlighting it with the song cursor and pressing **[FUNCTION]** + **[NO/RELOAD]**.

If a song row contains a chain, individual patterns can be rearranged in the chain. Select the pattern by highlighting it with the song cursor and press **[FUNCTION]** + **[LEFT]/[RIGHT]**.

Move a song row up or down in the song by moving the song cursor to the song row and pressing **[FUNCTION]** + **[UP]/[DOWN]**. Note that the scratch pad row “_ _:” can be moved up or down in the list in the same way. The position of the scratch pad row is important, because it determines where the new song row will be located when a new chain (and a new scratch pad row) is created outside of the SONG EDIT menu. The new song row will be inserted above the new scratch pad row, and it will have the same number as the song row below the previous scratch pad row.

Erase an entire song row, one pattern at a time, by repeatedly pressing **[FUNCTION]** + **[NO/RELOAD]**.

11.2.3 ADDING REPEATS, MUTES AND TRANSPOSE INFORMATION

Various extra information can be entered for song rows and pattern or patterns assigned to the song rows.

Repeat a song row with a chosen factor by moving to the leftmost position of the song row. Turn **DATA ENTRY** knob **A** to select how many times the song row will be repeated.

Add song mutes to a pattern by highlighting it and pressing **[FUNCTION]** + **[TRACK]**. The mute graphics to the right in the LCD screen shows which tracks have been muted. Tracks muted from a song are also indicated by half-bright <TRACK> LEDs. Unlike track mutes, song mutes are pattern specific. Different patterns can have different song muted tracks. When not in SONG EDIT menu and song muted tracks are manually muted by pressing **[FUNCTION]** + **[TRACK]**, the <TRACK> LEDs will become unlit, i.e., track muted.

Transpose a pattern by highlighting it with the song cursor and pressing **[TRANPOSE]** + the **[KEYBOARD]** keys. A song transpose works like a track transpose, albeit automated. For more information, please see "10.12.9 TRACK TRANSPOSE" on page 50.

11.2.4 SONG MENU

In the SONG menu, songs can be saved, loaded renamed et cetera. Access the menu by pressing **[FUNCTION]** + **[KEYBOARD G1]**.



RELOAD will reload the active song. It will be restored to its saved version. Press **[NO/RELOAD]** + **[KEYBOARD G1]** for a short cut to this command.

LOAD will open a menu where saved songs can be loaded. Inverted graphics indicate the active song.

SAVE will save the active song to one of the 16 song slots. Inverted graphics indicate the active song. Press **[YES/SAVE]** + **[KEYBOARD G1]** for a short cut to this command.

CLEAR will clear the active song from all content.

EDIT will open the EDIT menu. It is the same menu as accessed by pressing **[FUNCTION]** + **[SONG MODE]**. See page 44 for more info about this menu.

RENAME will open a menu where the active song can be renamed.

12 GLOBAL MENU

The GLOBAL menu offers settings that affect the Analog Four on a global level. Global tune, MIDI and CV settings are made here. Up to four Global slots, where each can have individual settings, are available.

Access the menu by pressing [FUNCTION] + [KEYBOARD C2]. Scroll the list by using [UP]/[DOWN] or the LEVEL knob. Open a highlighted menu by pressing [YES/SAVE].



12.1 PROJECT

Manage projects here. This menu is covered in the section "PROJECTS" on page 13.

12.2 GLOBAL SLOT

Selects which of the four Global slots to use. Select the active slot by using the [LEFT]/[RIGHT] arrow keys. Press [YES/SAVE] to confirm the selection. All changes made to a Global slot are automatically saved. A slot stores the current configuration of the synth, sequencer, CV and MIDI settings. All changes made to a Global slot are automatically saved.

12.3 MASTER TUNE

The Analog Four master tune settings are found here.



12.3.1 MASTER TUNE

Sets the master tune for the analog oscillators. The default setting is the international standard middle A, 440.0 Hz. The tuning across all octaves is done according to the 12-TET convention.

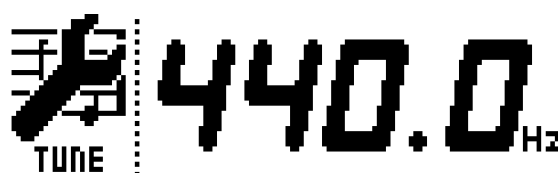

12.4 SEQUENCER CONFIG

Sequencer settings are found here. Change settings by using the [LEFT]/[RIGHT] arrow keys.



12.4.1 QUANTIZE LIVE REC

Will when active quantize notes entered in LIVE RECORDING mode to full sequencer steps. When the setting is deactivated, live recorded notes will where applicable be affected by micro timing. For more information, please see "10.8 NOTE MENU" on page 44.

12.4.2 KIT RELOAD ON CHG

Will cause kits to reload to their saved state automatically as soon as a new kit becomes active. This is useful if you, for example, play live and have tweaked a kit, want to save it and then return to a pattern featuring the same kit, but with its original settings.

12.5 MIDI CONFIG

In this menu, various sub-menus dealing with the MIDI functionality of the Analog Four are found.



12.5.1 SYNC

Controls how the Analog Four receives and sends MIDI clock and transport commands. Change settings by using the [LEFT]/[RIGHT] arrow keys.



CLOCK RECEIVE will when active make the Analog Four respond to MIDI clock sent from external devices.

CLOCK SEND will when active make the Analog Four transmit MIDI clock.

TRANSPORT RECEIVE will when active make the Analog Four respond to system realtime messages like play, stop, continue and song position pointer.

TRANSPORT SEND will when active make the Analog Four send out system realtime messages like play, stop, continue and song position pointer.

PRG CH RECEIVE will when active make the Analog Four respond to incoming program change messages, which is useful when wanting to select patterns externally. The MIDI channel that will listen to incoming program change messages is set in the MIDI CHANNELS menu. For more information, please see "12.5.3 CHANNELS" on page 58.

PRG CH SEND will when active send program change messages when patterns are changed. The MIDI channel that will send program change messages is set in the MIDI CHANNELS menu. For more information, please see "12.5.3 CHANNELS" on page 58.

12.5.2 PORT CONFIG

MIDI port related settings are found in this menu. Change settings by using the [LEFT]/[RIGHT] arrow keys.



TURBO SPEED selects the multiplier of the MIDI transfer rate that will be used when the Analog Four MIDI IN/OUT ports are connected to the MIDI OUT/IN ports of a turbo protocol compatible device. The [LEFT]/[RIGHT] arrow keys are used to select the multiplier. If AUTO is chosen, press [YES/SAVE] to start the turbo speed negotiation.

OUT PORT FUNCTIONALITY selects what type of signal the MIDI OUT port will send.

MIDI makes it possible for the port to send out MIDI data.

DIN 24 will make the port send DIN 24 sync messages. No MIDI data can be sent when this option is selected.

DIN 48 will make the port send DIN 48 sync messages. No MIDI data can be sent when this option is selected.



On DIN 24/48 operation: When the [STOP] key is pressed twice quickly, the DIN sync outputs are put in a ready to start mode. In this mode, the synced unit will start directly when the sequencer starts. When in this mode, an external unit (for example a TB-303) cannot be programmed. Exit the ready to start mode by pressing [STOP] once.

THRU PORT FUNCTIONALITY selects what type of signal the MIDI THRU port will send. The available settings are the same as for OUT PORT FUNCTIONALITY above.

INPUT FROM selects the source the Analog Four will receive MIDI data from.

DISABLED will make the Analog Four disregard any incoming MIDI data.

MIDI will make the Analog Four listen only to MIDI data sent to the MIDI IN port.

USB will make the Analog Four listen only to MIDI data sent to the USB port.

MIDI+USB will make the Analog Four listen to MIDI data sent to both the MIDI IN and USB ports.

OUTPUT TO selects the destination to which the Analog Four will send MIDI data.

DISABLED will stop the Analog Four from sending out any MIDI data.

MIDI will make the Analog Four send MIDI data to the MIDI OUT port only.

USB will make the Analog Four send MIDI data to the USB port only.

MIDI+USB will make the Analog Four send MIDI data to both the MIDI OUT and USB ports.



If **MIDI+USB** is selected in the **OUTPUT TO** settings, MIDI data will limit the USB speed. When sending large chunks of data, make sure you only use the USB setting.

OUTPUT CH selects whether the mini-keyboard and the knobs will send data on the AUTO CHANNEL or the MIDI channel of the selected track.

PARAM OUTPUT selects what type of MIDI messages the **DATA ENTRY** knobs will send. For more information, please see "APPENDIX D: MIDI" on page 97.

NRPN will make the knobs send out NRPN MIDI messages.

CC will make the knobs send out CC MIDI messages.

ENCODER DEST controls whether the **DATA ENTRY** and **LEVEL** knobs will send MIDI data or not. When set to INT, no MIDI data will be sent. When set to INT + EXT, MIDI will be sent internally as well as externally.

KEYBOARD DST controls whether the [KEYBOARD] keys will send MIDI note data or not. When set to INT, no MIDI data will be sent. When set to INT + EXT, MIDI will be sent internally as well as externally. When set to EXT, MIDI will only be sent externally.

MUTE DEST controls whether track mute/unmute will send MIDI CC/NRPN messages or not. When set to INT, no MIDI data will be sent. When set to INT + EXT, messages will be sent internally as well as externally. When set to EXT, messages will only be sent externally.

RECEIVE NOTES will when active make it possible to play the Analog Four using an external MIDI keyboard.

RECEIVE CC/NRPN will when active make it possible to control Analog Four parameters from an external MIDI device sending CC/NRPN data.

LIVE REC ON TRACK CHANNEL when the box is ticked, active LIVE RECORDING will record incoming MIDI notes on each of the specified track channels (see below). When unticked, LIVE RECORDING will not (but still record on the currently active track via the auto channel).

12.5.3 CHANNELS

This menu handles the MIDI channel configuration.

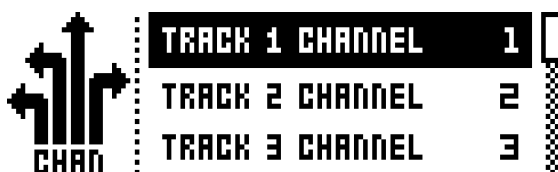

TRACK 1-4, FX, CV selects dedicated MIDI tracks that will control the synth, FX, and CV tracks. An OFF setting will make the track disregard any incoming MIDI messages.

PERF CHANNEL selects the MIDI channel the knobs will send MIDI data on when PERFORMANCE mode is active.

AUTO CHANNEL selects the MIDI channel that will give access to the currently active track. If an external MIDI keyboard connected to the Analog Four sends MIDI data on this channel, the keyboard will control the active track. This is useful when for example quickly changing between the active synth tracks to play different Sounds.

PROGRAM CHANGE IN CHANNEL selects the MIDI channel that will listen for incoming program change messages. An AUTO setting will use the AUTO channel. Enable the Analog Four to respond to program change messages in the MIDI SYNC menu. For more information, please see “12.5.1 SYNC” on page 57.

PROGRAM CHANGE OUT CHANNEL selects the MIDI channel that will send program change messages when changing patterns. An AUTO setting will use the AUTO channel. Enable the Analog Four to send program change messages in the MIDI SYNC menu. For more information, please see “12.5.1 SYNC” on page 57.

12.5.4 MULTI MAP EDIT

Opens an editor for mapping the functions of single notes or note range on an external MIDI keyboard. The functions that can be mapped include: Internal triggering of Sounds on any track, triggering of MIDI notes on any MIDI channel and the ability to trig patterns with custom transpose and timing settings. Multi map allows custom mapped keyboards splits, pattern triggering per key, Sound trig per key, MIDI trig of external synths, and more. In the Multi map mode, for example, full analog drum kits, bass lines, and lead sounds can be played simultaneously. Ideal for performances and live improvisations.

Additionally, the internal multi map trigs can be recorded with the Analog Four sequencer. At most, one unique function may be mapped for each of the 128 keys of the entire MIDI keyboard range. One multi map setting is stored for each global slot, which means 4 different keyboard maps per project can be used.

```
ENTRIES  <CREATE NEW ENTRY>
          <CREATE SPLIT>
```

ENTRIES are the basic building blocks of the multi map. They define what function will be assigned to each key or key range. Up to 128 entries may be created per multi map. If no entries exist, select **ENTRIES**, and then **CREATE NEW ENTRY**. If you wish to erase all entries to start anew, select **ENTRIES** and choose **CLEAR ALL ENTRIES**. If you wish to use the default multi map, a keyboard split, choose **CREATE SPLIT**. Select the entry to edit in the left part of the display by using the **[UP]/[DOWN]** arrow keys and press **[YES/SAVE]**. The cursor will move to the right part of the display where the list of mapping alternatives is visible.

To edit a multi map entry, navigate by using the **[UP]/[DOWN]** arrow keys. Change the highlighted item in the list by pressing the **[LEFT]** or **[RIGHT]** arrow keys.

Note that the map entries may be instantly tried by playing the specified range on your external MIDI keyboard or the Analog Four **[KEYBOARD]** keys.



To use your custom multi map, remember to set the external MIDI keyboard to the assigned **PERF CHANNEL** (or change the performance channel in the **MIDI CHANNEL** menu to that of the MIDI keyboard)

```
ENTRIES  FUNCTION INT. TRIG
C D-E S  RANGE LOW    C 0
F S-F S  RANGE HIGH  E 5
          TRACK      AUTO
```

FUNCTION selects one of the four main types of functionality for the MIDI mapping.

- **INT.TRIG** sets the chosen MIDI keyboard key or range to control specific Sounds from the Sound pool or the +Drive Sound library.

RANGE LOW sets the note on the keyboard on which to start the desired keyboard range.

RANGE HIGH sets the note on the keyboard on which to end the desired keyboard range. If a single key is to be mapped, set to the same note as RANGE LOW.

TRACK sets which track the selected keyboard range or key will play. AUTO will play the active track, while TRK 1, TRK 2, TRK 3, TRK 4, FX TRK and CV TRK sets the range to play the specific synth, FX or CV track of your choice.

NOTE sets which note the start of the chosen keyboard range will play. If no offset is desired, it should be set to the same note as RANGE LOW.

NOTE INC defines by what increment the subsequent notes played will increase. For instance, if this value is set to 2, and the first note in the range is C5, the following note in the range will play D5, the one after that E5 and so on. If set to 0, all notes in the keyboard range will play the same note (as set in NOTE above). If a 1:1 correspondence is desired, set to 1.

SOUND SLOT sets which one of the 128 Sounds, found in the Sound pool of the active project, the keyboard range will play. If set to OFF, the track Sound of the chosen TRACK above will be played.

SOUND INC sets by what increment the next key in the chosen keyboard range will play the next sound slot Sound. If set to 0, the same Sound as defined above will be played across the whole defined range. If set to 1, it will play the next successive sound slot Sound for each successive key pressed. Setting the value to 2 will play every other Sound starting from the sound slot, setting it to 4 every fourth and so on.



In **MULTI MAP EDIT**, Setting a specific **SOUND SLOT** and setting **SOUND INC** to 1 is convenient if you wish to define, for example, a succession of drum sounds that you have stored in a given sound slot range to be mapped to a certain section of the keyboard. Instant access to those snares, kicks, and hi-hats!

FIXED VEL will, if set to OFF, make the velocity sensitivity of the MIDI keyboard work as usual. It may also be set to a constant specific value between 1 and 127, 1 being the lowest and 127 the highest possible velocity.

DELETE ENTRY deletes the whole entry. Select and confirm by pressing **[YES/SAVE]**.

INSERT BEFORE will create a new entry with a range ending on the note preceding the current entry. Select by pressing **[YES/SAVE]**.

INSERT AFTER will create a new entry with a range beginning on the note succeeding the current entry. Select by pressing **[YES/SAVE]**.

- **EXT.TRIG** allows MIDI control of external equipment for a chosen keyboard key or range.

CHANNEL sets which specific MIDI channel on which the MIDI note messages are to be sent, or AUTO.

NOTE sets which note the start of the chosen keyboard range will play.

NOTE INC defines by what increment the subsequent notes played will increase.

FIXED VEL will, if set to OFF, make the velocity sensitivity of the MIDI keyboard work as usual. It may also be set to a constant specific value between 1 and 127.

DELETE ENTRY deletes the whole entry. Select and reconfirm by pressing **[YES/SAVE]**.

INSERT BEFORE will create a new entry with a range ending on the note preceding the current entry. Select by pressing **[YES/SAVE]**.

INSERT AFTER will create a new entry with a range beginning on the note succeeding the current entry. Select by pressing **[YES/SAVE]**.

- **NONE** sets a keyboard key or range that will not be used for any function. Convenient for defining a 'no-play' zone on the keyboard between two or more sections with different Sounds or functions.

RANGE LOW sets the note on the keyboard on which to start the desired keyboard range.

RANGE HIGH sets the note on the keyboard on which to end the desired keyboard range.

DELETE ENTRY deletes the whole entry. Select and confirm by pressing **[YES/SAVE]**.

INSERT BEFORE will create a new entry with a range ending on the note preceding the current entry. Select by pressing **[YES/SAVE]**.

INSERT AFTER will create a new entry with a range beginning on the note succeeding the current entry. Select by pressing **[YES/SAVE]**.

- **PAT.PLAY** maps a chosen pattern to a specific MIDI keyboard key or range.

RANGE LOW sets the note on the keyboard on which to start the desired keyboard range.

RANGE HIGH sets the note on the keyboard on which to end the desired keyboard range.

PATTERN selects which pattern A01 - H16 of the active project will be played when pressing a keyboard key in the range specified above. Set to CUR if the current pattern is to be played.

PATTERN INC selects the increment with which the pattern will increase for each successive key press in the specified range. For example, if set to 1, each successive key will start pattern A01, A02, A03 and so on. Set to 2 it will play pattern A01, A03, A05 et cetera. Set to 0 if the same pattern as set in PATTERN above is to be played for every key in the range.

TRANSPOSE transposes the pattern up or down 1-36 semitones. No transpose if set to 0.

TRANSPOSE INC sets the increment by which the transpose will be increased for each step of the chosen keyboard range. No increase if set to 0.

CHG MODE sets the mode of starting the pattern. D.START starts the selected pattern directly from its first step. D.JUMP starts the selected pattern on the step following the current sequencer step. SEQ starts the pattern from its first step once the current pattern has reached its final step.

DELETE ENTRY deletes the whole entry. Select and confirm by pressing [YES/SAVE].

INSERT BEFORE will create a new entry with a range ending on the note preceding the current entry. Select by pressing [YES/SAVE].

INSERT AFTER will create a new entry with a range beginning on the note succeeding the current entry. Select by pressing [YES/SAVE].

12.6 CV CONFIG

CV/Gate output signals are calibrated and set up in this menu.

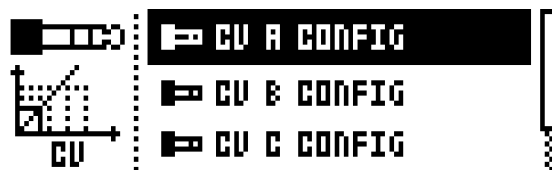

12.6.1 CV A-D CONFIG

Each of the subpages is identical and one for each CV/Gate output exists. The list of available parameters in this menu will depend on the menu settings. When the CV track is active, pressing [FUNCTION] + [CV A-D] is an alternate way of opening this menu for each corresponding CV/Gate output.

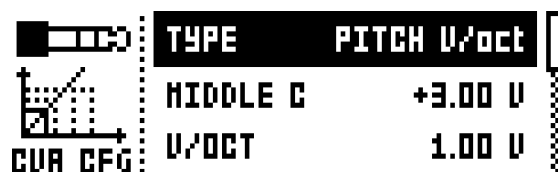

Please read the following paragraphs on how to set up CV pitch control. CV pitch is configured by finding the voltages generating two different notes from the synthesizer you wish to control. To get a good result, you should select the notes two or three octaves apart.

Before configuring the pitch output, you should setup a gate output so that notes can be triggered on the receiving end. You should also set up the gate and pitch parameters so that they use the same source track for triggering notes.



Select NOTE 1 (for example C3). Then highlight VOLTAGE 1 and press the **[YES/SAVE]** key. This will trigger a C3 note which is played for as long as you hold down the key. While keeping **[YES/SAVE]** pressed, adjust the voltage until the controlled synthesizer actually plays the note C3 using **[ARROW]** keys **[LEFT]/[RIGHT]** or **DATA ENTRY KNOB A**. If you don't have a tuning device, we recommend you play the corresponding note on one of the internal tracks and tune by ear.

Repeat the process for NOTE 2 and VOLTAGE 2, but choose, for example, C5 or C6. Finally, play some random notes to see if they are in tune. If not, then you probably need to change from PITCH V/OCT to PITCH HZ/V, or vice versa.

TYPE selects the type of signal that will be sent from the output. GROUNDED, PITCH V/OCT, PITCH HZ/V, VALUE LIN, TRIG and GATE settings can be made. Depending on the selection, different parameters will be available.

GROUNDED turns the CV output off. No additional parameters available.

PITCH V/OCT should be chosen for controlling the pitch of equipment using the volt per octave standard, which applies to most analog synthesizers.

PITCH HZ/V should be chosen for controlling the pitch of equipment using the Herz per volt standard, which applies to, for example, older Korg and Yamaha synths.

VALUE LIN is used to send out arbitrary control voltages, useful when for instance sequencing or parameter locking any voltage-controlled parameters on analog equipment.

VALUE MIN sets the lowest allowed voltage level that can be sent from the CV/Gate output.

VALUE MAX sets the highest allowed voltage level that can be sent from the CV/Gate output. Normally it is not dangerous to connect voltages within +/- 15 V to analog equipment, but use these limitations if you are unsure.

TRIG is used to send out short trig pulses at the start of note events.

LENGTH selects the length of trig signals sent. Some equipment might not trig correctly on the shortest pulses, so try different lengths if you experience problems when trying to trig.

POLARITY selects the polarity of trig signals sent. V-TRIG and S-TRIG options exist. V-trig (voltage trigger) is a trig pulse going from 0 V to a user-defined voltage level. S-TRIG (short circuit trigger) goes the other way, from a user-defined voltage level to 0 V. V-TRIG is the most common trig polarity. S-TRIG is primarily used by older Moog, Korg and Yamaha synths.

LEVEL selects the level of trigs sent, measured in volts. The standard logic level of +5 V is enough to trig most equipment, but some might need higher voltages to react.

GATE gives a longer pulse, with a duration of the whole note length.

POLARITY works as the same parameter available when TYPE is set to TRIG.

LEVEL works as the same parameter available when TYPE is set to TRIG.

CLOCK will send periodical pulses with a period synced to the sequencer step length.

CLK sets the clock division of the pulse.

12.6.2 VOLTAGE TRIM

It is possible to trim the CV out voltage levels. These settings are stored in the machine without being connected to any specific Project. Adjusting these values is mainly useful if you wish to send pulses with very exact voltage levels or to generate very specific voltages as a linear value and you believe that the factory trim is off.



Make sure you have a good voltmeter before proceeding. Connect a TRS cable to the output you want to trim. Connect the volt meter's negative terminal to the sleeve of the connector. Connect the positive terminal to either the tip or the ring of the connector, depending on the channel you wish to trim.



Each CV output has three trim settings. Begin by selecting 0 V, then press and hold the [YES/SAVE] key. 0 V is output as long as [YES/SAVE] is held down. Use [ARROW] keys [LEFT]/[RIGHT] or *DATA ENTRY KNOB A* to adjust the voltage until your voltmeter shows exactly 0 V. Repeat the process for both 8 V settings (the first one is for continuous voltage, the second is for pulse).

Note that adjusting the CV does not improve CV pitch control. If you have set up pitch control of an external synth properly then, any linear error has already been compensated for by that calibration. In fact, you will have to reconfigure the CV pitch control after changing the values in the VOLTAGE TRIM Menu, because you will have changed the point of reference.

12.7 AUDIO ROUTING

This menu item accesses the global routing of the four voices.



Activate/deactivate routing of any the four voices to the main output and the FX track. Navigate using the [ARROW] keys. Tick or untick box with the [YES/SAVE] key.

Alternatively, instantly activate or deactivate voice to main or voice to FX using the [TRIG] keys 1-4 and 9-12, respectively. Red LEDs above these sets of keys will show if the voice is active (full-bright) or inactive (half-bright).

Note that voice routing can be set and stored for each individual kit and that these settings override the GLOBAL voice routing unless they are set not to. For more information, please see “9.2 KIT MENU” on page 25.

USB TO MAIN [db] sets the gain level of the audio sent over USB to the Analog Four. This setting only affects the audio sent from the USB audio host to the analog MAIN OUT L/R and HEADPHONES outputs. This parameter is only available if OVERBRIDGE mode is chosen in the USB CONFIG menu. For more information, please see “12.9.1 USB CONFIG” on page 65. (0 dB–+18 dB)

12.8 SYSEX DUMP

In the SYSEX DUMP menu, kits, Sounds, patterns, songs and global slots can be sent and received. Select a menu option using [UP]/[DOWN] or the *LEVEL* knob. Press [YES/SAVE] to open the highlighted menu selection.



When receiving or sending SysEx data, the MIDI ports or the USB port of the Analog Four should be connected to the external sending/receiving device.

If the Analog Four is sending or receiving SysEx data through the MIDI ports, use the Elektron TM-1 USB MIDI interface for up to 10x transfer speeds.

If the external device is a computer, we recommend using our free SysEx utility C6, which can be downloaded from the Elektron website.

12.8.1 SYSEX SEND

Here kits, Sounds, patterns, songs and global slots can be sent to an external device via the MIDI OUT port or the USB port of the Analog Four.



The column to the left selects what will be backed up. Select the column using the [LEFT] arrow key. Use the [UP]/[DOWN] keys or the **LEVEL** knob to navigate in the column. The SysEx data send alternatives located in the column to the right will change depending on the selection made in the left column. Press the [RIGHT] arrow key to access this column. Use the [UP]/[DOWN] keys or the **LEVEL** knob to select what will be sent. Press [YES/SAVE] to initiate the SysEx send procedure.

ALL offers the possibility to do complete backups of various data.

WHOLE PROJECT will send all kits, Sounds, patterns, songs and global slots to the receiving device. I.e., the complete project.

ALL SOUNDS will send all sounds to the receiving device.

ALL KITS will send all kits to the receiving device.

ALL PATTERNS will send all patterns to the receiving device.

ALL SONGS will send all songs to the receiving device.

ALL GLOBALS will send all global slots to the receiving device.

ALL SETTINGS will send all settings to the receiving device.

KIT will send the selected kit to the receiving device. An asterisk at the end of the kit name indicates the kit is not linked to any pattern.

SOUND will send the selected Sound to the receiving device.

PATTERN will send the selected pattern to the receiving device. To the right of the pattern slot, the name of the kit linked to the pattern is visible. An asterisk indicates the pattern is not linked to a kit.

PATTERN + KIT will send the selected pattern plus its associated kit to the receiving device.

SONG will send the selected Song to the receiving device.

GLOBAL will send the selected Global slot to the receiving device.



Backing up your data regularly is important!

Before initiating a SysEx send, first, make sure the receiving device is listening for data to be sent.

12.8.2 SYSEX RECEIVE

Here kits, Sounds, patterns, songs and global slots can be received from an external device via the MIDI IN port or the USB port of the Analog Four.



The column to the left selects what will be received. Select the column using the [LEFT] arrow key. Use the [UP]/[DOWN] keys or the **LEVEL** knob to navigate in the column. The SysEx data receive alternatives located in the column to the right will change depending on the selection made in the left column. Press the [RIGHT] arrow key to access this column. Use the [UP]/[DOWN] keys or the **LEVEL** knob to select what will be received. Press [YES/SAVE] to initiate the SysEx receive procedure. The Analog Four will start listening to incoming data. Press [NO/RELOAD] to stop listening.

ANYTHING will listen to and receive any viable SysEx data sent.

KIT

ACTIVE KIT will when receiving kit SysEx data replace currently active kit with the received kit.

KIT 01-128 will store a received kit to the selected kit slot. An asterisk at the end of the kit name indicates the kit is not linked to any pattern.

SOUND POOL will store a received Sound to the selected slot of the Sound Pool of the active project.

+DRIVE SOUND will store a received Sound to the selected slot of the +Drive Sound library. The option ANYWHERE will place the Sound in the first free slot available. To the right of the bank indication, the amount of free slots can be seen.

PATTERN will store a received pattern to the selected pattern slot. To the right of the pattern slot, the name of the kit linked to the pattern is visible. An asterisk indicates the pattern is not linked to a kit.

SONG will store a received song to the selected song slot.

GLOBAL will store a received global to the selected global slot.



Initiate the SysEx send from the sending device after the Analog Four has started listening to incoming data.

When receiving to a specific list position, any subsequent data will be received on the next position, or positions, in the list.

The Analog Four can receive SysEx data at any time, regardless of the currently active menu. The data will be loaded into the position specified when it was saved, or the first free slot if unspecified.

12.9 SYSTEM

Accesses the menus USB CONFIG, OS UPGRADE, FORMAT +DRIVE and CALIBRATION described below.

12.9.1 USB CONFIG

To use the Analog Four as an Overbridge device, you must set it to Overbridge mode. Do so by selecting the OVERBRIDGE menu item and ticking the box by pressing [YES/SAVE]. For more information, please see "6.6 OVERBRIDGE" on page 19.



Should you, for some reason, wish to disable the Overbridge integration functionality, select the item called USB MIDI and press [YES/SAVE].

12.9.2 OS UPGRADE

This menu option is used when you want to upgrade the Analog Four OS. To send the OS syx file, use our free Elektron Transfer software. The OS syx file and Elektron Transfer can be downloaded from the Elektron website.

For the transfer to be possible, the device sending the OS syx file must be connected to the USB port of Analog Four.

Please note that the Analog Four will not appear as an icon on your computer desktop.

1. Connect the Elektron device to the computer via USB.
2. Open the Transfer application on your computer.
3. On the Transfer CONNECTION page, set the MIDI IN and MIDI OUT ports to your Elektron device.
4. On the Transfer DROP page, drag and drop the OS file. The OS file is then automatically transferred to the Elektron device and the OS update initiates. A progress bar is visible on device screen when receiving the OS.
5. On your device. Press [YES] to confirm the OS update.

When the process is successfully completed, the OS is updated and the unit reboots.

12.9.4 CALIBRATION

Starts the calibration routine for the oscillators, pulse widths, and filters. After selecting this option, a popup window asking to confirm the calibration will appear.



Press [YES/SAVE] to proceed with the calibration. Please note the calibration routine takes a while to complete.



The Analog Four is factory calibrated. It should not be re-calibrated unless specifically stated by Elektron Support.

13. STARTUP MENU

To access this menu, hold down the [FUNCTION] key while powering up the Analog Four. From here you can perform a variety of tasks. To choose the different alternatives, press the corresponding [TRIG] key.

```

ANALOG MENU
1 ... TEST MODE
2 ... EMPTY RESET
3 ... FACTORY RESET
4 ... OS UPGRADE

```

13.1 TEST MODE

To enter this mode, press the first [TRIG] key. If you have any trouble with your Analog Four and suspect it may be due to a hardware problem, you should perform this self-test. No errors should be reported as shown below. If you get an error, contact Elektron support or the retailer you bought the Analog Four from.

```

TEST MODE
0 ERRORS
UI:[+]
NVRAM:[+]

```

13.2 EMPTY RESET

To perform this operation, press the second [TRIG] key. All kits, patterns, Sounds and songs will be erased.

13.3 FACTORY RESET

When performing a factory reset on the Analog Four it will overwrite and re-initialize the active project (including all pattern, kit, sound pool and global data). The +Drive project slot 1 will be overwritten and re-initialized. Sound bank A and B will be overwritten with the factory Sounds. Factory preset patterns, kits, Sounds and settings will be re-initialized.

If you wish to keep the active project, remember to save it to a +Drive project slot higher than 1 before you perform a factory reset. To perform a factory reset, press [TRIG] key 3.



When you are in the STARTUP menu, you also have the possibility to perform a total reformatting of the +Drive and at the same time perform a factory reset. Please keep in mind that it will empty the +Drive of all your presets and patterns and reset it to the factory content only. To reformat the +Drive and make a factory reset, press [SONG] + [CHAIN] + [TRIG 3].

13.4 OS UPGRADE

Choose this option by pressing the fourth [TRIG] key. Use this menu option if you for some reason can't upgrade the Analog Four OS using the standard procedure in the SYSTEM menu. To send the OS file, use our free Elektron Transfer software. The Elektron Transfer can be downloaded from the Elektron website.

1. Download the Analog Four OS file from the Elektron website.
2. Connect the Analog Four's MIDI IN port to the MIDI OUT port of the computer's MIDI interface.
3. Hold down the [FUNC] key while powering on Analog Four. This takes you to the STARTUP menu.
4. Press the [TRIG 4] key to enter OS UPGRADE mode.
5. Open the Transfer application on your computer. On the Transfer CONNECTION page, click "go to the SYSEX TRANSFER page".
6. On the SYSEX TRANSFER page, click "OS Upgrade via device startup menu", and then follow the on-screen instructions.

When the update is done, the Analog Four will reboot.



USB MIDI transfer is not possible when upgrading the OS from the STARTUP menu.

14. MORE ON OSCILLATORS, FILTERS, AND ENVELOPES

In this chapter, the functionality of the oscillators, filters, and envelopes will be explained in further detail.

14.1 OSCILLATORS

Several waveforms are available to the two oscillators of each synth track. By adjusting the **PW** parameter, the waveshape can be changed on all types of waveforms, changing their timbre. Furthermore, each oscillator has a dedicated **PWM** LFO, giving animation to the sound using pulse-width modulation.

SAW

This waveform has a biting, buzzy and distinct sound. It contains all harmonics, both odd and even, of the fundamental frequency. Classic synth basses, strings, and brass sounds are often created using sawtooth waveforms. The **PW** parameter brings in a second sawtooth, out of phase with the first one. Changing the **PW** value or engaging **PWM** varies the phase difference between the two, similar to having two slightly detuned oscillators running. This is useful to get a thicker sawtooth sound with more movement as different harmonics interfere with each other. To get a regular single sawtooth, set **PW** to mid position or either extreme value.

TRANSISTOR PULSE

Transistor pulse is special sort of pulse waveform, suitable when you want to achieve acid-like sounds. It sounds a bit more shrill compared to the regular pulse waveform available to the oscillators. **PW** sets the width of the upper and lower parts of the wave, just like on the regular pulse waveform described below. The major difference is that one part of the transistor pulse waveform is not flat, but rather sloping a bit, thus displaying a slightly similar form as a sawtooth waveform. This introduces more even harmonics, making the sound less hollow. Extreme **PW** settings, positive or negative, will mute the waveform as the upper or lower part disappears completely. A change in pitch also changes the waveform and pulse-width a bit, giving slightly different sound at different pitches.

PULSE

When the **PW** parameter is set to its middle value of 0, a square wave will be produced. A square wave contains only odd-numbered harmonics of the fundamental frequency and has a hollow sound, not quite as full as a sawtooth waveform. Changing the **PW** makes the pulse waveform asymmetric, introducing even harmonics and making the sound thinner and more nasal. Using **PWM** is the most classic way of adding animation to a synthesizer waveform. When you want to recreate the sounds of old video games, square waves are very handy. Extreme **PW** settings, positive or negative, will mute the waveform, as the upper or lower part disappears completely.

TRIANGLE

A triangle waveform has a mellow and dampened sound, reminiscent of a mix between a pure sine wave and a square wave. A triangle wave contains only odd-numbered harmonics, but at lower levels than a square wave. A low-pass filtered triangle wave will sound very much like a sine wave. The **PW** parameter introduces an edge in the waveform, gradually changing it from a pure triangle at mid position to a reversed sawtooth waveform at extreme **PW** settings.

14.1.1 SUB OSCILLATORS

Each oscillator features a sub oscillator, running at a fixed interval below the oscillator. By activating a sub oscillator, more depth and body will be added to the sound. The sub oscillators work as an extension of the regular oscillator pitch, but will however not be affected by neither waveshaping nor pulse width modulation. Four sub oscillator waveforms exist.

1OCT This option will add a square waveform one octave below the root note. The sub oscillator frequency is 1/2 of the oscillator frequency.

2OCT This option will add a square waveform two octaves below the root note. The sub oscillator frequency is 1/4 of the oscillator frequency.

2PUL This option will add a 25% pulse waveform two octaves below the root note. This selection sounds a bit similar to mixing the 1OCT and 2OCT types.

5TH This option adds a 33% pulse waveform one perfect fifth, which is equivalent to seven semitones, below the oscillator. The sub oscillator thus operates at 2/3 of the oscillator frequency. If for instance, the oscillator plays a G, then the sub oscillator will play the C below it. Together with the other oscillator, this makes it possible to play a simple chord using just one track of the Analog Four.



To get a C minor chord (C, Eb, G), set the oscillator TUN parameter to +7 semitones (for the G), set the sub oscillator to 5TH (for the C), and set the other oscillator to +3 semitones (for the minor third, Eb). To get a C major chord, set the other oscillator to +4 instead (for the major third, E). Suspended chords are created by setting TUN of the other oscillator to +5 (the perfect fourth, F) for a Csus4 chord, or to +2 (the major second, D) for a Csus2 chord. Moreover, four-note chords like the major 7th chord (maj7) and minor 7th chord (m7) are possible by using both oscillators' sub oscillators in 5TH modes, as these chords consist of two perfect fifths. With oscillator coarse tune settings of +7 and +11 semitones (G and B, respectively) the sub oscillators will be placed at C and E notes, forming a C major 7th (Cmaj7) chord. Tuning the oscillators to +7 and +10 semitones instead (G and Bb) the sub oscillators end up at C and Eb, forming a C minor 7th (Cm7) chord. The desired chord can be heard when the keyboard or the sequencer plays a C note. When playing other notes, the chord will transpose accordingly, enabling simple chord progressions. Transitions between the minor and major variants can be done on step basis in the sequencer by parameter locking the TUN parameter of the other oscillator to +3 or +4 where desired.

OFF This turns off the sub oscillator completely. Note that it is otherwise on, regardless of the regular oscillator waveform setting. The oscillator's LEV setting then determines the level of the oscillator and sub oscillator combined.

14.1.2 OTHER OSCILLATOR WAVEFORM SELECTIONS

IN L Will use audio coming from the left external input as the audio source instead of the oscillator waveforms. The incoming audio can then be affected by the AM, the filters, the overdrive and the amplitude envelope of the track.

IN R Equivalent to IN L, but using the right external input.

FDB This setting is only available to OSCILLATOR 1. Instead of using the oscillator waveform as the audio source, the audio coming from the ladder filter output will be used. Just as with the oscillator, the LEV parameter sets the level of this signal path. Turning it up high can introduce a self-oscillating feedback useful for drums or uncontrolled screams. The filter cutoff and resonance settings also affect the feedback behavior. On more moderate levels, it will give a more overloaded sound character to whatever enters the filter from OSC2, similar to the external feedback patch known from certain 1970s synths.

NEI This setting is only available in the OSCILLATOR 2 menu. It will route the audio of the multimode filter output of the track preceding the track being edited. This audio can then be affected by the AM, the filters, the overdrive and the amplitude envelope of the track. In this way track 1 can be sent to track 2, track 2 to track 3, track 3 to track 4. For a completely serial routing, turn down the LEV setting of the routed track completely. This setting does nothing on track 1.

OFF This will turn off the oscillator entirely. The sub oscillator is not affected though.



The AM functionality between the oscillators still exists when using filter feedback, neighbor, and external inputs as the OSC1/OSC2 waveforms. I.e., other signals than oscillator signals can be subject to amplitude modulation.

14.2 FILTERS

14.2.1 4-POLE LADDER FILTER

There is no way to turn the ladder filter completely off, but turning up the cutoff frequency will pass all frequencies through. It should be noted that zero resonance does not give the flattest frequency response – instead, it drops some decibels both in the treble and in the bass. The flattest response is reached when resonance is somewhere around 25, which is also the default value.

14.2.2 2-POLE MULTI MODE FILTER

There is no way to turn the multimode filter completely off, but if no filtering is desired there are a number of good ways to let all audio pass through unaffected by the filter:

- HP2 at min frequency, no resonance.
- BS at min frequency, no resonance.
- LP2 at max frequency, no resonance.
- PK at max frequency, no resonance.
- PK at min frequency, no resonance. Note: this gives an inverted signal.

LP2 This 12 dB/octave lowpass mode attenuates frequencies above the cutoff frequency with twelve decibels per octave, similarly to most other classic 2-pole VCFs. The amount of resonance determines how much the frequencies around the cutoff frequency will be boosted. The sound of this filter is cleaner than the ladder filter, and their different sonic characters are both worth trying out. If combined, they can add up to an extraordinarily steep 6-pole filter.

LP1 This unorthodox 6 dB/octave lowpass mode has a less steep attenuation slope above the cutoff frequency than the LP2 mode. More high-frequency content will thus be retained, making the filtering less aggressive. The slope is gentle like a 1-pole filter – which normally cannot have resonance – but works in essence like a 2-pole filter with a resonance peak. The amount of resonance determines how much the frequencies around the cutoff frequency will be boosted. The LP1 mode is useful for equalizer duties without resonance, or for adding a resonance with just a hint of lowpass softness.

BP The bandpass filter gradually attenuates frequencies above and below the cutoff frequency with a slope of 6 dB/octave. The resonance setting controls how much the frequencies around the cutoff frequency will be boosted. The bandpass filter is good for isolating a sound in the frequency spectrum, making it easier to blend with other sounds in a mix.

HP1 This unusual 6 dB/octave highpass filter attenuates frequencies below the cutoff frequency with a less steep slope than the HP2 mode. The amount of resonance determines how much the frequencies around the cutoff point will be boosted. Besides ordinary highpass filter effects, the HP1 mode without resonance is useful for removing some of the bass of a sound, which in turn is helpful when you want to avoid a muddy mix.

HP2 This is a classic 12 dB/octave highpass filter, attenuating frequencies below the cutoff frequency. The filter slope is steeper compared to the highpass 1 filter, thus filtering out more low-frequency content. The amount of resonance determines how much the frequencies around the cutoff point will be boosted. A highpass filter is suitable when creating lead sounds or hi-hats.

BS The band-stop filter, also known as a band-reject or notch filter, works as an inverted bandpass filter. Signals around the cutoff frequency will be attenuated the most, while frequencies above and below the cutoff frequency gradually will become less and less affected. The higher the resonance, the narrower the filter notch will be. This means that in contrast to the other filter modes, the effect of the resonance parameter is greatest at a low setting, giving a wider notch. This filter shape is useful for both basic equalizer duties and unique filter effects. For example: sweeping the cutoff frequency with an LFO gives a phaser-sounding filter effect. Controlling it with an envelope while at the same time using the ladder filter gives a more complex filter sound. Static filter settings can give a somewhat acoustic resonant quality to sounds, especially transient-heavy ones.

PK The peak filter passes all the sound, boosting frequencies around the cutoff frequency. The higher the resonance, the more they will be boosted. A peak filter comes in handy when you want to highlight a certain characteristic of a sound, by for example adding more low end or more mid end. It can be used either statically, as the peak of a parametric equalizer, or dynamically, controlled by for example an LFO or envelope.

14.3 ENVELOPES

The amplitude envelopes and the assignable envelopes offer 12 different shapes, consisting of six basic shapes each with two different triggering behaviors. The envelope shape graphics indicates how the envelope will affect the modulation destination. The left portion of the graphics shows how the envelope behaves when it is rising, i.e. the attack phase, and to the right the falling behavior is shown, i.e. decay and release. The rise and fall can each be either linear or exponential, useful in different applications as described below. A dot to the left of the visual representation of the envelope indicates that the envelope will restart from level zero each time it is triggered. Envelope shapes without a dot mean the envelope will start from the level it had when being triggered.

0–1 Linear attack and decay/release. An envelope shape suitable for controlling the filters if linear attack/decay/release sweeps are desired. When used as an amplitude envelope the decay and release phase appears to drop quicker towards the end, making it most useful for sounds that should fade out without a tail.

2–3 This can be considered the standard envelope shape. Decay and release fall quicker in the beginning of their phase, behaving more snappy and – just like acoustic sounds tend to do – leaving a tail instead of ending abruptly. This envelope shape is useful for creating distinct sounds, for example, kick drums and basses, but also lengthier sounds like pads.

4–5 Exponential attack, linear decay/release. This shape makes the envelope rise quicker and quicker. This envelope is suitable when for example creating sounds appearing to be played in reverse or for sounds requiring a sudden attack.

6–7 Exponential attack, exponential decay/release. Since our hearing perceives loudness exponentially, this shape is primarily useful as an amplitude envelope for very long sounds that are supposed to fade in and fade out at a very constant rate. When used as a filter envelope, very clicky, whip lash-like sounds can also be obtained by using this shape.

8–9 Full attack, linear decay/release. The envelope will immediately rise to the full envelope level and stay there for the whole attack phase. The ATK parameter sets the duration of this attack phase. The envelope shape is useful as amplitude envelope for certain percussive sounds that need a punch at full volume followed by a quick decay, or for other sounds that should contain a full body before being entering the decay phase.

10–11 Full attack, exponential decay/release. The envelope behaves like shape 8-9 mentioned above, but decay and release will fall in a more snappy fashion, ending with a tail. This makes it even more useful for percussive sounds.

15. SETUP EXAMPLES

The versatile Analog Four years to play with other machines. Whether it uses its ability to sequencer control and play other analog synths using CV, plays its part in a MIDI chain of machines or processes amplified incoming audio: the Analog Four gets along with other gear. Vintage or modern. Five examples are shown here.

15.1 ANALOG FOUR CONTROL OF AN EXTERNAL ANALOG SYNTHESIZER

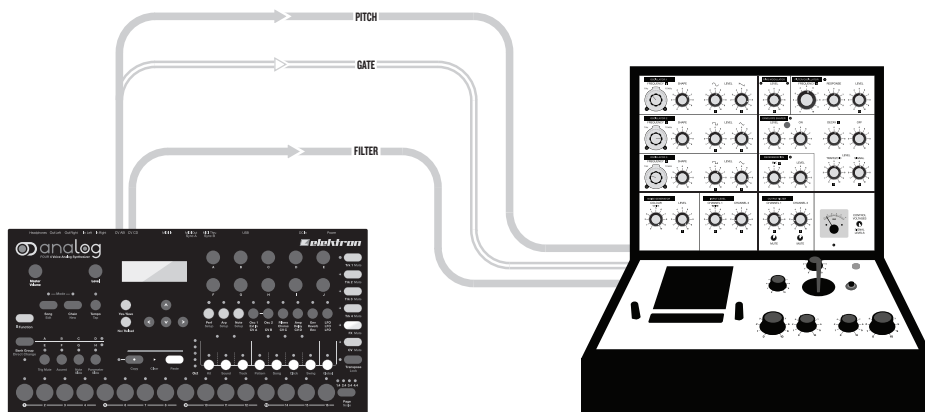

The CV/Gate track of the Analog Four is made for controlling external, CV/Gate equipped, analog gear. In this scenario, a vintage analog synthesizer is controlled by the Analog Four. The pitch and filter cutoff will be controlled.

1. Connect two standard insert/Y cables (or one Y cable and a standard mono phone cable) to the Analog Four CV AB and CV CD outputs.
2. Connect the tip cable of the CV AB insert cable to the external synth pitch CV control input. This cable will control the pitch of the external synth.
3. Connect the ring cable of the CV AB insert cable to the external synth gate input. This cable will open the envelope of the external synth.
4. Connect the tip cable of the CV CD insert/Y cable (or the mono phone cable) to the external synth filter CV input. This cable will control the filter cutoff of the external synth.
5. While on the CV track, press **[FUNCTION] + [CV A]**. In this menu, set TYPE to PITCH V/OCT. You can read more about how to calibrate the pitch CV so that it matches the tuning of your external CV-controlled synthesizer in the CV CONFIG menu. For more information, please see “12.6 CV CONFIG” on page 61.



6. Press **[FUNCTION] + [CV B]**. In this menu, set TYPE to GATE. Exit the menu.



7. Press **[FUNCTION] + [CV C]**. In this menu, set TYPE to VALUE LIN. Exit the menu.

	TYPE	VALUE	LIN
	HIN	+0.0 V	
	MAX	+5.0 V	

CVC CFG

8. The Analog Four is now ready to control the external synthesizer. On the CV A, CV B and CV C pages, the controllable parameters are indicated by arrows pointing from the parameters to the cable plug graphics. These parameters can, of course, be parameter locked.

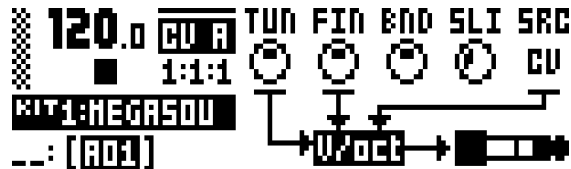

For controlling the pitch of for example old analog Korg or Yamaha gear, use the PITCH Hz/V. For CV pages containing TYPE selections of PITCH V/OCT, PITCH Hz/V, TRIG and GATE, the SRC parameter selects from which tracks note trigs will be derived. Pitch could for example be controlled from the CV track while gate signals could be controlled from the FX track. When setting another track as the SRC selection, the arpeggiator of that track can be used as well to send note trigs.

15.2 ANALOG FOUR WITH OTHER ELEKTRON GEAR

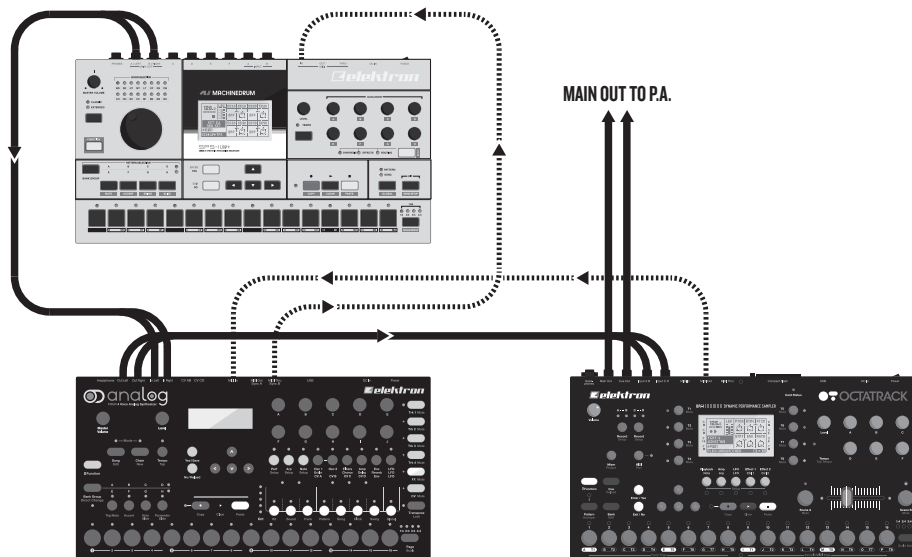

The Analog Four thrives with other Elektron gear. In this example, it is used with an Octatrack and a Machinedrum. The Machinedrum main output is connected to the Analog Four inputs. The Analog Four main output is connected to one of the input pairs of the Octatrack. The main outputs of the Octatrack go to the PA. The Machinedrum and Analog Four are MIDI slaved to the Octatrack.

The Machinedrum creates the beats. The Analog Four is responsible for basses and synth sounds. The Octatrack plays back loops and can also be used to sample the audio from the Analog Four plus Machinedrum.

Because the Machinedrum is connected to the Analog Four inputs, the internal effects of the Analog Four can be used to affect the incoming signal. This can be used to add sudden washes of reverb or delay to the beat.

1. Press the fifth [TRACK] key, the FX track, on the Analog Four. Select the EXT IN page.
2. Turn up the volume on both channels to 100.



3. Make a performance macro controlling the CHO, DEL and REV parameters, located on the EXT IN page of the FX track, for both the left and right channel. For more information, please see "9.3.1 PERFORMANCE SETUP" on page 27.

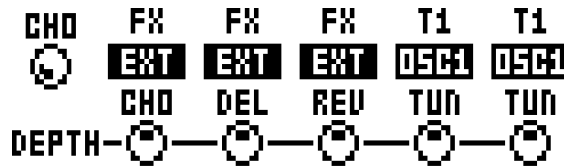

15.3 ANALOG FOUR AS A FILTER BANK

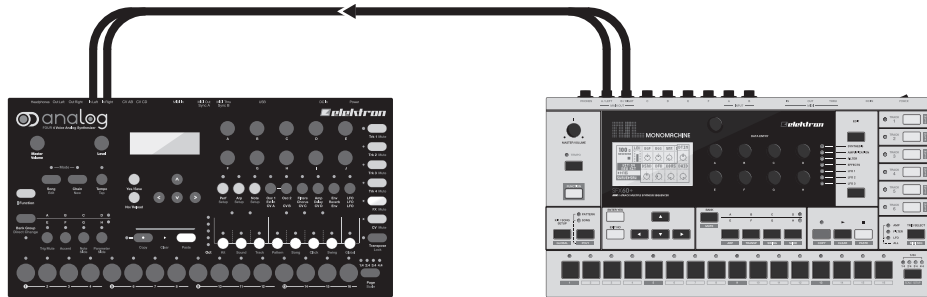

Thanks to the neighbor routing, all the filters of the Analog Four can be used for providing an immense mono filter bank consisting of 8 filters plus 4 overdrive circuits. The setup can be either serial or parallel. It can, of course, be set up for stereo filtering as well. In this scenario, 4 filters are available for the left and right channels.

In this example, the two filters of each track will be used in parallel with the filters of the other tracks.

1. Connect the outputs of for example a Monomachine to the inputs of the Analog Four.
2. For all four synth tracks, set the WAV parameter in the OSC1 page to IN R, and the WAV parameter of OSC2 to IN L. This will sum the left and right channels.

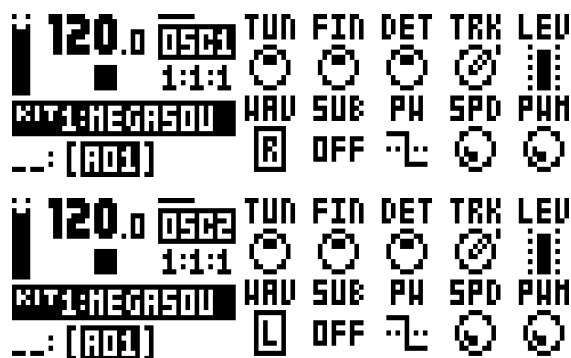

3. Set all other WAV parameters to OFF. Make sure all SUB parameters is set to OFF as well.
4. On the AMP page for all tracks, make sure ATK is 0, DEC 0, SUS 127 and REL INF.

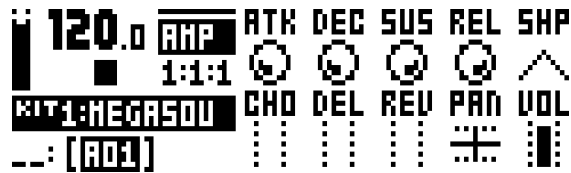

- On the FILTER page for all tracks, the DEP parameters should be set to 0.

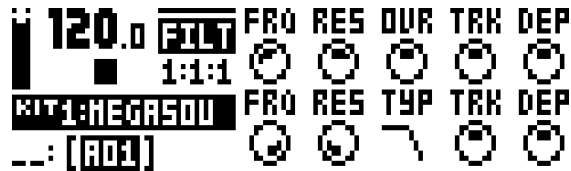

- Place note trigs on the first step of the sequencer. Triggering the amplitude envelope is necessary.
- Press play on the Monomachine.
- Press play on the Analog Four. The filters of the synth tracks can now be used to shape the incoming Monomachine sound.



For serial filtering, make either one or both oscillators of synth track 1 listen to the external inputs. Set the WAV parameter of oscillator 2 to NEI on the other tracks. Turn off oscillator 1 on tracks 2-4. Turn down the track level to 0 for tracks 1-3.

Make the Analog Four listen to MIDI clock and transport controls sent from the Monomachine. When pressing play on the Monomachine sequencer, both units will start to play at the same time and in the same BPM. Experiment with the tempo-synced LFOs of the Analog Four controlling the filter parameters.

Place other note trigs on the Analog Four sequencer and experiment with the filter envelope settings.

When using the Analog Four as a stereo filter, let track 1-2 take care of the left signal and track 3-4 take care of the right. Don't forget to pan the synth tracks responsible for the left and right channels hard left and right. If you wish to control the FRQ or RES parameters of the left and right tracks simultaneously, you can use a performance macro.

15.4 USING AN EXTERNAL OSCILLATOR WITH THE ANALOG FOUR

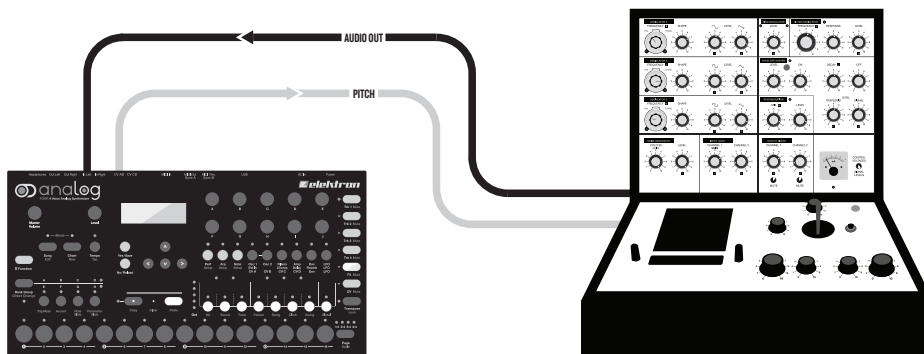

The CV/Gate outputs and the external inputs allow an external oscillator to be used with the internal Analog Four oscillators. Use this trick when you want a different (perhaps old, quirky and unpredictable yet charming) oscillator to provide the fundamental tone but still want the control and modulation power of the Analog Four.

In this setup example, the CV track will trig the oscillator of an external analog synth. The output of this oscillator will be routed to the left input of the Analog Four. Synth track 1 of the Analog Four will control the pitch of both the internal oscillators and the external oscillator. The filters and envelopes of track 1 will shape both the internal and the external oscillators.

- Connect a standard mono phone (or insert/Y) cable to the Analog Four CV AB output.
- Connect the output of the external oscillator to the left external input

3. Connect the mono phone (or tip of the insert/Y) cable from CV AB to the pitch CV control input of the external synth.
4. Select the CV track and press [FUNCTION] + [CV A]. In this menu, depending on the specification of the external analog synth, set TYPE to either PITCH V/OCT or PITCH Hz/V. You can read more about how to calibrate the pitch CV so that it matches the tuning of your external CV-controlled synthesizer in the CV CONFIG section. For more information, please see “12.6 CV CONFIG” on page 61.



5. Set the SRC parameter of the CV A page to TR1. This will make the CV track send out pitch voltages according to the note trigs on synth track 1.

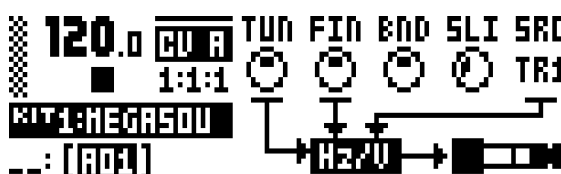

6. Select track 1. Set WAV on the OSC1 page to IN L. For oscillator 2, choose one of the internal Analog Four waveforms.



7. Note trigs placed on track 1 will now control both the internal and the external oscillators.



Use parameter locks to alternate the waveform of oscillator 1 between external/internal selections.

This example can use more than one external oscillator. If two separate external oscillators are connected to the Analog Four external inputs, both oscillators can be used on for example track 1. Track 2-4 could then use only internal oscillators.

15.5 ANALOG FOUR WITH AN ELECTRIC GUITAR

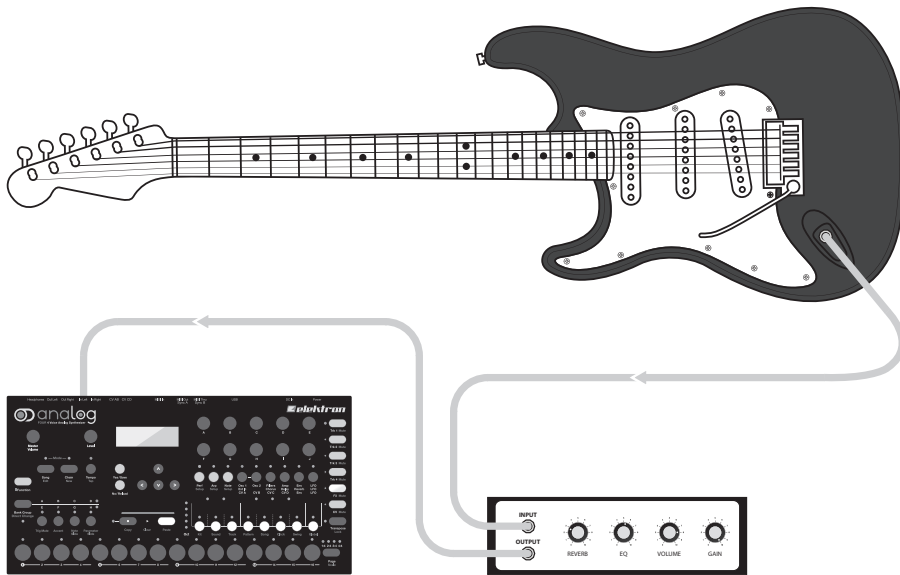

In this setup example, the Analog Four is used for processing the sound output from an electric guitar. The first, most basic method uses the FX track to turn the Analog Four into an effects box sporting the Wideshift Chorus, Saturator Delay, and Supervoid Reverb effects. The second, more elaborate method routes the sound through Track 1 and allows all the sound-shaping possibilities offered by the FILTERS, AMP, ENV and LFO.

1. Connect the electric guitar to the audio input of an amplifier using a standard mono phone cable.
2. Connect the audio out from the amplifier to the left audio input of the Analog Four.
3. First method: Select the FX track on the Analog Four with [TRACK] key 5. To make use of the Wideshift Chorus, press [PARAMETER] key 3, CHORUS. Change the volume and other aspects of the effect using the **DATA ENTRY** knobs. Use Saturator Delay and Supervoid Reverb effects similarly by pressing [PARAMETER] key 4, DELAY and key 5, REVERB respectively.

```

120.0 CHOR  PRE SPD DEP WID FDB
      1:1:1  [K] [K] [K] [K] [K]
WAV1:MEGRASOU HPF LPF DEL REV VOL
--: [A01]  [K] [K] [K] [K] [K]
  
```

4. Second method: Select Track 1 on the Analog Four by pressing [TRACK 1] key.
5. On the OSC1 menu page, set the WAV parameter to IN L using **DATA ENTRY** knob F. Set SUB, the sub oscillator, to off. Turn LEV all the way up.

```

120.0 OSC1  TUN FIN DET TRX LEV
      1:1:1  [K] [K] [K] [K] [K]
WAV1:MEGRASOU WAV SUB PH SPD PHH
--: [A01]  [K] OFF [K] [K] [K]
  
```

6. Make a custom set of filtering, amplifier, envelope and LFO processing of the sound feed from the electric guitar by setting the values of your choice on the corresponding parameter menu page, [PARAMETER] key 3-6. Remember to set the VOL to a high value on the AMP page.

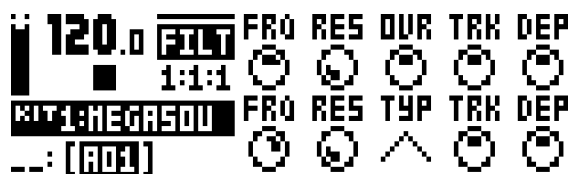

7. Place a note trig on the first step of the sequencer for Track 1. This is required to start the envelope processing of the feed from the electric guitar.
8. Press play on the Analog Four.



The three main send effects are a perfect choice when performing at large arenas. Let your sounds expand in all dimensions of the time-space continuum with the Wideshift Chorus, Saturator Delay, and Supervoid Reverb!

Experiment with different filter and LFO settings when sending the guitar feed through one of the synth tracks, as outlined in the second method above. Try setting the second filter type (TYP) to BP or HP on the FILTERS page at mid- to high cutoff frequency (FRQ). Then, experiment with high low-frequency oscillation speeds (SPD) and different distortion settings (DST) on the LFO page to produce wildly flanging or cool robotic phaser effects.

16. USEFUL KEY COMBINATIONS (QUICK KEYS)

Use the key combinations below in order to quickly perform certain tasks.

16.1 GENERAL

[FUNCTION] + [RECORD] will perform a copy command. Action depends on the currently active page or mode.

[FUNCTION] + [PLAY] will perform a clear command. Action depends on the currently active page or mode.

[FUNCTION] + [STOP] will perform a paste command. Action depends on the content that was copied.

16.2 NAMING

[FUNCTION] + [ARROW] (on the NAMING screen) to choose a letter.

[FUNCTION] + [NO/RELOAD] (on the NAMING screen) to erase a letter.

16.3 SOUND BROWSER

Double-tap a [TRACK] key to quickly access the SOUND BROWSER.

Use [ARROW] keys to browse. Press [YES/SAVE] to load the sound to the track.

16.4 SAVING AND RELOADING

[YES/SAVE] + [KEYBOARD C1] (KIT) will save Kit.

[NO/RELOAD] + [KEYBOARD C1] (KIT) will reload Kit.

[YES/SAVE] + [KEYBOARD D1] (SOUND) to save Sound.

[NO/RELOAD] + [KEYBOARD D1] (SOUND) will reload Sound.

[YES/SAVE] + [KEYBOARD E1] (TRACK) will save Track.

[NO/RELOAD] + [KEYBOARD E1] (TRACK) will reload Track.

[YES/SAVE] + [KEYBOARD F1] (PATTERN) will save Pattern.

[NO/RELOAD] + [KEYBOARD F1] (PATTERN) will reload Pattern.

[YES/SAVE] + [KEYBOARD G1] (SONG) will save Song.

[NO/RELOAD] + [KEYBOARD G1] (SONG) will reload Song.

16.5 MENU ACCESS

[FUNCTION] + [KEYBOARD C2] (GLOBAL) to open the GLOBAL menu.

[FUNCTION] + [KEYBOARD C1] (KIT) to open the KIT menu.

[FUNCTION] + [KEYBOARD D1] to open the SOUND menu.

16.6 SEQUENCER SETTINGS

[FUNCTION] + [TEMPO] to tap tempo.

[FUNCTION] + [KEYBOARD A1] (CLICK) to access the CLICK settings.

[FUNCTION] + [NOTE] to access the QUANTIZE settings for the active track.

[FUNCTION] + [PAGE] to access the pattern / track SCALE settings. Increase pattern length by 16 steps a pop by pressing [PAGE] repeatedly.

16.7 MUTES

[FUNCTION] + [TRACK] will mute/unmute one or several Tracks.

SEQUENCER RECORDING

[RECORD] + [PLAY] to start LIVE RECORDING.

[RECORD] + double-tap [PLAY] will activate/deactivate QUANTIZE LIVE RECORDING.

16.8 CLEAR TRACK / CLEAR PATTERN

[FUNCTION] + [PLAY] (while in GRID RECORDING mode) to clear active Track.

[FUNCTION] + [PLAY] (while in no mode or LIVE RECORDING mode) to clear Pattern.

16.9 SHIFTING TRIGS AROUND

[FUNCTION] + [LEFT/RIGHT] to move all trigs a whole step, left or right.

[TRIG] + [LEFT/RIGHT] to nudge a single trig a fractional step left or right.

16.10 CHAIN EDITING

[FUNCTION] + [CHAIN] to create new scratch pad row.

[CHAIN] + [LEFT/RIGHT] to move chain cursor.

[CHAIN] + [NO/RELOAD] to remove Pattern from the chain before cursor (or selected).

[BANK X/X] + [TRIG] to enter a new Pattern into the chain (positioned where the cursor is at).

16.11 RANDOMIZE PARAMETERS

Press [PARAMETER] key + [YES] to randomize that parameters on that page.

Press [PARAMETER] key + [NO] to reset the PARAMETER page to its last saved state.

17. TECHNICAL INFORMATION

THE SEQUENCER

4 synth tracks
 1 FX track
 1 CV/Gate track
 128 projects (+Drive)
 4096 sounds (+Drive Sound library)
 128 patterns (per project)
 Up to 64 steps per pattern
 128 Sounds (per project)
 128 Kits (per project)
 16 Songs (per project)
 6 × arpeggiators
 Individual track lengths
 Swing, slide and accent functions
 Track transpose
 Micro timing
 Parameter locks
 Live friendly Performance mode
 Sound-per-step change
 Instant kit, pattern, track and Sound reload
 Full real-time control

SEND EFFECTS

Wideshift Chorus
 Saturator Delay
 Supervoid Reverb

SYNTH VOICE x4

Fully analog signal path
 2 × analog oscillators
 Variable waveshape on all waveforms
 Oscillator AM and Sync modes
 2 × sub-oscillators
 1 × noise generator
 1 × 4-pole analog lowpass ladder filter
 1 × 2-pole analog multi-mode filter
 1 × analog overdrive circuit
 Filter feedback
 2 × assignable LFOs
 1 × dedicated vibrato LFO
 2 × dedicated waveshape LFOs
 1 × amp envelope
 2 × assignable envelopes
 2 × dedicated LFO fade envelopes
 1 × dedicated noise fade envelope
 1 × dedicated vibrato envelope
 1 × dedicated autobend envelope
 3 × individual effect sends
 MIDI control

FEATURES

Up to 4-Note Polyphony/Multitimbral/Unison
 +Drive enables multiple (x128) projects

ELECTRICAL SPECIFICATIONS

Impedance balanced audio outputs:

Headphones out level: +19 dBu (55 Ω)
 Main outputs level: +19 dBu
 Output impedance: 440 Ω unbalanced

Unbalanced audio inputs:

Input level: +19 dBu maximum
 Audio input impedance: 9 kΩ

Digital S/N ratio: 102 dBFS (20–20,000 Hz)
 Unit power consumption: 8 W typical, 18 W maximum.
 Recommended power supply: PSU-3/b/c,
 12 V DC, 2 A

HARDWARE

122 × 32 pixel backlit LCD
 MIDI In/Out/Thru with DIN Sync out
 2 × 1/4" impedance balanced audio out jacks
 2 × 1/4" audio in jacks
 1 × 1/4" stereo headphone jack
 2 × 1/4" dual CV/Gate outputs
 48 kHz, 24-bit D/A and A/D converters
 Flash-EEPROM upgradable OS
 Electrically isolated USB 2.0 port

PHYSICAL SPECIFICATIONS

Steel casing
 Dimensions: W340 × D176 × H63mm
 (including knobs, jacks and feet)
 Weight: approximately 2.4 kg

POWER SUPPLY ELECTRICAL SPECIFICATIONS

Input voltage range: 100–240 V (43–60Hz)
 Input connector: IEC320-C8 (2 prong)
 In-rush current: 40–60 A maximum
 Output voltage: 12 V DC
 Output current: 2.5 A maximum
 Output connector: 5.5 × 2.5 mm DC plug, power at center

18. CREDITS AND CONTACT INFORMATION

CREDITS

PRODUCT DESIGN AND DEVELOPMENT

Oscar Albinsson
Magnus Forsell
Anders Gärder
Jimmy Myhrman
Jon Mårtensson
David Revelj
Mattias Rickardsson
Daniel Troberg

ADDITIONAL DESIGN

Thomas Ekelund

FACTORY DEFAULT SOUND DESIGN

Daren Ager
Richard Devine
Nicholas Lem
Simon Mattisson
Jimmy Myhrman
Jon Mårtensson
Cenk Sayinli
Alex Schetter
Charlie Storm
Daniel Troberg

DOCUMENTATION

Ufuk Demir
Thomas Ekelund
Jon Mårtensson
Daniel Sterner
Erik Ångman

CONTACT INFORMATION

ELEKTRON WEBSITE

<http://www.elektron.se>

OFFICE ADDRESS

Elektron Music Machines MAV AB
Banehagsliden 5
SE-414 51 Gothenburg
Sweden

APPENDIX A: SYNTH TRACK PARAMETERS

In this appendix, the parameters of the synth tracks are explained.



- You can also randomize the parameter settings on a specific **PARAMETER** page of a track. Press **[PARAMETER]** key + **[YES]** to randomize all parameters on that page. Every time you press this key combination, the parameters randomize in a new way.
- Press **[PARAMETER]** key + **[NO]** to reset the **PARAMETER** page to its last saved state.
- The parameters on the **ARP** page and **NOTE** menu can not be randomized.

OSCILLATOR 1

The **OSC1** pages control the first oscillator, its sub oscillator, plus the noise generator.

OSC 1 (page 1)

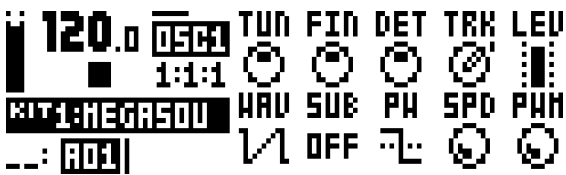

TUN (OSC1 Coarse Tune) sets the pitch of the oscillator in semi-tones. Press and hold **[FUNCTION]** and then turn the knob to jump a whole octave. Press the knob while turning it to jump four semi-tones.

FIN (OSC1 Fine Tune) fine tunes the pitch of the oscillator. This knob can be continuously tweaked several turns. **TUN** is increased or decreased one semitone for every turn on **FIN**.

DET (OSC1 Linear Detune) offsets the frequency of the oscillator by a certain number of hertz (unlike **FIN**, which adjusts the pitch in cents). This unique feature gives more detune in the bass notes and allows for a different kind of chorus-like detune that reminds of very old and big analog synthesizers.

TRK (OSC1 Keytrack) sets the oscillator pitch to follow the notes you play or not. When off, the pitch is constant, which can be convenient for drum or effects sounds.

LEV (OSC1 Level) sets the oscillator level. The normal level is 100. The sound can get dirtier at higher levels; lower levels gives a cleaner signal through the filters and also makes filter resonances more pronounced. Try different levels for different kinds of sounds.

WAV (OSC1 Waveform) sets the oscillator waveform to Sawtooth, Transistor Pulse, Pulse, or Triangle. It is also possible to choose one of the two External Inputs (to send external sounds through the filters) or to activate Filter Feedback. Note that selecting a waveform does not change the **PW** parameter, which affects the waveshape of the chosen waveform.

SUB (OSC1 Sub Oscillator) sets the waveform of the sub oscillator or turns it off. The sub oscillator pitch is fixed at one or two octaves below the oscillator.

PW (OSC1 Pulsewidth) sets the oscillator waveshape. The mid position (64) gives the default waveshape. Unlike on most synths, all four waveforms, selected by **WAV**, have variable waveshapes.

SPD (OSC1 PWM Speed) sets the speed of the oscillator's PWM LFO, which can be used to modulate the waveshape back and forth around the set **PW** parameter.

PWM (OSC1 PWM Depth) sets the amount of the oscillator's Pulsewidth Modulation around the set **PW** parameter. Use this to add subtle or drastic motion to the sound.

NOISE (page 2)

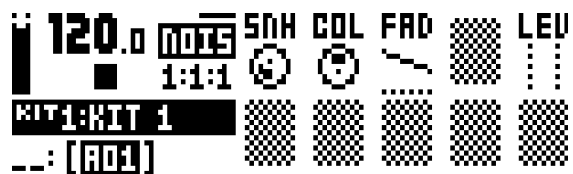

S&H (Sample & Hold) sets the tuning of the noise spectrum.

COL (Color) sets a filter that changes the frequency content of the noise oscillator. Negative values render lowpass-filtered noise. For example, a setting of -64 is red (-6dB/oct) and -32 is pink (-3dB/oct) noise. Positive values render highpass-filtered noise. A setting of zero disables the filter, making the output white noise.

FAD (Noise Fade) sets the fade-in or fade-out of the noise. The mid position (0) gives a constant noise output. Positive values give a fade-out, negative values give a fade-in. The graphics will illustrate the slope of the fade, across the spectrum, as you tweak the encoder.

LEV (Noise Level) sets the level of noise.

OSCILLATOR 2

The OSC2 pages control the second oscillator and the accompanying sub oscillator. Settings that will affect both oscillators are found here as well.

OSC 2 (page 1)

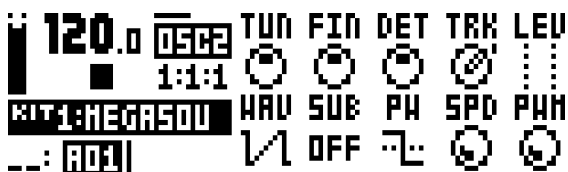

TUN (OSC2 Coarse Tune) sets the pitch of the oscillator in semitones. Press and hold [FUNCTION] and then turn the knob to jump a whole octave.

FIN (OSC2 Fine Tune) fine tunes the pitch of the oscillator. This knob can be continuously tweaked several turns. TUN is increased or decreased one semitone for every turn on FIN.

DET (OSC2 Linear Detune) offsets the frequency of the oscillator by a certain number of hertz (unlike FIN, which adjusts the pitch in cents). This unique feature gives more detune in the bass notes and allows for a different kind of chorus-like detune that reminds of very old and big analog synthesizers.

TRK (OSC2 Keytrack) sets the oscillator pitch to follow the notes you play or not. When off, the pitch is constant, which can be convenient for drum or effects sounds.

LEV (OSC2 Level) sets the oscillator level. The normal level is 100. The sound can get dirtier at higher levels; lower levels gives a cleaner signal through the filters and also makes filter resonances more pronounced. Try different levels for different kinds of sounds.

WAV (OSC2 Waveform) sets the oscillator waveform to Sawtooth, Transistor Pulse, Pulse, or Triangle. It is also possible to choose one of the two External Inputs (to send external sounds through the filters) or to activate Neighbor, which will route the audio of the previous track to the currently active track. Note that selecting a waveform does not change the PW parameter, which affects the waveshape of the chosen waveform.

SUB (OSC2 Sub Oscillator) sets the waveform of the sub oscillator or turns it off. The sub oscillator pitch is fixed at one or two octaves below the oscillator.

PW (OSC2 Pulsewidth) sets the oscillator waveshape. The mid position (64) gives the default waveshape. Unlike on most synths, all four waveforms, selected by WAV, have variable waveshapes.

SPD (OSC2 PWM Speed) sets the speed of the oscillator's PWM LFO, which can be used to modulate the waveshape back and forth around the set PW parameter.

PWM (OSC2 PWM Depth) sets the amount of the oscillator's Pulsewidth Modulation around the set PW parameter. Use this to add subtle or drastic motion to the sound.

OSC 2 (page 2)

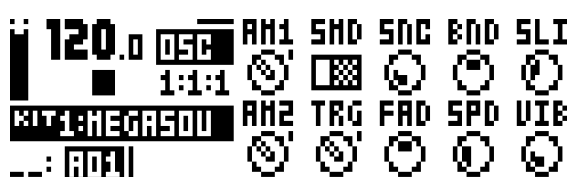

AM1 (Osc1 AM) engages Amplitude Modulation on Oscillator 1, which means that its signal is switched on/off (multiplied) by the pulse wave of Oscillator 2. This introduces new harmonics with frequencies being the sum and difference frequencies of the harmonics of the two oscillators. The result is related to ring modulation and can give metallic, hollow, or disharmonic sound qualities. Note that the waveform and pulse width of Oscillator 2 also affects the result, even if that oscillator is not heard.

SMD (Sync Mode) enables oscillator sync between the two oscillators, either Osc2 synchronized to Osc1, Osc1 to Osc2, or Metal Sync where both oscillators reset each other in a special manner.

SNC (Sync Amount) sets the amount or "hardness" of the oscillator sync, meaning how hard the synced oscillator will lock to the syncing oscillator's frequency. Maximum value gives so-called "hard sync" with the strongest sync sound. Lower values give "soft sync" where the synced oscillator can also lock to subharmonics of the syncing oscillator. The value zero gives no sync at all.

BND (Bend Depth) sets the amount of auto bend. The higher the setting, the more the pitch of a triggered note will be offset. The sound will then glide towards its right pitch. This parameter is particularly useful in drum sounds or sync sweeps; if oscillator sync is engaged (SMD) then only the synced oscillator will bend.

SLI (Note Slide time) sets the slide time of note slides, set in the NOTE SLIDE menu, and also the auto bend time (BND).

AM2 (Osc2 AM) engages Amplitude Modulation on Oscillator 2, which means that its signal is switched on/off (multiplied) by the pulse wave of Oscillator 1. See AM1 above.

TRG (Oscillator Retrig) lets the two oscillators start each note in phase with each other. This can give a stronger and more consistent bass punch thanks to constructive interference, and can also change the sound character in other ways.

FAD (Vibrato Fade) sets the fade-in or fade-out of the vibrato. The mid position (0) gives a constant vibrato. Positive values give a fade-out, negative values give a fade-in.

SPD (Vibrato Speed) sets the frequency of the vibrato LFO affecting both oscillators.

VIB (Vibrato Depth) sets the amount of vibrato.

FILTERS

In the FILTERS page, settings that will affect the two track filters are found.

FILTERS

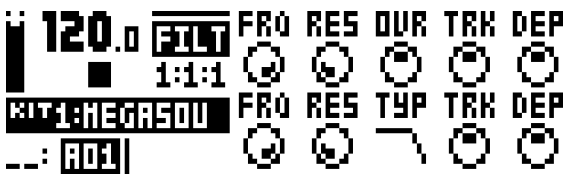

DEP (Filter2 EnvF Depth) sets the amount of cutoff frequency modulation from the filter envelope EnvF. The knob is bipolar (both negative and positive modulation depth is possible). Note that this parameter always affects Filter2, regardless of which modulation destinations are chosen.

FRQ (Filter1 Frequency) sets the cutoff frequency of Filter 1, the 4-pole lowpass transistor ladder filter.

RES (Filter1 Resonance) sets the resonance of Filter 1. Increased resonance introduces a peak in the spectrum at the cutoff frequency. By design, Filter 1 has a stronger resonance in the higher frequencies, which gives a characteristic electronic filter sound when the resonance starts sharp and then falls during a falling filter envelope.

OVR (Filter1 Overdrive) introduces distortion in the signal path. In mid position (0) the signal is kept clean. Increasing positive values gives a clipping distortion after Filter 1. Increasing negative values also distorts the signal, but with a softer overdrive inside the filter.

TRK (Filter1 Keytrack) lets the cutoff frequency follow the pitch of the sound. A setting of 32 will make the filter track the oscillator frequency in note intervals, making it possible to play the Filter 1 resonance the same way as an oscillator is played.

DEP (Filter1 EnvF Depth) sets the amount of cutoff frequency modulation from the filter envelope EnvF. The knob is bipolar (both negative and positive modulation depth is possible). Note that this parameter always affects Filter1, regardless of which modulation destinations are chosen.

FRQ (Filter2 Frequency) sets the cutoff frequency of Filter 2, which is the 2-pole multimode filter located after Filter 1 and Overdrive.

RES (Filter2 Resonance) sets the resonance of Filter 2. Increased resonance introduces a peak in the spectrum at the cutoff frequency. (Except for the Bandstop filter type, which has a notch instead of a peak. This notch is widest at the lowest Resonance setting.) Compared to Filter 1, Filter 2 has a more uniform resonance behavior over the whole audio spectrum.

TYP (Filter2 Type) selects the filter type of Filter 2. Seven types are available: 2-pole Lowpass, 1-pole Lowpass, Bandpass, 1-pole Highpass, 2-pole Highpass, Bandstop, and Peak. Technically all of them are 2-pole filters with resonance, but the “1-pole” types have a flatter spectrum like simple 1-pole filters and can be very useful also for equalizer duties.

TRK (Filter2 Keytrack) lets the cutoff frequency follow the pitch of the sound. A setting of 32 will make the filter track the oscillator frequency in note intervals.

AMPLITUDE

The AMP page contains settings for the amplitude envelope and the effects sends, as well as panning and volume of the sound.

AMP



ATK (EnvA Attack) sets the attack time of the EnvA envelope, which controls the amplitude of the track.

DEC (EnvA Decay) sets the decay time of the EnvA envelope.

SUS (EnvA Sustain) sets the sustain level of the EnvA envelope.

REL (EnvA Release) sets the release time of the EnvA envelope.

SHP (EnvA Shape) sets the general shape of the EnvA envelope. Several linear and exponential shapes are available. A dot to the left of the visual representation of the envelope indicates that the envelope will restart from level zero. In other cases, it will start from the level it had when being triggered.

CHO (Chorus Send) sets the amount of synth track signal to send through to the Wideshift Chorus effect.

DEL (Delay Send) sets the amount of synth track signal to send through to the Saturator Delay effect.

REV (Reverb Send) sets the amount of synth track signal to send through to the Supervoid Reverb effect.

PAN (Pan) positions the Sound of the synth track in the stereo field.

VOL (Volume) sets the volume of the Sound. This parameter is independent of the LEV parameter.

ENVELOPES

Here parameters controlling the two assignable envelopes are found. The first envelope, ENVF, is hard-linked to the cutoff parameters of the two filters but can also modulate two user-selectable destinations.

ENVF (page 1)



ATK (EnvF Attack) sets the attack time of the EnvF envelope.

DEC (EnvF Decay) sets the decay time of the EnvF envelope.

SUS (EnvF Sustain) sets the sustain level of the EnvF envelope.

REL (EnvF Release) sets the release time of the EnvF envelope.

SHP (EnvF Shape) sets the general shape of the EnvF envelope. Several linear and exponential shapes are available. A dot to the left of the visual representation of the envelope indicates that the envelope will restart from level zero. In other cases, it will start from the level it had when being triggered.

LEN (EnvF Gate length) makes it possible to set a different gate length independent of the chosen Note length. The parameter value is directly related to the number of sequencer steps.

DST (EnvF Destination A) selects the first of the two assignable destinations for the EnvF envelope. Confirm a selection by pressing **[YES/SAVE]**.

DEP (EnvF Depth A) sets how much the envelope will modulate the destination chosen by the first DST parameter. The knob is bipolar (both negative and positive modulation depth is possible).

DST (EnvF Destination B) selects the second of the two assignable destinations for the EnvF envelope. Confirm a selection by pressing **[YES/SAVE]**.

DEP (EnvF Depth B) sets how much the envelope will modulate the destination chosen by the second DST parameter. The knob is bipolar (both negative and positive modulation depth is possible).

ENV2 (page 2)



ATK (Env2 Attack) sets the attack time of the Env2 envelope.

DEC (Env2 Decay) sets the decay time of the Env2 envelope.

SUS (Env2 Sustain) sets the sustain level of the Env2 envelope.

REL (Env2 Release) sets the release time of the Env2 envelope.

SHP (Env2 Shape) sets the general shape of the Env2 envelope. Several linear and exponential shapes are available. A dot to the left of the visual representation of the envelope indicates that the envelope will restart from level zero. In other cases, it will start from the level it had when being triggered.

LEN (Env2 Gate length) makes it possible to set a different gate length independent of the chosen Note length. The parameter value is directly related to the number of sequencer steps.

DST (Env2 Destination A) selects the first of the two available destinations for the Env2 envelope. Confirm a selection by pressing **[YES/SAVE]**.

DEP (Env2 Depth A) sets how much the envelope will modulate the destination chosen by the first DST parameter. The knob is bipolar (both negative and positive modulation depth is possible).

DST (Env2 Destination B) selects the second of the two available destinations for the Env2 envelope. Confirm a selection by pressing **[YES/SAVE]**.

DEP (Env2 Depth B) sets how much the envelope will modulate the destination chosen by the second DST parameter. The knob is bipolar (both negative and positive modulation depth is possible).

LFO

The two track LFOs can be used to modulate the other synth track parameters.

LFO1 (page 1)



SPD (LFO1 Speed) sets the speed of LFO1. It is synced to the BPM. For LFO1 to be synced to straight beats, try settings of 16, 32 or 64. The value is bi-polar (the LFO shape can be played backward by using negative values).

MUL (LFO1 Multiplier) multiplies the SPD parameter by the set factor. (x) multiplies the current tempo, (dot) syncs the LFO to 120 BPM regardless of the tempo, and (tuning fork) syncs the LFO to OSC1.

FAD (LFO1 Fade In/Out) offers the possibility to fade in/out the LFO modulation. Positive values give a fade-out, negative values give a fade-in. A mid position (0) will result in no fade in/out.

SPH (LFO1 Start Phase) sets where in the waveform the LFO1 will start when being triggered.

MOD (LFO1 Trig Mode) sets how the LFO1 will react when a note is played. There are five settings:

- FRE is the default free-running mode. It makes LFO1 run continuously, never restarting or stopping.
- TRG makes LFO1 restart when a note is played.
- HLD makes LFO1 run free in the background, but when a note is played the output LFO1 level is latched and held still until the next note is played.
- ONE The LFO1 starts when a note is triggered, then runs to the end of the waveform and then stops. This makes the LFO function similar to an envelope.
- HLF The LFO1 starts when a note is triggered, then runs to the middle of the waveform and then stops.

WAV (LFO1 Waveform) sets the LFO1 waveform.

DST (LFO1 Destination A) selects the first of the two available destinations for LFO1. Confirm a selection by pressing [YES/SAVE].

DEP (LFO1 Depth A) sets how much LFO1 will modulate the destination chosen by the first DST parameter. The knob is bipolar (both negative and positive modulation depth is possible).

DST (LFO1 Destination B) selects the second of the two available destinations for LFO1. Confirm a selection by pressing [YES/SAVE].

DEP (LFO1 Depth B) sets how much the LFO1 will modulate the destination chosen by the second DST parameter. The knob is bipolar (both negative and positive modulation depth is possible).

LFO2 (page 2)



SPD (LFO2 Speed) sets the speed of LFO2. It is synced to the BPM. For LFO2 to be synced to straight beats, try settings of 16, 32 or 64. The value is bi-polar (the LFO shape can be played backward by using negative values).

MUL (LFO2 Multiplier) multiplies the SPD parameter by the set factor. (x) multiplies the current tempo, (dot) syncs the LFO to 120 BPM regardless of the tempo, and (tuning fork) syncs the LFO to OSC2.

FAD (LFO2 Fade In/Out) offers the possibility to fade in/out the LFO modulation. Positive values give a fade-out, negative values give a fade-in. A mid position (0) will result in no fade in/out.

SPH (LFO2 Start Phase) sets where in the waveform the LFO2 will start when being triggered.

MOD (LFO2 Trig Mode) sets how the LFO2 will react when a note is played. There are five settings:

- FRE is the default free-running mode. It makes LFO2 run continuously, never restarting or stopping.
- TRG makes LFO2 restart when a note is played.
- HLD makes LFO2 run free in the background, but when a note is played the output LFO2 level is latched and held still until the next note is played.
- ONE The LFO2 starts when a note is triggered, then runs to the end of the waveform and then stops. This makes the LFO function similar to an envelope.
- HLF The LFO2 starts when a note is triggered, then runs to the middle of the waveform and then stops.

WAV (LFO2 Waveform) sets the LFO2 waveform.

DST (LFO2 Destination A) selects the first of the two available destinations for LFO2. Confirm a selection by pressing [YES/SAVE].

DEP (LFO2 Depth A) sets how much LFO2 will modulate the destination chosen by the first DST parameter. The knob is bipolar (both negative and positive modulation depth is possible).

DST (LFO2 Destination B) selects the second of the two available destinations for LFO2. Confirm a selection by pressing [YES/SAVE].

DEP (LFO2 Depth B) sets how much the LFO2 will modulate the destination chosen by the second DST parameter. The knob is bipolar (both negative and positive modulation depth is possible).

APPENDIX B: FX TRACK PARAMETERS

In this appendix, the parameters of the external input page and the three send effects are explained.

EXTERNAL IN

The EXT IN page controls the signal path from the two audio inputs to the main mixer. These external signals can be routed to the effects and panned just like the four synth tracks.

EXT



CHO (Ext. L Chorus) sets how much of the signal from the left external input to send through to the Wideshift Chorus effect.

DEL (Ext. L Delay) sets how much of the signal from the left external input to send through to the Saturator Delay effect.

REV (Ext. L Reverb) sets how much of the signal from the left external input to send through to the Supervoid Reverb effect.

PAN (Ext. L Pan) positions the signal from the left external input in the stereo field. When using the audio inputs as a stereo pair, pan this signal hard left.

VOL (Ext. L Volume) adjusts the volume of the signal from the left external input.

CHO (Ext. R Chorus) sets how much of the signal from the right external input to send through to the Wideshift Chorus effect.

DEL (Ext. R Delay) sets how much of the signal from the right external input to send through to the Saturator Delay effect.

REV (Ext. R Reverb) sets how much of the signal from the right external input to send through to the Supervoid Reverb effect.

PAN (Ext. R Pan) positions the signal coming from the right external input in the stereo field. When using the audio inputs as a stereo pair, pan this signal hard right.

VOL (Ext. R Volume) adjusts the volume of the signal coming from the right external input.

WIDESHIFT CHORUS

The Wideshift Chorus can be used to widen sounds, enhance the stereo image or add subtle movement to sounds.

CHORUS



PRE (Predelay) sets the predelay time of the Wideshift Chorus.

SPD (Speed) sets the low-frequency modulation speed of the chorus taps.

DEP (Depth) sets the depth of the modulation of the chorus taps.

WID (Width) sets the stereo width of the Wideshift Chorus.

FDB (Feedback) sets the feedback of the chorus taps.

HPF (HP Filter) sets the highpass filtering of the input signal.

LPF (LP Filter) sets the lowpass filtering of the input signal.

DEL (Delay Send) sets how much of the wet Wideshift Chorus signal to send through to the Saturator Delay.

REV (Reverb Send) sets how much of the Wideshift Chorus signal to send through to the Supervoid Reverb.

VOL (Mix Volume) adjusts the volume of the Wideshift Chorus signal.

SATURATOR DELAY

The Saturator Delay adds an echo-like effect to the audio. Thanks to the special features of this effect, it can also be used to subtly warm or severely distort the delay signal.

DELAY

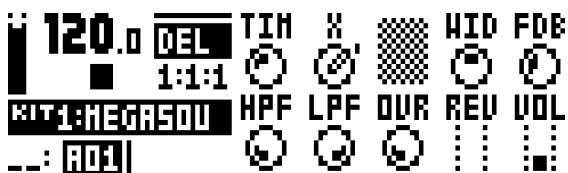

TIM (Time) sets the delay time. It is relative to the current BPM and is measured in 128th notes. For instance, a setting of 32 equals a one beat delay (four 1/16th notes).

X (Pingpong) sets how the delay signal will act in the stereo field.

- 0 makes it possible to manually situate the delay signal in the stereo field. The **WID** parameter controls the placement.
- 1 will make the delay signal alternate between left and right pan positions. The **WID** parameter controls the amount of panning.

WID (Width) sets the stereo width or placement of the delay signal.

FDB (Feedback) sets how much of the delay output that will be fed back into the input of the delay. With higher parameter settings, infinite and/or swelling delays are possible to achieve. Please be aware that high feedback can lead to a very loud signal, and that the **OVR** parameter can further increase the feedback.

HPF (HP Filter) sets the highpass filtering of the delay taps.

LPF (LP Filter) sets the lowpass filtering of the delay taps.

OVR (Overdrive) sets how much the delay signal will be overdriven. Please note that higher settings will affect the feedback of the delay.

REV (Reverb Send) sets how much of the Saturator Delay signal that will be sent to the Supervoid Reverb.

VOL (Mix Volume) adjusts the volume of the Saturator Delay signal.

SUPERVOID REVERB

The Supervoid Reverb is perfect for positioning sounds in the mix. It can simulate everything from vast locations to small spaces.

REVERB



PRE (Predelay) sets the predelay time of the Supervoid Reverb.

DEC (Decay) sets the decay of the reverberated signal, essentially setting the size of the acoustic room.

FRQ (Shelving Frequency) sets the frequency of a shelving filter. Together with the **GAI** parameter, it can be used to dampen the reverberated signal above a chosen frequency, making the reverberation sound darker.

GAI (Shelving Gain) affects the damping of the reverberated signal above the shelving frequency set by the **FRQ** parameter. At max value the treble is included in the reverberations; lowering the value gradually dampens it.

HPF (HP Filter) sets the highpass filtering of the input to the reverb.

LPF (LP Filter) sets the lowpass filtering of the input to the reverb.

VOL (Mix Volume) adjusts the volume of the Supervoid Reverb signal.

FX LFO

The FX LFO menu consists of two LFOs dedicated to modulating FX track parameters.

LFO1 (page 1)



SPD (LFO1 Speed) sets the speed of LFO1. It is synced to the BPM. For LFO1 to be synced to straight beats, try settings of 16, 32 or 64. The value is bi-polar, meaning the LFO shape can be played backward by using negative values.

MUL (LFO1 Multiplier) multiplies the SPD parameter by the set factor.

FAD (LFO1 Fade In/Out) offers the possibility to fade in/out the LFO modulation. Positive values give a fade-out, negative values give a fade-in. A mid position (0) will result in no fade in/out.

SPH (LFO1 Start Phase) sets the start position (phase) of LFO1 when triggered.

MOD (LFO1 Trig Mode) sets the LFO1 envelope action when a note is triggered. There are five settings:

- FRE is the default free-running mode. It makes LFO1 run continuously, never restarting or stopping.
- TRG makes LFO1 restart when a note is played.
- HLD makes LFO1 run free in the background, but when a note is played the output LFO1 level is latched and held still until the next note is played.
- ONE The LFO1 starts when a note is triggered, then runs to the end of the waveform and then stops. This makes the LFO function similar to an envelope.
- HLF The LFO1 starts when a note is triggered, then runs to the middle of the waveform and then stops.

WAV (LFO1 Waveform) sets the LFO1 waveform.

DST (LFO1 Destination A) selects the first of the two available destinations for LFO1. Confirm a selection by pressing [YES/SAVE].

DEP (LFO1 Depth A) sets how much LFO1 will modulate the destination chosen by the first DST parameter. The knob is bipolar (both negative and positive modulation depth is possible).

DST (LFO1 Destination B) selects the second of the two available destinations for LFO1. Confirm a selection by pressing [YES/SAVE].

DEP (LFO1 Depth B) sets how much the LFO1 will modulate the destination chosen by the second DST parameter. The knob is bipolar (both negative and positive modulation depth is possible).

LFO2 (page 2)



SPD (LFO2 Speed) sets the speed of LFO2. It is synced to the BPM. For LFO2 to be synced to straight beats, try settings of 16, 32 or 64. The value is bi-polar (the LFO shape can be played backward by using negative values).

MUL (LFO2 Multiplier) multiplies the SPD parameter by the set factor.

FAD (LFO2 Fade In/Out) offers the possibility to fade in/out the LFO modulation. Positive values give a fade-out, negative values give a fade-in. A mid position (0) will result in no fade in/out.

SPH (LFO2 Start Phase) sets the start position (phase) of LFO2 when triggered.

MOD (LFO2 Trig Mode) sets the LFO2 envelope action when a note is triggered. There are five settings:

- FRE is the default free-running mode. It makes LFO2 run continuously, never restarting or stopping.
- TRG makes LFO2 restart when a note is played.
- HLD makes LFO2 run free in the background, but when a note is played the output LFO2 level is latched and held still until the next note is played.
- ONE The LFO2 starts when a note is triggered, then runs to the end of the waveform and then stops. This makes the LFO function similar to an envelope.
- HLF The LFO2 starts when a note is triggered, then runs to the middle of the waveform and then stops.

WAV (LFO2 Waveform) sets the LFO2 waveform.

DST (LFO2 Destination A) selects the first of the two available destinations for LFO2. Confirm a selection by pressing [YES/SAVE].

DEP (LFO2 Depth A) sets how much LFO2 will modulate the destination chosen by the first DST parameter. The knob is bipolar (both negative and positive modulation depth is possible).

DST (LFO2 Destination B) selects the second of the two available destinations for LFO2. Confirm a selection by pressing [YES/SAVE].

DEP (LFO2 Depth B) sets how much the LFO2 will modulate the destination chosen by the second DST parameter. The knob is bipolar (both negative and positive modulation depth is possible).

APPENDIX C: CV TRACK PARAMETERS

In this appendix, the CV/Gate track parameters are explained.

CV A-D

The CV A-D pages control the signals sent from the 2 dual CV/Gate outputs. Depending on the CV type chosen in the CV CONFIG menu, the available parameters will change.

CV (GROUNDED)



No parameters available. The CV output will not send any signal.

CV (PITCH V/OCT)

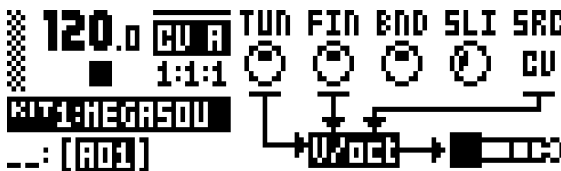

TUN (Coarse Tune) sets the coarse tuning of the CV in semitones.

FIN (Fine Tune) sets the fine tuning of the CV.

BND (Bend Depth) sets the bend depth. The higher the setting, the more the pitch of a triggered note will be offset.

SLI (Note Slide time) sets the CV control of the slide time of note slides.

SRC (Source Track) sets the track to use for sending CV signals. The CV track, FX track and synth tracks 1-4 can be used as a source.

A note on the LCD graphics: The audio plug graphics on the CV A-D PARAMETER pages will flash to indicate whether the tip or the ring of the audio cable plug is used for sending the CV/Gate signals.

CV (PITCH HZ/V)

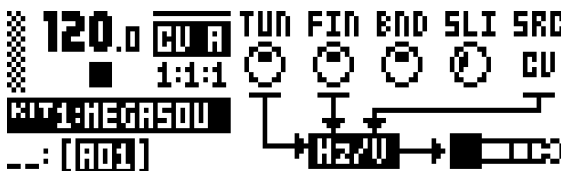

TUN (Coarse Tune) sets the coarse tuning of the CV in semitones.

FIN (Fine Tune) sets the fine tuning of the CV.

BND (Bend Depth) sets the bend depth. The higher the setting, the more the pitch of a triggered note will be offset.

SLI (Note Slide time) sets the CV control of the slide time of note slides.

SRC (Source Track) sets the track to use for sending CV signals. The CV track, FX track and synth tracks 1-4 can be used as a source.

CV (VALUE LIN)

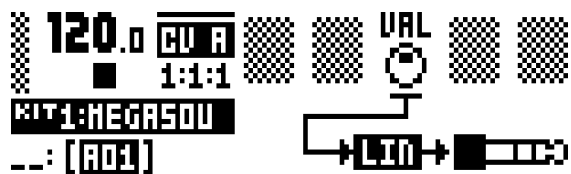

VAL (Value) sets the voltage level of the CV. Applicable when the chosen CV type is VALUE LIN.

CV (TRIG)

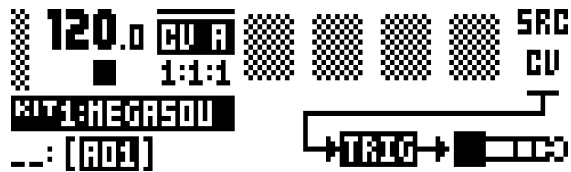

SRC (Source Track) sets the track to use for sending trig signals. The CV track, FX track and synth tracks 1-4 can be used as a source.

CV (GATE)

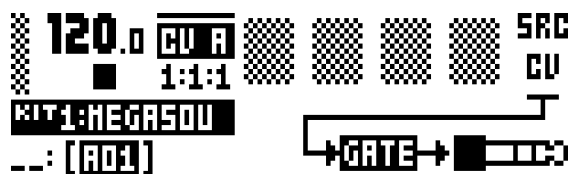

SRC (Source Track) sets the track to use for sending gate signals. The CV track, FX track and synth tracks 1-4 can be used as a source.

CV (CLOCK)

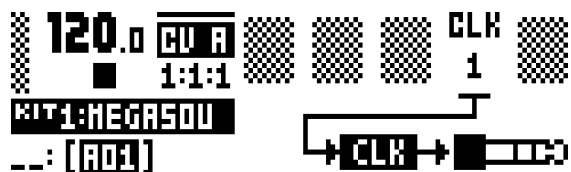

CLK (Clock Division) sets the clock division. This setting relates to the BPM of the sequencer.

CV ENVELOPES

Here parameters controlling the two assignable CV envelopes are found. The CV envelopes can modulate parameters found on the CV track. They can also be sent to the CV/Gate outputs, by setting up a CV channel's type as VALUE LIN.

ENV1 (page 1)



ATK (Env1 Attack) sets the attack time of the Env1 envelope.

DEC (Env1 Decay) sets the decay time of the Env1 envelope.

SUS (Env1 Sustain) sets the sustain level of the Env1 envelope.

REL (Env1 Release) sets the release time of the Env1 envelope.

SHP (Env1 Shape) sets the general shape of the Env1 envelope. Several linear and exponential shapes are available. A dot to the left of the visual representation of the envelope indicates that the envelope will restart from level zero. In other cases, it will start from the level it had when being triggered.

LEN (Env1 Gate length) makes it possible to choose another gate length than whatever triggered the envelope.

DST (Env1 Destination A) selects the first of the two available destinations for the Env1 envelope. Confirm a selection by pressing **[YES/SAVE]**.

DEP (Env1 Depth A) sets how much the envelope will modulate the destination chosen by the first DST parameter. The knob is bipolar (both negative and positive modulation depth is possible).

DST (Env1 Destination B) selects the second of the two available destinations for the Env1 envelope. Confirm a selection by pressing **[YES/SAVE]**.

DEP (Env1 Depth B) sets how much the envelope will modulate the destination chosen by the second DST parameter. The knob is bipolar (both negative and positive modulation depth is possible).

ENV2 (page 2)



ATK (Env2 Attack) sets the attack time of the Env2 envelope.

DEC (Env2 Decay) sets the decay time of the Env2 envelope.

SUS (Env2 Sustain) sets the sustain level of the Env2 envelope.

REL (Env2 Release) sets the release time of the Env2 envelope.

SHP (Env2 Shape) sets the general shape of the Env2 envelope. Several linear and exponential shapes are available. A dot to the left of the visual representation of the envelope indicates that the envelope will restart from level zero. In other cases, it will start from the level it had when being triggered.

LEN (Env2 Gate length) makes it possible to choose another gate length than whatever triggered the envelope.

DST (Env2 Destination A) selects the first of the two available destinations for the Env2 envelope. Confirm a selection by pressing **[YES/SAVE]**.

DEP (Env2 Depth A) sets how much the envelope will modulate the destination chosen by the first DST parameter. The knob is bipolar (both negative and positive modulation depth is possible).

DST (Env2 Destination B) selects the second of the two available destinations for the Env2 envelope. Confirm a selection by pressing **[YES/SAVE]**.

DEP (Env2 Depth B) sets how much the envelope will modulate the destination chosen by the second DST parameter. The knob is bipolar (both negative and positive modulation depth is possible).

CV LFO

The two CV LFOs can be used to modulate other CV track parameters. They can also be sent to the CV/Gate outputs, by setting up a CV channel's type as VALUE LIN and then letting the LFO modulate its VAL parameter.

LFO1 (page 1)



SPD (LFO1 Speed) sets the speed of LFO1. It is synced to the BPM. For LFO1 to be synced to straight beats, try settings of 16, 32 or 64. The value is bi-polar (the LFO shape can be played backward by using negative values).

MUL (LFO1 Multiplier) multiplies the SPD parameter by the set factor.

FAD (LFO1 Fade In/Out) offers the possibility to fade in/out the LFO modulation. Positive values give a fade-out, negative values give a fade-in. A mid position (0) will result in no fade in/out.

SPH (LFO1 Start Phase) sets the start position (phase) of LFO1 when triggered.

MOD (LFO1 Trig Mode) sets the LFO1 action when triggered. There are five settings:

- FRE is the default free-running mode. It makes LFO1 run continuously, never restarting or stopping.
- TRG makes LFO1 restart when a note is played.
- HLD makes LFO1 run free in the background, but when a note is played the output LFO1 level is latched and held still until the next note is played.
- ONE The LFO1 starts when a note is triggered, then runs to the end of the waveform and then stops. This makes the LFO function similar to an envelope.
- HLF The LFO1 starts when a note is triggered, then runs to the middle of the waveform and then stops.

WAV (LFO1 Waveform) sets the LFO1 waveform.

DST (LFO1 Destination A) selects the first of the two available destinations for LFO1. Confirm a selection by pressing [YES/SAVE].

DEP (LFO1 Depth A) sets how much LFO1 will modulate the destination chosen by the first DST parameter. The knob is bipolar (both negative and positive modulation depth is possible).

DST (LFO1 Destination B) selects the second of the two available destinations for LFO1. Confirm a selection by pressing [YES/SAVE].

DEP (LFO1 Depth B) sets how much the LFO1 will modulate the destination chosen by the second DST parameter. The knob is bipolar (both negative and positive modulation depth is possible).

LFO2 (page 2)



SPD (LFO2 Speed) sets the speed of LFO2. It is synced to the BPM. For LFO2 to be synced to straight beats, try settings of 16, 32 or 64. The value is bi-polar (the LFO shape can be played backward by using negative values).

MUL (LFO2 Multiplier) multiplies the SPD parameter by the set factor.

FAD (LFO2 Fade In/Out) offers the possibility to fade in/out the LFO modulation. Positive values give a fade-out, negative values give a fade-in. A mid position (0) will result in no fade in/out.

SPH (LFO2 Start Phase) sets the start position (phase) of LFO2 when triggered.

MOD (LFO2 Trig Mode) sets the LFO2 action when triggered. There are five settings:

- FRE is the default free-running mode. It makes LFO2 run continuously, never restarting or stopping.
- TRG makes LFO2 restart when a note is played.
- HLD makes LFO2 run free in the background, but when a note is played the output LFO2 level is latched and held still until the next note is played.
- ONE The LFO2 starts when a note is triggered, then runs to the end of the waveform and then stops. This makes the LFO function similar to an envelope.
- HLF The LFO2 starts when a note is triggered, then runs to the middle of the waveform and then stops.

WAV (LFO2 Waveform) sets the LFO2 waveform.

DST (LFO2 Destination A) selects the first of the two available destinations for LFO2. Confirm a selection by pressing [YES/SAVE].

DEP (LFO2 Depth A) sets how much LFO2 will modulate the destination chosen by the first DST parameter. The knob is bipolar (both negative and positive modulation depth is possible).

DST (LFO2 Destination B) selects the second of the two available destinations for LFO2. Confirm a selection by pressing [YES/SAVE].

DEP (LFO2 Depth B) sets how much the LFO2 will modulate the destination chosen by the second DST parameter. The knob is bipolar (both negative and positive modulation depth is possible).

APPENDIX D: MIDI

This appendix covers the MIDI CC and NRPN implementation. The data range of each parameters CC and/ or NRPN value is written in parentheses after the value.

TRACK PARAMETERS

PERFORMANCE					
Parameter	Encoder	CC MSB	CC LSB	NRPN MSB	NRPN LSB
Mute		94 (0-127)	-	1	101 (0-127)
Track Level		95 (0-127)	-	1	100 (0-127)

PERFORMANCE PARAMETERS

The following messages affect the performance parameters on all tracks. They are also sent when adjusting the knobs controlling the parameters.

PERFORMANCE					
Parameter	Encoder	CC MSB	CC LSB	NRPN MSB	NRPN LSB
Performance Parameter A	A	3 (0-127)	-	0	0 (0-127)
Performance Parameter B	B	4 (0-127)	-	0	1 (0-127)
Performance Parameter C	C	8 (0-127)	-	0	2 (0-127)
Performance Parameter D	D	9 (0-127)	-	0	3 (0-127)
Performance Parameter E	E	11 (0-127)	-	0	4 (0-127)
Performance Parameter F	F	64 (0-127)	-	0	5 (0-127)
Performance Parameter G	G	65 (0-127)	-	0	6 (0-127)
Performance Parameter H	H	66 (0-127)	-	0	7 (0-127)
Performance Parameter I	I	67 (0-127)	-	0	8 (0-127)
Performance Parameter J	J	68 (0-127)	-	0	9 (0-127)

MODULATION PARAMETERS

The following messages affect modulation parameters. Which parameters they will in turn affect are set in the SOUND SETTINGS menu (where modulation parameters for velocity, pitch bend and aftertouch can also be found). For more information, please see "9.10 SETTINGS" on page 34.

MODULATION					
Parameter	Encoder	CC MSB	CC LSB	NRPN MSB	NRPN LSB
Modwheel	-	1 (0-127)	33 (0-127)	-	-
Breath Controller	-	2 (0-127)	34 (0-127)	-	-

The following messages affect the track level parameter.

COMMON					
Parameter	Encoder	CC MSB	CC LSB	NRPN MSB	NRPN LSB
Track Level	-	95 (0-127)	-	1 (0-127)	100

SYNTH TRACK PARAMETERS

The following messages affect the synth track parameters. They are also sent when adjusting the knobs controlling the parameters.

OSC 1					
Parameter	Encoder	CC MSB	CC LSB	NRPN MSB	NRPN LSB
Pitch	A	16 (0-127)	48 (0-127)	1 (0-127)	0 (0-127)
	B	-	-	1 (0-127)	
Detune	C	-	-	1 (0-127)	2
	D	-	-	1 (0-127)	3
Level	E	69 (0-127)	-	1 (0-127)	4
Waveform	F	70 (0-127)	-	1 (0-127)	5
Sub Oscillator	G	71 (0-127)	-	1 (0-127)	6
Pulsewidth	H	72 (0-127)	-	1 (0-127)	7
PWM Speed	I	73 (0-127)	-	1 (0-127)	
PWM Depth	J	74 (0-127)	-	1 (0-127)	9

NOISE					
Parameter	Encoder	CC MSB	CC LSB	NRPN MSB	NRPN LSB
Noise S&H	A	75 (0-127)	-	1 (0-127)	10
	B	-	-	1 (0-127)	
Noise Fade	C	76 (0-127)	-	1 (0-127)	12
	D	-	-	1 (0-127)	
Noise Level	E	77 (0-127)	-	1 (0-127)	14
	F	-	-	1 (0-127)	
	G	-	-	1 (0-127)	
	H	-	-	1 (0-127)	
	I	-	-	1 (0-127)	
	J	-	-	1 (0-127)	

OSC 2					
Parameter	Encoder	CC MSB	CC LSB	NRPN MSB	NRPN LSB
Pitch	A	17 (0-127)	49 (0-127)	1 (0-127)	20 (0-127)
	B	-	-	1 (0-127)	
Detune	C	-	-	1 (0-127)	22
	D	-	-	1 (0-127)	23
Level	E	78 (0-127)	-	1 (0-127)	24
Waveform	F	79 (0-127)	-	1 (0-127)	25
Sub Oscillator	G	80 (0-127)	-	1 (0-127)	26
Pulsewidth	H	81 (0-127)	-	1 (0-127)	27
PWM Speed	I	82 (0-127)	-	1 (0-127)	
PWM Depth	J	83 (0-127)	-	1 (0-127)	29

OSC COMMON					
Parameter	Encoder	CC MSB	CC LSB	NRPN MSB	NRPN LSB
OSC1 AM	A	-	-	1 (0-127)	30
Sync Mode	B	-	-	1 (0-127)	31
Sync Amount	C	84 (0-127)	-	1 (0-127)	32

OSC COMMON					
Parameter	Encoder	CC MSB	CC LSB	NRPN MSB	NRPN LSB
Bend Amount	D	85 (0-127)	-	1 (0-127)	33
Slide Time	E	5 (0-127)	-	1 (0-127)	34
OSC2 AM	F	-	-	1 (0-127)	35
Note Sync	G	-	-	1 (0-127)	36
Vibrato Fade	H	-	-	1 (0-127)	37
Vibrato Speed	I	87 (0-127)	-	1 (0-127)	38
Vibrato Depth	J	88 (0-127)	-	1 (0-127)	39

FILTERS					
Parameter	Encoder	CC MSB	CC LSB	NRPN MSB	NRPN LSB
Filter1 Frequency	A	18 (0-127)	50 (0-127)	1 (0-127)	40 (0-127)
Filter1 Resonance	B	89 (0-127)	-	1 (0-127)	41
Filter Overdrive	C	86 (0-127)	-	1 (0-127)	42
Filter1 Keytracking	D	-	-	1 (0-127)	43
Filter1 Envelope Amount	E	102 (0-127)	-	1 (0-127)	44
Filter2 Frequency	F	19 (0-127)	51 (0-127)	1 (0-127)	45 (0-127)
Filter2 Resonance	G	90 (0-127)	-	1 (0-127)	46
Filter2 Type	H	-	-	1 (0-127)	47
Filter2 Keytracking	I	-	-	1 (0-127)	48
Filter2 Envelope Amount	J	103 (0-127)	-	1 (0-127)	49

AMP					
Parameter	Encoder	CC MSB	CC LSB	NRPN MSB	NRPN LSB
EnvA Attack Time	A	104 (0-127)	-	1 (0-127)	50
EnvA Decay Time	B	105 (0-127)	-	1 (0-127)	51
EnvA Sustain Level	C	106 (0-127)	-	1 (0-127)	52
EnvA Release Time	D	107 (0-127)	-	1 (0-127)	53
EnvA Env Shape	E	-	-	1 (0-127)	54
Chorus Send Level	F	91 (0-127)	-	1 (0-127)	55
Delay Send Level	G	92 (0-127)	-	1 (0-127)	56
Reverb Send Level	H	93 (0-127)	-	1 (0-127)	57
Pan	I	10 (0-127)	-	1 (0-127)	58
Volume	J	7 (0-127)	-	1 (0-127)	59

ENVF					
Parameter	Encoder	CC MSB	CC LSB	NRPN MSB	NRPN LSB
EnvF Attack Time	A	108 (0-127)	-	1 (0-127)	60
EnvF Decay Time	B	109 (0-127)	-	1 (0-127)	61
EnvF Sustain Level	C	110 (0-127)	-	1 (0-127)	62
EnvF Release Time	D	111 (0-127)	-	1 (0-127)	63
EnvF Env Shape	E	-	-	1 (0-127)	64
EnvF Gate Length	F	-	-	1 (0-127)	65
EnvF Destination A	G	-	-	1 (0-127)	66
EnvF Depth A	H	20 (0-127)	52 (0-127)	1 (0-127)	67 (0-127)

ENVF					
Parameter	Encoder	CC MSB	CC LSB	NRPN MSB	NRPN LSB
EnvF Destination B	I	-	-	1 (0-127)	68
EnvF Depth B	J	21 (0-127)	53 (0-127)	1 (0-127)	69 (0-127)

ENV2					
Parameter	Encoder	CC MSB	CC LSB	NRPN MSB	NRPN LSB
Env2 Attack Time	A	112 (0-127)	-	1 (0-127)	70
Env2 Decay Time	B	113 (0-127)	-	1 (0-127)	71
Env2 Sustain Level	C	114 (0-127)	-	1 (0-127)	72
Env2 Release Time	D	115 (0-127)	-	1 (0-127)	73
Env2 Env Shape	E	-	-	1 (0-127)	74
Env2 Gate Length	F	-	-	1 (0-127)	75
Env2 Destination A	G	-	-	1 (0-127)	76
Env2 Depth A	H	22 (0-127)	54 (0-127)	1 (0-127)	77 (0-127)
Env2 Destination B	I	-	-	1 (0-127)	78
Env2 Depth B	J	23 (0-127)	55 (0-127)	1 (0-127)	79 (0-127)

LFO1					
Parameter	Encoder	CC MSB	CC LSB	NRPN MSB	NRPN LSB
LFO1 Speed	A	116 (0-127)	-	1 (0-127)	80
LFO1 Speed Multiplier	B	117 (0-127)	-	1 (0-127)	81
LFO1 Fade	C	-	-	1 (0-127)	82
LFO1 Start Phase	D	-	-	1 (0-127)	83
LFO1 Mode	E	-	-	1 (0-127)	84
LFO1 Waveform	F	-	-	1 (0-127)	85
LFO1 Destination A	G	-	-	1 (0-127)	86
LFO1 Depth A	H	24 (0-127)	56 (0-127)	1 (0-127)	87 (0-127)
LFO1 Destination B	I	-	-	1 (0-127)	88
LFO1 Depth B	J	25 (0-127)	57 (0-127)	1 (0-127)	89 (0-127)

LFO2					
Parameter	Encoder	CC MSB	CC LSB	NRPN MSB	NRPN LSB
LFO2 Speed	A	118 (0-127)	-	1 (0-127)	90
LFO2 Speed Multiplier	B	119 (0-127)	-	1 (0-127)	91
LFO2 Fade	C	-	-	1 (0-127)	92
LFO2 Start Phase	D	-	-	1 (0-127)	93
LFO2 Mode	E	-	-	1 (0-127)	94
LFO2 Waveform	F	-	-	1 (0-127)	95
LFO2 Destination A	G	-	-	1 (0-127)	96
LFO2 Depth A	H	26 (0-127)	58 (0-127)	1 (0-127)	97 (0-127)
LFO2 Destination B	I	-	-	1 (0-127)	98
LFO2 Depth B	J	27 (0-127)	59 (0-127)	1 (0-127)	99 (0-127)

FX TRACK PARAMETERS

The following messages affect the FX track parameters. They are also sent when adjusting the knobs controlling the parameters.

EXT IN					
Parameter	Encoder	CC MSB	CC LSB	NRPN MSB	NRPN LSB
Ch1 Chorus Send	A	-	-	2 (0-127)	0
Ch1 Delay Send	B	-	-	2 (0-127)	1
Ch1 Reverb Send	C	-	-	2 (0-127)	2
Ch1 Pan	D	-	-	2 (0-127)	3
Ch1 Level	E	-	-	2 (0-127)	4
Ch2 Chorus Send	F	-	-	2 (0-127)	5
Ch2 Delay Send	G	-	-	2 (0-127)	6
Ch2 Reverb Send	H	-	-	2 (0-127)	7
Ch2 Pan	I	-	-	2 (0-127)	8
Ch2 Level	J	-	-	2 (0-127)	9

CHORUS					
Parameter	Encoder	CC MSB	CC LSB	NRPN MSB	NRPN LSB
Predelay	A	-	-	2 (0-127)	40
Speed	B	-	-	2 (0-127)	41
Depth	C	-	-	2 (0-127)	42
Width	D	-	-	2 (0-127)	43
Feedback	E	-	-	2 (0-127)	44
HP Filter	F	-	-	2 (0-127)	45
LP Filter	G	-	-	2 (0-127)	46
Delay Send	H	-	-	2 (0-127)	47
Reverb Send	I	-	-	2 (0-127)	48
Send Level	J	-	-	2 (0-127)	49

DELAY					
Parameter	Encoder	CC MSB	CC LSB	NRPN MSB	NRPN LSB
Time	A	-	-	2 (0-127)	50
Mode	B	-	-	2 (0-127)	51
	C	-	-	2 (0-127)	52
Width	D	-	-	2 (0-127)	53
Feedback	E	-	-	2 (0-127)	54
HP Filter	F	-	-	2 (0-127)	55
LP Filter	G	-	-	2 (0-127)	56
Overdrive	H	-	-	2 (0-127)	57
Reverb Send	I	-	-	2 (0-127)	58
Send Level	J	-	-	2 (0-127)	59

REVERB					
Parameter	Encoder	CC MSB	CC LSB	NRPN MSB	NRPN LSB
Predelay	A	-	-	2 (0-127)	60
Decay Time	B	-	-	2 (0-127)	61
Shelving Freq	C	-	-	2 (0-127)	62

REVERB					
Parameter	Encoder	CC MSB	CC LSB	NRPN MSB	NRPN LSB
Shelving Gain	D	-	-	2 (0-127)	63
	E	-	-	2 (0-127)	64
HP Filter	F	-	-	2 (0-127)	65
LP Filter	G	-	-	2 (0-127)	66
	H	-	-	2 (0-127)	67
	I	-	-	2 (0-127)	68
Send Level	J	-	-	2 (0-127)	69

LFO1					
Parameter	Encoder	CC MSB	CC LSB	NRPN MSB	NRPN LSB
LFO1 Speed	A	-	-	2 (0-127)	80
LFO1 Speed Multiplier	B	-	-	2 (0-127)	81
LFO1 Fade	C	-	-	2 (0-127)	82
LFO1 Start Phase	D	-	-	2 (0-127)	83
LFO1 Mode	E	-	-	2 (0-127)	84
LFO1 Waveform	F	-	-	2 (0-127)	85
LFO1 Destination 1	G	-	-	2 (0-127)	86
LFO1 Depth 1	H	-	-	2 (0-127)	87 (0-127)
LFO1 Destination 2	I	-	-	2 (0-127)	88
LFO1 Depth 2	J	-	-	2 (0-127)	89 (0-127)

LFO2					
Parameter	Encoder	CC MSB	CC LSB	NRPN MSB	NRPN LSB
LFO2 Speed	A	-	-	2 (0-127)	90
LFO2 Speed Multiplier	B	-	-	2 (0-127)	91
LFO2 Fade	C	-	-	2 (0-127)	92
LFO2 Start Phase	D	-	-	2 (0-127)	93
LFO2 Mode	E	-	-	2 (0-127)	94
LFO2 Waveform	F	-	-	2 (0-127)	95
LFO2 Destination 1	G	-	-	2 (0-127)	96
LFO2 Depth 1	H	-	-	2 (0-127)	97 (0-127)
LFO2 Destination 2	I	-	-	2 (0-127)	98
LFO2 Depth 2	J	-	-	2 (0-127)	99 (0-127)

CV TRACK PARAMETERS

The following messages affect the CV track parameters. They are also sent when adjusting the knobs controlling the parameters.

CV A					
Parameter	Encoder	CC MSB	CC LSB	NRPN MSB	NRPN LSB
CV A Coarse Tune	A	-	-	3 (0-127)	0
CV A Fine Tune	B	-	-	3 (0-127)	1
CV A Value	C	-	-	3 (0-127)	2
CV A Clock	D	-	-	3 (0-127)	3
CV A Source	E	-	-	3 (0-127)	4

CV A					
Parameter	Encoder	CC MSB	CC LSB	NRPN MSB	NRPN LSB
CV A Bend Depth	F	-	-	3 (0-127)	5
CV A Note Slide time	G	-	-	3 (0-127)	6
	H	-	-	3 (0-127)	-
	I	-	-	3 (0-127)	-
	J	-	-	3 (0-127)	-

CV B					
Parameter	Encoder	CC MSB	CC LSB	NRPN MSB	NRPN LSB
CV B Coarse Tune	A	-	-	3 (0-127)	20
CV B Fine Tune	B	-	-	3 (0-127)	21
CV B Value	C	-	-	3 (0-127)	22
CV B Clock	D	-	-	3 (0-127)	23
CV B Source	E	-	-	3 (0-127)	24
CV B Bend Depth	F	-	-	3 (0-127)	25
CV B Note Slide time	G	-	-	3 (0-127)	26
	H	-	-	3 (0-127)	-
	I	-	-	3 (0-127)	-
	J	-	-	3 (0-127)	-

CV C					
Parameter	Encoder	CC MSB	CC LSB	NRPN MSB	NRPN LSB
CV C Coarse Tune	A	-	-	3 (0-127)	40
CV C Fine Tune	B	-	-	3 (0-127)	41
CV C Value	C	-	-	3 (0-127)	42
CV C Clock	D	-	-	3 (0-127)	43
CV C Source	E	-	-	3 (0-127)	44
CV C Bend Depth	F	-	-	3 (0-127)	45
CV C Note Slide time	G	-	-	3 (0-127)	46
	H	-	-	3 (0-127)	-
	I	-	-	3 (0-127)	-
	J	-	-	3 (0-127)	-

CV D					
Parameter	Encoder	CC MSB	CC LSB	NRPN MSB	NRPN LSB
CV D Coarse Tune	A	-	-	3 (0-127)	50
CV D Fine Tune	B	-	-	3 (0-127)	51
CV D Value	C	-	-	3 (0-127)	52
CV D Clock	D	-	-	3 (0-127)	53
CV D Source	E	-	-	3 (0-127)	54
CV D Bend Depth	F	-	-	3 (0-127)	55
CV D Note Slide time	G	-	-	3 (0-127)	56
	H	-	-	3 (0-127)	-
	I	-	-	3 (0-127)	-
	J	-	-	3 (0-127)	-

ENV1					
Parameter	Encoder	CC MSB	CC LSB	NRPN MSB	NRPN LSB
Env1 Attack Time	A	-	-	3 (0-127)	60
Env1 Decay Time	B	-	-	3 (0-127)	61
Env1 Sustain Level	C	-	-	3 (0-127)	62
Env1 Release Time	D	-	-	3 (0-127)	63
Env1 Env Shape	E	-	-	3 (0-127)	64
Env1 Gate Length	F	-	-	3 (0-127)	65
Env1 Destination 1	G	-	-	3 (0-127)	66
Env1 Depth 1	H	-	-	3 (0-127)	67 (0-127)
Env1 Destination 2	I	-	-	3 (0-127)	68
Env1 Depth 2	J	-	-	3 (0-127)	69 (0-127)

ENV2					
Parameter	Encoder	CC MSB	CC LSB	NRPN MSB	NRPN LSB
Env2 Attack Time	A	-	-	3 (0-127)	70
Env2 Decay Time	B	-	-	3 (0-127)	71
Env2 Sustain Level	C	-	-	3 (0-127)	72
Env2 Release Time	D	-	-	3 (0-127)	73
Env2 Env Shape	E	-	-	3 (0-127)	74
Env2 Gate Length	F	-	-	3 (0-127)	75
Env2 Destination 1	G	-	-	3 (0-127)	76
Env2 Depth 1	H	-	-	3 (0-127)	77 (0-127)
Env2 Destination 2	I	-	-	3 (0-127)	78
Env2 Depth 2	J	-	-	3 (0-127)	79 (0-127)

LFO1					
Parameter	Encoder	CC MSB	CC LSB	NRPN MSB	NRPN LSB
LFO1 Speed	A	-	-	3 (0-127)	80
LFO1 Speed Multiplier	B	-	-	3 (0-127)	81
LFO1 Fade	C	-	-	3 (0-127)	82
LFO1 Start Phase	D	-	-	3 (0-127)	83
LFO1 Mode	E	-	-	3 (0-127)	84
LFO1 Waveform	F	-	-	3 (0-127)	85
LFO1 Destination 1	G	-	-	3 (0-127)	86
LFO1 Depth 1	H	-	-	3 (0-127)	87 (0-127)
LFO1 Destination 2	I	-	-	3 (0-127)	88
LFO1 Depth 2	J	-	-	3 (0-127)	89 (0-127)

LFO2					
Parameter	Encoder	CC MSB	CC LSB	NRPN MSB	NRPN LSB
LFO2 Speed	A	-	-	3 (0-127)	90
LFO2 Speed Multiplier	B	-	-	3 (0-127)	91
LFO2 Fade	C	-	-	3 (0-127)	92
LFO2 Start Phase	D	-	-	3 (0-127)	93
LFO2 Mode	E	-	-	3 (0-127)	94
LFO2 Waveform	F	-	-	3 (0-127)	95

LFO2					
Parameter	Encoder	CC MSB	CC LSB	NRPN MSB	NRPN LSB
LFO2 Destination 1	G	-	-	3 (0-127)	96
LFO2 Depth 1	H	-	-	3 (0-127)	97 (0-127)
LFO2 Destination 2	I	-	-	3 (0-127)	98
LFO2 Depth 2	J	-	-	3 (0-127)	99 (0-127)

APPENDIX E: ANALOG FOUR ARCHITECTURE

This appendix shows the complete architecture and constituent parts of the Analog Four. Gray boxes show analog elements. White boxes show digital elements.

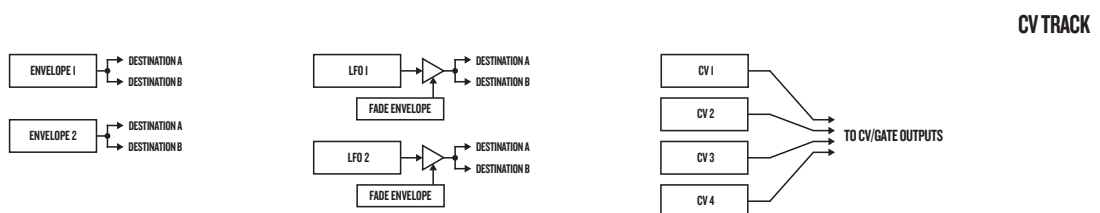
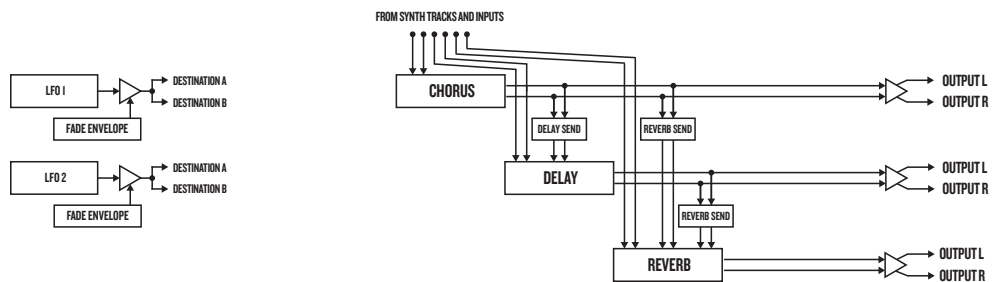
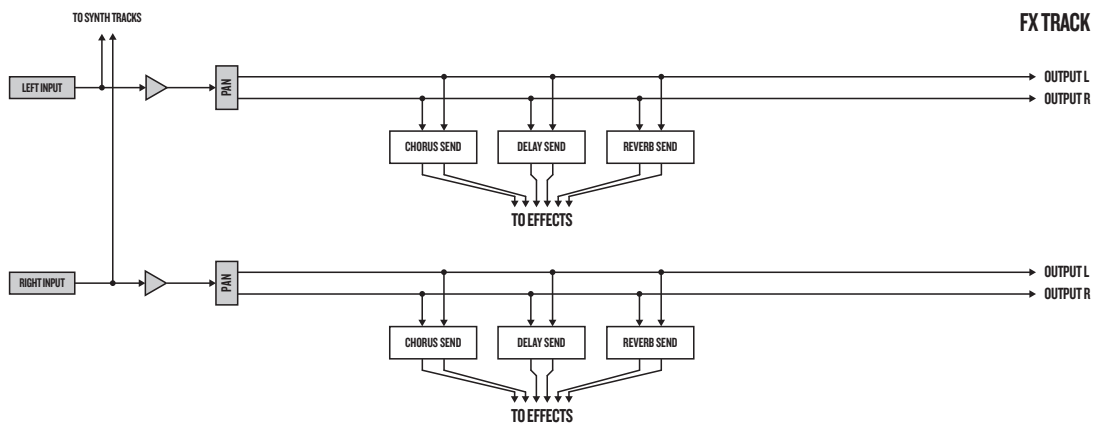
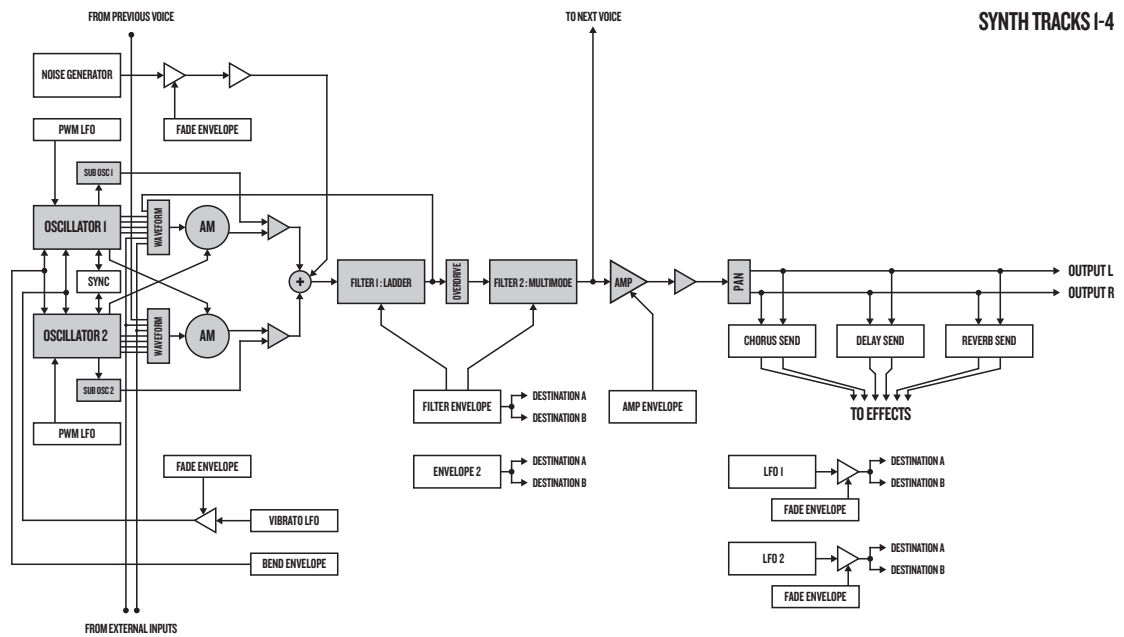

INDEX

+DRIVE 16**A****ACCENT 49****ACCESSORIES 14**

Carrying bag and protective lid 14

Rack mount kit 14

ARPEGGIATOR 42

Arpeggiator setup 43

B**BACKUP 20****C****CHAINS 53****CLICK TRACK 45****CONDITIONAL LOCKS 48****CONNECTING THE UNIT 14****COPY, PASTE AND CLEAR**

Kit 26

Pattern 51

Track 51

Track page 51

Trig 51

CREDITS 82

Contact information 82

Design and development 82

CV TRACK 36**D****DATA STRUCTURE 16****E****EARLY STARTUP MENU 67****EDIT**

CV track 37

FX track 36

Sound 36

ELECTRICAL SPECIFICATIONS 81**EMPTY RESET 67****F****FILTERS 69**

2-Pole 69

4-Pole 69

FX TRACK 36**G****GLOBAL MENU 56**

CV config 61

Global slot 56

MIDI config 57

Project menu 56

Sequencer config 56

Synth config 56

SysEx dump 63

GRID RECORDING MODE 40**K****KITS 25**

Clear kit 26

Load kit 25

Performance mode 26

Reload kit 25

Save kit 26

L**LCD SCREEN 18****LEGATO MODE 35****LIVE RECORDING MODE 40****LOADING**

Kit 25

Song 55

M**METRONOME 45****MIDI**

Auto channel 59

MIDI channels 58

MIDI port config 57

MIDI sync 57

MULTI MAP 59

Entries 59

External trig 60

Internal trig 60

Pattern play 61

MUTE

Track 37

N**NAMING MENU 19**

Pop up naming menu 19

NOTE MENU 44**NOTE SLIDE 49****O****OSCILLATORS 68**

Sub oscillators 68

Waveforms 68, 69

OVERBRIDGE 19**P****PARAMETER EDITING 18**

Parameter value skip 18

PARAMETER LOCKS 47**PARAMETER SLIDE 50****PATTERN MODES 39**

Direct jump 39

Direct start 39

Sequential 39

PATTERNS

Copy 51

Copy track 51

Copy track page 51

Copy trig 51

Grid recording mode 40

Live recording mode 40

Pattern modes 39

Recording modes 40

Tempo 39

Trig types 39

PERFORMANCE MODE 26

Performance setup 27

POLYPHONY 28

Allocation 29

Configuration 28

Voice routing 29

Voices 28

PORTAMENTO 35

PROJECTS

Load project 23

Manage project 24

Save project 23

PURGE (REMOVE UNUSED)

Sounds 34

Q

QUICK KEYS 79

QUICK RELOAD 51

Kit 51

Pattern 52

Song 52

Sound 51

Track 52

QUICK SAVE 51

Kit 51

Pattern 51

Song 51

Sound 51

Track 51

QUICK SCROLLING 18

QUICK START 22

R

RACK MOUNT KIT 14

RANDOMIZE PARAMETERS 83

RECORDING MODES

Grid recording mode 40

Live recording mode 40

Step recording mode 40

S

SAFETY AND MAINTENANCE 3

SAVING

Kits 26

Patterns 42

Songs 55

Tracks 42

SCALE SETUP

Advanced mode 46

Normal mode 46

SEQUENCER RECORDING MODES

Step recording mode 40

SETUP EXAMPLES 20, 72

SONGS 53

Transpose 54

SOUND BROWSER 32

SOUND LOCKS 48

SOUND MANAGER 33

SOUND MENU 32

SOUNDS

Clear Sound 34

Editing a Sound 36

Legato mode 35

Playing a Sound 35

Portamento 35

Purging 34

Rename Sound 34

STEP RECORDING MODE 40

SWING 50

SYSEX DUMP 63

SysEx receive 64

SysEx send 64

T

TEMPO 39

Tap tempo 39

Tempo nudge 39

TRANSCOPE

Destructive transpose 51

Song 54

Track 50

TRIG MUTE 49

TRIGS

Accent 49

Conditional lock 48

Note 39

Note slide 49

Parameter lock 47

Parameter slide 50

Sound lock 48

Trigless lock 40

Trig mute 49

V

VELOCITY

Sequencer note value 44

Set fixed value 60

To volume 35

Velocity mod menu 35

 *elektron*