

Digitone II

User Manual



elektron

FCC compliance statement

This device complies with part 15 of the FCC rules. Operation is subject to the following two conditions: (1) This device may not cause harmful interference, and (2) this device must accept any interference received, including interference that may cause undesired operation.

NOTE: This equipment has been tested and found to comply with the limits for a Class B digital device, pursuant to Part 15 of the FCC Rules. These limits are designed to provide reasonable protection against harmful interference in a residential installation. This equipment generates, uses and can radiate radio frequency energy and, if not installed and used in accordance with the instructions, may cause harmful interference to radio communications. However, there is no guarantee that interference will not occur in a particular installation. If this equipment does cause harmful interference to radio or television reception, which can be determined by turning the equipment off and on, the user is encouraged to try to correct the interference by one or more of the following measures:

- Reorient or relocate the receiving antenna.
- Increase the separation between the equipment and receiver.
- Connect the equipment into an outlet on a circuit different from that to which the receiver is connected.
- Consult the dealer or an experienced radio/TV technician for help.



WARNING: Cancer and Reproductive Harm – www.P65Warnings.ca.gov

AVERTISSEMENT: Cancer et effet nocif sur la reproduction – www.P65Warnings.ca.gov

ADVERTENCIA: Cáncer y Daño Reproductivo – www.P65Warnings.ca.gov

Canada

This Class B digital apparatus complies with Canadian ICES-003.
Cet appareil numérique de la classe B est conforme à la norme NMB-003.

European Union regulation compliance statement

This product has been tested to comply with the Low Voltage Directive 2014/35/EU and the Electro-magnetic Compatibility Directive 2014/30/EU. The product meets the requirements of RoHS 2 Directive 2011/65/EU.



This symbol indicates that your product must be disposed of properly according to local laws and regulations.

Legal disclaimer

The information in this document is subject to change without notice and should not be construed as a commitment by Elektron. Elektron assumes no responsibility for any errors that may appear in this document. Elektron may also make improvements and/or changes in the products and programs described in this document at any time without notice. In no event shall Elektron be liable for any special, indirect, or consequential damages or any damages whatsoever resulting from loss of use, data, or profits, whether in an action of contract, negligence, or other action, arising out of or in connection with the use or performance of this information.

IMPORTANT SAFETY AND MAINTENANCE INSTRUCTIONS

Please read these instructions carefully and adhere to the operating advice.

1. Do not use this unit near water.
2. Never use aggressive cleaners on the casing or on the screen. Remove dust, dirt and fingerprints with a soft, dry and non-abrasive cloth. More persistent dirt can be removed with a slightly damp cloth using only water. Disconnect all cables while doing this. Only reconnect them when the product is safely dry.
3. Install in accordance with the manufacturer's instructions. Make sure you place the unit on a stable surface before use. If you mount the unit in a rack, be sure to tighten all four screws in the rack mount holes.
4. Connect the unit to an easily accessible electrical outlet close to the unit.
5. When transporting the unit, use accessories recommended by the manufacturer or the original box and padding.
6. Do not install near any heat sources such as radiators, heat registers, stoves, or any other equipment (including amplifiers) producing heat.
7. Do not put the PL-2S Protective Cover (Elektron accessory) on the unit while the unit is powered on.
8. This product, by itself or in combination with amplifiers, headphones or speakers, is capable of producing sound levels that may cause permanent hearing loss. Do not operate at a high volume level or at a level that is uncomfortable.
9. Protect the power cord from being walked on or pinched particularly at plugs, convenience receptacles, and the point where they exit from the unit.
10. Only use attachments/accessories specified by the manufacturer.
11. Unplug this unit during lightning storms or when it is not used for long periods of time.
12. Refer all servicing to qualified service technicians. Servicing is required when the unit has been damaged in any way, liquid has been spilled or objects have fallen into the unit, the unit has been exposed to rain or moisture, does not operate normally, or has been dropped.

WARNING

To reduce the risk of fire, electrical shock or product damage:

- Do not expose the unit to rain, moisture, dripping or splashing and also avoid placing objects filled with liquid, such as vases, on the unit.
- Do not expose the unit to direct sunlight, nor use it in ambient temperatures exceeding 40°C as this can lead to malfunction.
- Do not open the casing. There are no user repairable or adjustable parts inside. Leave service and repairs to trained service technicians only.
- Do not exceed the limitations specified in the Electrical specifications.

SAFETY INSTRUCTIONS FOR THE POWER ADAPTER

- The adapter is not safety grounded and may only be used indoors.
- To ensure good ventilation for the adapter, do not place it in tight spaces. To prevent risk of electric shock and fire because of overheating, ensure that curtains and other objects do not prevent adapter ventilation.
- Do not expose the power adapter to direct sunlight, nor use it in ambient temperatures exceeding 40°C.
- Connect the adapter to an easily accessible electrical outlet close to the unit.
- The adapter is in standby mode when the power cord is connected. The primary circuit is always active when the cord is connected to the power outlet. Pull out the cord to completely disconnect the adapter.
- In the EU, only use CE approved power cords.

RESTART

- For a complete restart of the device, wait for at least 30 seconds after turning it off before turning it on again.

TABLE OF CONTENTS

1. INTRODUCTION	10
1.1 CONVENTIONS IN THIS MANUAL.....	10
2. THE DIGITONE II	11
3. PANEL LAYOUT AND CONNECTORS	12
3.1 FRONT PANEL	12
3.2 REAR CONNECTORS.....	14
3.3 SETTING UP AND STARTING THE DIGITONE II	14
4. DIGITONE II SOUND ARCHITECTURE	15
4.1 AUDIO VOICES	15
4.2 EFFECTS	15
4.2.1 SEND EFFECTS.....	15
4.2.2 MASTER EFFECTS.....	15
5. OVERVIEW OF THE DIGITONE II DATA STRUCTURE	16
5.1 +DRIVE	16
5.2 DATA STRUCTURE.....	16
5.2.1 PROJECT	16
5.2.2 PATTERNS	16
5.2.3 PRESETS	16
5.3 ABOUT THE TRACKS	16
5.3.1 AUDIO TRACKS AND MACHINES	16
5.3.2 MIDI TRACKS.....	17
5.3.3 EDITING THE TRACKS.....	17
6. INTERACTING WITH THE DIGITONE II	18
6.1 SCREEN NAVIGATION	18
6.2 PARAMETER EDITING	18
6.2.1 PARAMETER VALUE JUMP	19
6.2.2 CONTROL ALL	19
6.2.3 [FUNC] KEY PRESS COMBINATIONS	19
6.3 QUICK SCROLLING	19
6.4 COPY, CLEAR, AND PASTE.....	19
6.5 THE NAMING SCREEN	19
6.5.1 POP-UP NAMING.....	19
6.6 OVERBRIDGE.....	20
6.7 CLASS COMPLIANT DEVICE	20
6.8 BACKING UP THE DIGITONE II.....	20
6.8.1 BACKING UP PROJECTS, PRESETS	20
6.8.2 TRANSFERRING BACKED UP FILES TO YOUR ELEKTRON DEVICE	21
7. QUICK START	22
7.1 SELECTING AND PLAYING THE PRESETS	22
7.2 PLAYING THE FACTORY PRESET PATTERNS.....	22
7.3 USING KEYBOARD MODE	22
7.4 USING MUTE MODE.....	22
7.5 TEMPO AND METRONOME.....	23
7.5.1 TEMPO	23
7.5.2 METRONOME	23
7.6 EDITING PARAMETERS	23

8. DIGITONE II CONTROLS	24
8.1 TRIG KEYS	24
8.2 ROTARY ENCODERS	24
8.3 KEY BEHAVIOR	24
8.4 MIDI NOTES	24
8.5 MODES	24
8.5.1 KEYBOARD MODE	24
8.5.2 KEYBOARD SETUP MENU	24
8.5.3 MUTE MODE	25
8.5.4 TRIG MODE	26
9. PATTERNS, KITS AND PRESETS	28
9.1 THE +DRIVE LIBRARY AND THE POOL	28
9.1.1 ADDING PRESETS TO THE POOL	28
9.2 PRESET/KIT MENU	29
9.2.1 LOAD (PRESET)	29
9.2.2 SAVE (PRESET)	29
9.2.3 MANAGE (PRESET)	30
9.2.4 POOL	31
9.2.5 LOAD (KIT)	31
9.2.6 SAVE (KIT)	32
9.2.7 MANAGE (KIT)	32
9.3 PLAYING A PRESET	33
9.3.1 PLAYING A PRESET WITH AN EXTERNAL MIDI UNIT	33
9.4 EDITING A PRESET	33
9.5 SAVING A PRESET	34
9.6 THE SETUP MENU	34
9.6.1 KIT	34
9.6.2 TRACK	35
9.7 ARPEGGIATOR MENU	38
9.7.1 MODE	38
9.7.2 SPEED	38
9.7.3 RANGE	38
9.7.4 N.LEN	38
9.7.5 LEN	38
9.7.6 OFS	38
10. THE SEQUENCER	39
10.1 PATTERN OPERATIONS	39
10.1.1 SELECTING BANK AND PATTERN	39
10.1.2 PATTERN CONTROL	39
10.1.3 CHAINS	39
10.2 EDITING A PATTERN	40
10.2.1 TRIG TYPES	40
10.3 GRID RECORDING MODE	41
10.3.1 NOTE EDIT MENU	41
10.4 LIVE RECORDING MODE	42
10.5 STEP RECORDING MODE	43
10.6 SEQUENCER MENU (EUCLIDEAN MODE)	44
10.7 VOICE SETUP MENU	45
10.8 MICRO TIMING	46
10.9 RETRIGS	46
10.10 QUANTIZE MENU	46

10.11 PAGE SETUP MENU	46
10.11.1 PER PATTERN MODE	46
10.11.2 PER TRACK MODE	47
10.12 SEQUENCER FEATURES	48
10.12.1 PARAMETER LOCKS	48
10.12.2 PRESET LOCKS	48
10.12.3 TRIG CONDITIONS AND CONDITIONAL LOCKS	49
10.12.4 FILL MODE	50
10.12.5 COPY, PASTE AND CLEAR OPERATIONS	50
10.12.6 TEMPORARY SAVE AND RELOAD PATTERN COMMANDS	50
10.12.7 TRACK TRANSPOSE	51
10.12.8 PATTERN TRANSPOSE	51
10.12.9 SELECTED TRACKS TRANSPOSE	51
10.13 SONG MODE	51
10.13.1 THE SONG EDIT SCREEN	51
10.13.2 CREATING AND EDITING A SONG	52
10.13.3 PLAYING A SONG	53
10.14 PERFORM KIT MODE	53
10.14.1 PERFORM KIT MODE ACTIONS	54
11. TRACK PARAMETERS	55
11.1 EDITING THE TRACK PARAMETERS	55
11.2 TRIG PAGE 1	55
11.3 TRIG PAGE 2	56
11.4 SYN PAGES	57
11.5 FLTR PAGE 1	57
11.6 FLTR PAGE 2	57
11.7 AMP PAGE	58
11.8 FX PAGE	60
11.9 MOD PAGE 1	61
11.10 MOD PAGE 2	62
11.11 MOD PAGE 3	62
12. FX AND MIXER PARAMETERS	63
12.1 EDITING THE SEND FX AND MIXER PARAMETERS	63
12.2 DELAY	63
12.3 REVERB	64
12.4 CHORUS	65
12.5 COMPRESSOR	65
12.6 INTERNAL MIXER PAGE 1	67
12.7 INTERNAL MIXER PAGE 2	67
12.8 FX MIXER	68
12.9 EXTERNAL MIXER	68
13. SETTINGS MENU	70
13.1 PROJECT	70
13.1.1 LOAD PROJECT	70
13.1.2 SAVE PROJECT AS	70
13.1.3 MANAGE PROJECTS	70
13.2 SONG	71
13.2.1 RENAME	71
13.2.2 CLEAR	71
13.2.3 LOAD	71

13.2.4 SAVE TO PROJ	71
13.3 PATTERN MENU	71
13.3.1 RENAME	71
13.3.2 CLEAR	71
13.3.3 SAVE TO PROJ	71
13.3.4 RELOAD FROM PROJ	72
13.4 MIDI CONFIG	72
13.4.1 SYNC	72
13.4.2 PORT CONFIG	72
13.4.3 CHANNELS	74
13.5 SYSEX DUMP	74
13.5.1 SYSEX SEND	74
13.5.2 SYSEX RECEIVE	75
13.6 AUDIO ROUTING	75
13.6.1 TO MAIN	75
13.6.2 TO SEND FX	75
13.6.3 USB IN	76
13.6.4 USB OUT	76
13.6.5 INT TO MAIN	76
13.6.6 USB TO MAIN [dB]	76
13.6.7 PRE/POST FADER	76
13.7 PERSONALIZE	76
13.7.1 LED INTENSITY	76
13.7.2 LED BACKLIGHT	76
13.7.3 REMEMBER SUBPAGE	77
13.7.4 U/D KEY MODE	77
13.7.5 PAGE AUTOCOPY	77
13.7.6 NOTE PARAM	77
13.8 SYSTEM	77
13.8.1 USB CONFIG	77
13.8.2 OS UPGRADE	78
13.8.3 FORMAT +DRIVE	78
13.8.4 MASTER TUNE	78
14. STARTUP MENU	79
14.1 TEST MODE	79
14.2 EMPTY RESET	79
14.3 FACTORY RESET	79
14.4 OS UPGRADE	79
14.5 EXIT	79
15. SETUP EXAMPLES	80
15.1 DIGITONE II WITH A MONOPHONIC BASS MACHINE	80
15.3 CONTROLLING A SYNTHESIZER USING THE MIDI TRACKS	80
16. KEY COMBINATIONS	82
17. TECHNICAL INFORMATION	85
18. CREDITS AND CONTACT INFORMATION	86
APPENDIX A: MACHINES	87
A.1 ASSIGNING MACHINES TO THE ACTIVE TRACK	87
A.2 SYN MACHINES	87

A.2.1 FM TONE	87
A.2.2 FM DRUM	91
A.2.3 WAVETONE	94
A.2.4 SWARMER	96
A.2.5 MIDI	97
A.3 FLTR MACHINES	100
A.3.1 MULTI-MODE	100
A.3.2 LOWPASS 4	101
A.3.3 LEGACY LP/HP	101
A.3.4 COMB-	102
A.3.5 COMB+	102
A.3.6 EQUALIZER	103
APPENDIX B: THE FM TONE SYNTHESIS	105
B.1 OVERVIEW	105
B.2 OPERATORS	105
B.3 ALGORITHMS	106
B.4 FM RATIOS	106
B.5 OPERATOR ENVELOPES	107
B.6 HARMONICS	108
B.7 SYN PAGE 1 PARAMETERS OVERVIEW	110
APPENDIX C: MIDI	111
C.1 TRACK PARAMETERS	111
C.2 TRIG PARAMETERS	111
C.3 SOURCE PARAMETERS	111
C.4 FILTER PARAMETERS	112
C.5 AMP PARAMETERS	112
C.6 EUCLIDEAN SEQUENCER PARAMETERS	113
C.7 FX PARAMETERS	113
C.8 MOD PARAMETERS	113
C.9 SEND FX PARAMETERS	114
C.10 MIXER PARAMETERS	115
C.11 VAL PARAMETERS	115
C.12 MISC PARAMETERS	116
APPENDIX D: LFO MODULATION DESTINATIONS	117
APPENDIX E: KEYBOARD SCALES	118
INDEX	119

1. INTRODUCTION

To get the most out of your Digitone II, we recommend that you read this manual in its entirety.

1.1 CONVENTIONS IN THIS MANUAL

We have used the following conventions throughout the manual:

- Key names are written in upper case, bold style and within brackets. For instance, the key labeled “FUNC” on the main panel is written as **[FUNC]**.
- Knobs are written in upper case, bold, italic letters. For instance, the knob “Level/Data” is called ***LEVEL/DATA***.
- Menu names are written in upper case letters. The SETTINGS menu is an example of that.
- Parameter names and certain menu options where settings can be made or actions performed are written in bold, upper case letters. For example, **VOL**.
- Upper case letters are used for parameter setting alternatives. For example, OFF.
- Messages visible on the screen are written in upper case letters with quotation marks. For example, “QUANTIZE LIVE REC”.
- LED indicators like the Page LEDs are written like this: <PAGE>.

The following symbols are used throughout the manual:



Important information that you should pay attention to.



A tip that will make it easier for you to interact with the Digitone II.

2. THE DIGITONE II

We're delighted to present to you Digitone II. It's the latest creature in Elektron's history of digital products with an FM synthesis heart. But for this one, FM is only half the story.

Let's rewind a touch. Of course, it is a successor to the wonderful original Digitone, itself a descent into deciphering and modernizing FM synthesis. Digitone left us pondering. Could we go bigger while maintaining the streamlined approach that fits these boxes so well? Could we go deeper while ensuring the joy of sound design only got stronger? These were reflections that opened up all manner of exciting avenues, and was an easier idea to posit than it was to actualize. But it unlatched a door that we couldn't and frankly didn't want to shut. To be honest, the prospect excited the heck out of us.

With Digitone II, we dove into the FM rabbit hole and dug up new ways to access that contrary combination of metallic, organic, punchy bliss. But this Device doesn't stop there. We tuned into multiple additional forms of digital synthesis and brought them into proceedings, meaning there is a huge variety of melodic and percussive options at your disposal. It is a multi-machine, many-realm-reaching behemoth.

Our goal was to have something ripe for exploration - capable of impressive sound sculpting but that just demands to be played and enjoyed. And if that sounds up your alley we think you're in for a proper adventure. Every single time you dive in. If you haven't done so already, flick the power switch and get set to pull your sound through the prism and into a spectrum of dazzling tones and timbres.

Sincerely,

The Elektron Team

3. PANEL LAYOUT AND CONNECTORS

3.1 FRONT PANEL

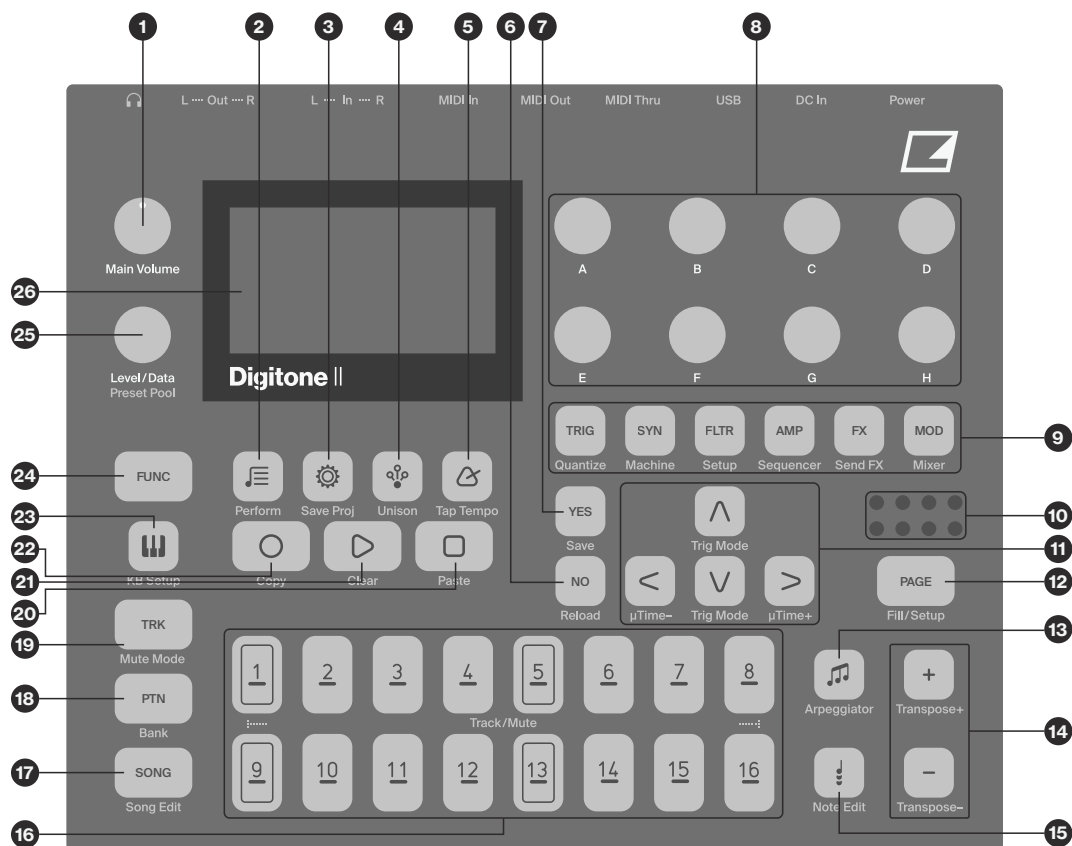

1. **MAIN VOLUME** sets the volume for the main outputs and the headphones output.
2. **[PRESET/KIT]** opens PRESET/KIT menu where you manage presets and kits. The secondary function accesses the PERFORM KIT mode.
3. **[SETTINGS]** opens the SETTINGS menu that contains the management of projects, MIDI configuration, and the System settings. The secondary function saves the current project.
4. **[VOICE SETUP]** opens the VOICE menu where you handle the track's voice allocation. The secondary function toggles unison on/off.
5. **[TEMPO]** opens the TEMPO menu where you can adjust the global/pattern tempo and also adjust the swing. The secondary function makes it possible to tap the tempo.
6. **[NO]** key. Used for exiting an active menu, backing one step and negating. The secondary function is a reload from the temporary save of the active pattern.
7. **[YES]** key. Used for entering sub-menus, selecting and confirming. The secondary function is a temporary save of the active pattern.
8. **DATA ENTRY** knobs **A-H**. Used for setting parameter values. Press and turn the knobs to change values in larger increments.
9. **[PARAMETER]** keys access the PARAMETER pages of the active track. The color of the keys indicates if the page is active (red/turquoise) or inactive (off).
 - **[TRIG PARAMETERS]** accesses parameters such as **NOTE**, **VELOCITY**, and other trig related parameters. The secondary function accesses the PRESET SETUP menu.
 - **[SYN]** accesses the SYN pages. Here you can find parameters related to the SYN machines. For MIDI tracks this page has parameters such as **CHANNEL**, **PROGRAM**, and **AFTERTOUCH**.
 - **[FLTR]** accesses the FILTER pages. Here are the parameters for the base-width and multimode filters. On MIDI tracks you find the CC value and select settings for track 1-8 here. The secondary function accesses the SETUP menu..

- **[AMP]** takes you to the AMP page, where you find parameters for the amplitude envelope and effect sends. On MIDI tracks you find the CC value and select settings for track 1–8 here. The secondary function access the parameters for the Euclidean sequencer.
 - **[FX]** takes you to the FX pages, where you find parameters for the bit reduction, overdrive, sample rate reduction, and effect sends levels. The secondary page accesses the parameters for the send effects.
 - **[MOD]** accesses the LFO parameters for the active track. The secondary function accesses the MIXER pages.
10. The <PATTERN PAGE> LEDs indicate how many pattern pages the active pattern consists of and which pattern page is currently active. The LED flashes on the pattern page currently playing.
 11. The **[ARROW]** keys. Used for navigation and for setting parameter values. In menus, they are called **[UP]**, **[DOWN]**, **[LEFT]**, and **[RIGHT]**.
 12. **[PAGE]** selects the active pattern page, if the pattern has more than 16 steps. The secondary function accesses the SCALE menu. This key also activates FILL mode (when GRID RECORDING mode is not active).
 13. **[ARPEGGIATOR]** opens the ARPEGGIATOR menu. The secondary function toggles the arpeggiator on/off.
 14. **[+]/[-]** are used for transposing patterns, tracks and trigs. The secondary function transposes the active track.
 15. **[NOTE EDIT]** opens the NOTE EDIT menu where you can view, edit and add notes and change note related settings such as note value, length, velocity and timing.
 16. **[TRIG]** keys are used for entering or removing sequencer trigs, and parameter locks, in combination with the **DATA ENTRY** knobs. They are also used to select a track, bank, pattern, and song in combination with the **[TRK]**, **[PTN]**, and **[SONG]** keys. The **[TRIG]** keys are also used as a keyboard in KEYBOARD mode. The secondary function is to Quick Mute tracks.
The **[TRIG]** keys lights indicate trigs on the sequencer by lit red keys, while flashing red or yellow keys indicates parameter locks, in GRID RECORDING and STEP RECORDING mode. When a pattern is playing, or when LIVE RECORDING is enabled, a light “runs” along the 16 steps of the sequencer across all (up to eight) pages at the set tempo.
 17. **[SONG]** selects song 1–16 in combination with the **[TRIG 1–16]** keys. The secondary function accesses the Song edit screen.
 18. **[PTN]** selects the bank and pattern in combination with the **[LEFT]/[RIGHT]** and **[TRIG 1–16]** keys. The secondary function opens Bank selection.
 19. **[TRK]** key. Press **[TRK]** + one of the **[TRIG]** keys to select a track for editing. The secondary function accesses the MUTE mode.
 20. **[STOP]** stops playback. The secondary function is a paste operation.
 21. **[PLAY]** starts the sequencer playback. Pressing **[PLAY]** a second time pauses playback. The secondary function is a clear operation.
 22. **[RECORD]** key. Activates/deactivates GRID RECORDING mode. Press **[RECORD]** + **[PLAY]** and then to activate LIVE RECORDING mode. **[RECORD]** + **[STOP]**, to activate STEP RECORDING mode. The secondary function is a copy operation.
 23. **[KEYBOARD]** toggles KEYBOARD mode on/off. The secondary function opens the KEYBOARD SETUP menu where you can view and edit settings such as scale, root note, and keyboard fold.
 24. **[FUNC]** key. Press and hold **[FUNC]**, and then press another key to access the secondary function of that key. The turquoise text on the Digitone II front panel shows the keys secondary functions.
 25. **LEVEL/DATA** sets the overall volume level of the active track. It is also used for setting parameters and scrolling through lists. The secondary function opens the PRESET MANAGER. This knob is also used to open the PRESET POOL when adding preset locks.
 26. Screen.

3.2 REAR CONNECTORS

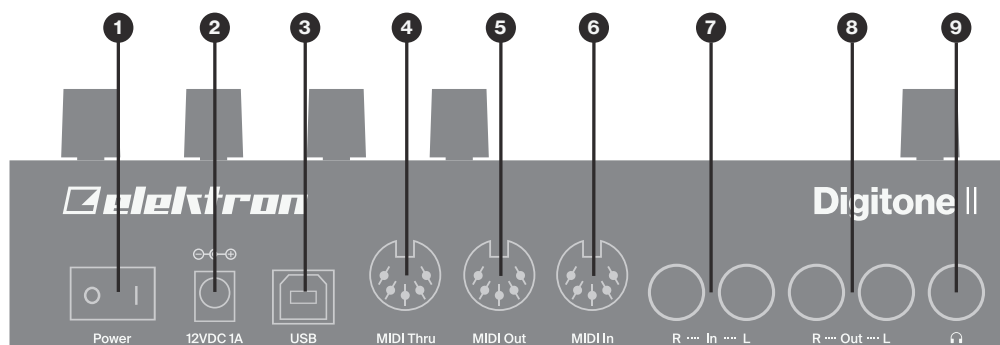

1. **POWER** Switch for turning the unit on and off.
2. **DC In** Input for power supply. Use the included PSU-3c power adapter, connected to a power outlet.
3. **USB** For connecting the unit to a computer. For MIDI-control or Overbridge use. Use the included A to B USB 2.0 connector cable to connect to a computer host.
4. **MIDI THRU/SYNC B**, Forwards data from MIDI IN. Can also be configured to send DIN sync to legacy instruments. Use a standard MIDI cable to connect another MIDI device in the chain.
5. **MIDI OUT/SYNC A**, MIDI data output. Can also be configured to send DIN sync to legacy instruments. Use a standard MIDI cable to connect to MIDI In of an external MIDI device.
6. **MIDI IN**, MIDI data input. Use a standard MIDI cable to connect to MIDI Out of an external MIDI device.
7. **INPUT L/R**, Audio inputs used for external sources for audio processing. Use either a 1/4" (Tip/Ring/Sleeve) phone plug (balanced connection) or a 1/4" mono phone plug (unbalanced connection).
8. **OUTPUT L/R**, Main audio outputs. Use either a 1/4" (Tip/Ring/Sleeve) phone plug (balanced connection) or a 1/4" mono phone plug (unbalanced connection).
9. **HEADPHONES**, Audio output for stereo headphones. Use 1/4" Tip/Ring/Sleeve phone plug.

3.3 SETTING UP AND STARTING THE DIGITONE II

Make sure you place the Digitone II on a stable support, such as a sturdy table, with sufficient space for the cables. Make sure to switch off all devices before you connect the Digitone II to other devices.

1. Plug the supplied DC adapter into a power outlet and connect the small plug to the 12 V DC In on the Digitone II.
2. Connect OUTPUT L/R from the Digitone II to your mixer or amplifier. or use headphones plugged in to the HEADPHONES jack.
3. To control the Digitone II from a computer, connect a USB cable between the computer and the USB connector of the Digitone II.
4. If you want to use MIDI to control the Digitone II, connect the MIDI OUT port of the device you wish to send data from to the MIDI IN port of the Digitone II. The MIDI THRU port duplicates the data arriving at the MIDI IN port so that it can forward data to other MIDI units. If you want to use Digitone II to control other devices, connect the MIDI OUT port of the Digitone II to the MIDI IN port of the of the device you want to control.
5. Connect an audio source to INPUT L/R or via USB if you want to process audio from external sources.
6. Switch on all units. Press the POWER switch located at the back of the Digitone II to switch it on.

4. DIGITONE II SOUND ARCHITECTURE

The illustrations below show the Digitone II internal sound architecture for its 16 audio voices.

4.1 AUDIO VOICES

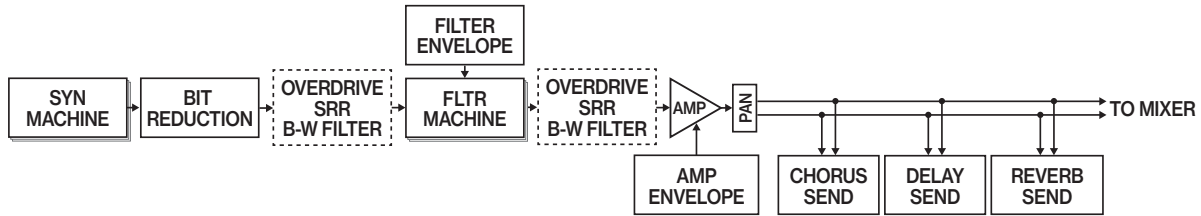

The overdrive, sample rate reduction, and the base-width filter can all individually be routed before or after the filter machine.

4.2 EFFECTS

4.2.1 SEND EFFECTS

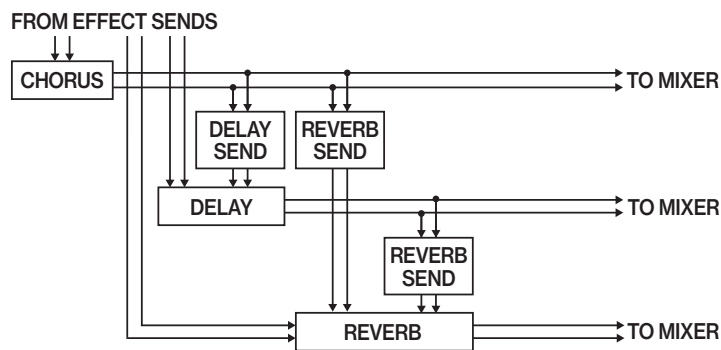

4.2.2 MASTER EFFECTS

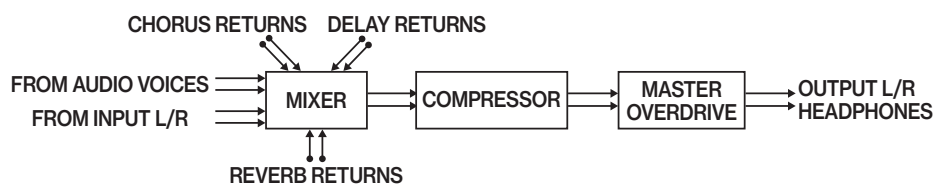

5. OVERVIEW OF THE DIGITONE II DATA STRUCTURE

The illustration below outlines the Digitone II's data structure.

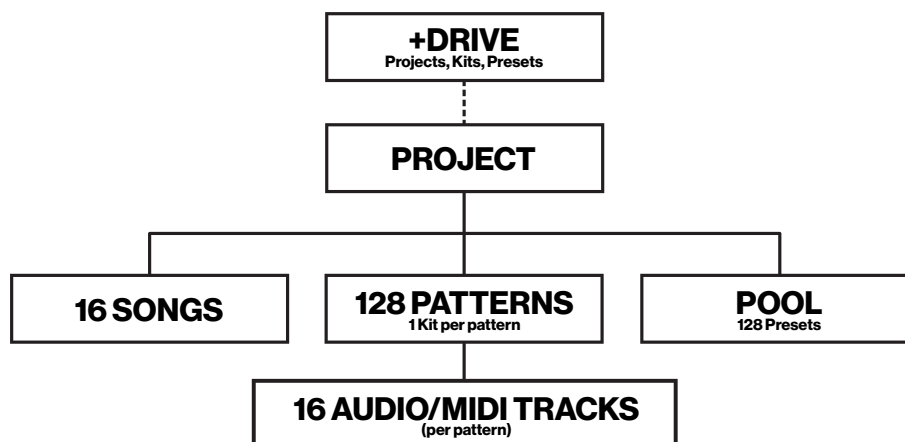

5.1 +DRIVE

The +Drive is a non-volatile RAM memory capable of storing up to 128 projects. The +Drive also holds +Drive preset library, with the capacity of storing 2048 presets. Every project has access to these presets.

5.2 DATA STRUCTURE

5.2.1 PROJECT

A project contains 128 patterns. The project also stores general settings and states. The currently loaded project becomes the active working state of the Digitone II. From here it is possible to edit the patterns and presets of the project. Every time the Digitone II is switched on, it boots to the active working state, the active project. Projects are saved, loaded and managed in the SETTINGS menu. For more information, please see "13. SETTINGS MENU" on page 70.

5.2.2 PATTERNS

The patterns are the primary data container for the Digitone II. 16 patterns are available for each of the eight banks, which means that 128 patterns are available for each project. A pattern contains up to 16 presets (one for each synth track), sequencer data like trigs and parameter locks. It also contains the settings on the TRIG page and BPM, length, swing and time signature settings. The pattern also contains all the parameter settings for the four MIDI tracks. For more information, please see "10. THE SEQUENCER" on page 39.

5.2.3 PRESETS

A preset is a collection of the synth track settings in the SYN1, SYN2, FLTR, AMP, and LFO PARAMETER pages. Presets can be stored either in the preset pool of the active project or the +Drive preset library. The preset pool holds up to 128 presets and the +Drive library holds up to 2048 presets. You can use the PRESET MANAGER to manage sounds. For more information, please see "9. PATTERNS, KITS AND PRESETS" on page 28.



A preset imported to a pattern, becomes an independent copy of the preset on the +Drive and is not linked to the original preset on the +Drive. Instead, it becomes a part of the pattern.

5.3 ABOUT THE TRACKS

The Digitone II sequencer has 16 tracks that can be either an audio track or a MIDI track.

5.3.1 AUDIO TRACKS AND MACHINES

Any of the sixteen tracks can be used as an audio track. This is the default track setting. Each synth track contains one preset. The preset contains the settings in the PARAMETER pages (SYN, FLTR, AMP, FX, and MOD) together with the settings in the PRESET SETUP menu and the ARPEGGIATOR menu. A track that contains any other SYN machine than the MIDI machine is considered an audio track.

A machine is a module within the Digitone II with specific functionality. A machine can be switched out for another machine in the same category. For example different audio synthesis playback engines (SYN machines) or a selection of filters (FLTR machines). Every machine has a specific set of parameters tailored to give you the most relevant and useful sound-shaping possibilities for that particular machine. For more information, please see “APPENDIX A: MACHINES” on page 87.

5.3.2 MIDI TRACKS

Any of the 16 tracks can be used as a MIDI track. They are used to control external, MIDI equipped, gear. Each MIDI track can trigger a chord of up to four notes with adjustable parameters such as velocity and length, control pitch bend and aftertouch, as well as sixteen freely assignable MIDI control change parameters (MIDI CCs). For more information, please see “A.2.5 MIDI” on page 97. Any MIDI channel can be assigned to a MIDI track and several tracks can share the same channel. If several tracks are assigned to the same MIDI channel the track with the lowest number has priority in case of parameter conflicts.

The MIDI tracks function almost the same way as the audio tracks. Parameter locks, LFO modulation, copy and paste commands are available. Each MIDI track also features micro timing, individual track length and time signature settings. The main difference is that the MIDI tracks do not generate any sound and the sequencer data is instead transmitted through the MIDI OUT or USB ports.

To use a track as a MIDI track, you must first assign a MIDI machine to it.

1. Press **[FUNC] + [SYN]** to open the MACHINE menu.
2. Use **[LEFT]/[RIGHT]** to navigate to the SYN machine category.
3. Use **[UP]/[DOWN]** to select the MIDI machine, and then press **[YES]** to assign it to the track.

5.3.3 EDITING THE TRACKS

The six **[PARAMETER]** keys open the corresponding parameter page group which is where you edit the tracks.

- The TRIG page contains different parameters such as **NOTE**, **VELOCITY**, and other trig related parameters.
- The SYN page hosts the parameters that controls various parameters of the synthesis engines. For MIDI tracks, this page contains parameters such as **CHANNEL**, **PROGRAM**, and **AFTERTOUCH**.
- On the FLTR page, you find parameters for the selected filter/EQ machine and the base-width filter on audio tracks. On MIDI tracks you find the CC value settings and the CC select settings for CC parameters 1–8 here.
- The AMP page for audio tracks hosts parameters for the amplitude envelope. On MIDI tracks you find the CC value settings and the CC select settings for CC parameters 9–16 here.
- The FX page contains the Bit Reduction, Overdrive, Sample Rate Reduction, and the send effects send levels for the audio tracks, The FX page is empty for MIDI tracks.
- The MOD page hosts LFO parameters for the active track.

Use the DATA ENTRY knobs A-H to edit the corresponding parameters. Press and turn a knob to adjust its parameter in larger increments. Use the **[UP]/[DOWN]** keys to cycle through the parameter group's pages. You can also press a **[PARAMETER]** key repeatedly to cycle through the parameter pages in that group. Press and hold a **[PARAMETER]** key to see the values for all parameters on that page. For more information, please see “11. TRACK PARAMETERS” on page 55, and “APPENDIX A: MACHINES” on page 87.

6. INTERACTING WITH THE DIGITONE II

The screen shows all the information needed for real-time interaction and editing on the Digitone II. The eight **DATA ENTRY** knob parameters shown will vary depending on the given situation. Below is the main interface screen of the MOD page.

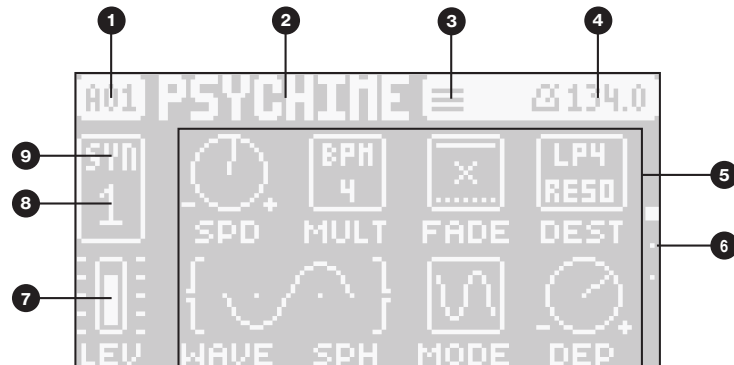

1. The current bank and pattern.
2. The current pattern name.
3. The selected TRIG mode.
4. The current tempo.
5. Eight track parameters. They show what the **DATA ENTRY** knobs control and their current parameter values.
6. Parameter page indicator. Indicates the number of pages for the selected parameter section and which page is currently selected.
7. The main level setting of the active track. Use the **LEVEL/DATA** knob to change the volume setting.
8. The current active track.
9. Track type. Audio (SYN) track or MIDI (MID) track.



The Digitone II features a screen saver that dims the screen after 5 minutes of inactivity and turns off the screen after 60 minutes. Press any key or move any controller to wake the screen.

6.1 SCREEN NAVIGATION

Use the [ARROW] keys [UP], [DOWN], [LEFT] or [RIGHT] to navigate menus or sub-menus. The **LEVEL/DATA** knob can be used to scroll through menus and lists quickly.

[YES] is used to affirm, select, enter sub-menus and tick/untick boxes.

[NO] is used to negate, deselect or go back one or more steps.



When in a menu or sub-menu, the [NO] key can be used to go back, one step at a time, all the way to the main screen.

6.2 PARAMETER EDITING

The **DATA ENTRY** knobs are used to change the values of the track parameters. The positions of the parameters on the screen correspond to the physical locations of the knobs on the front panel. Some of the parameters on the screen tell you what **DATA ENTRY** knob controls that particular parameter. For example "(E)" in the PAGE SETUP menu.

- The parameters are adjusted in larger increments if you press down the **DATA ENTRY** knob while turning it. This makes it quicker to sweep through the whole parameter range.
- Press **DATA ENTRY** knob + [NO] to reset the parameter to the default value.
- Press [PARAMETER] key + [PLAY] to reset all the parameters in the selected parameter page to default values.
- Press and hold a [PARAMETER] key to see the values for all parameters on that page.

6.2.1 PARAMETER VALUE JUMP

Pressing [FUNC] while editing certain parameters will make the parameter values jump to appropriate positions. The NOTE parameter, for example jumps between octaves and the delay time jumps between BPM related tempo settings.

6.2.2 CONTROL ALL

If you press and hold [TRK] and change a parameter setting, this change will affect this parameter in all the audio tracks in the pattern. Press [NO] before you release [TRK] to revert the parameter changes. In the SETUP menu, you have the possibility to select which tracks should be affected by the control all functionality. For more information, please see “9.6.1 KIT” on page 34.



- Control all operations also affects the active track, whether it is selected to be affected or not.
- The control all functionality is not available for the MIDI tracks.

6.2.3 [FUNC] KEY PRESS COMBINATIONS

The standard way to use the [FUNC] key in combination with other keys, is to press and hold [FUNC] and then press the second key in the combination.

6.3 QUICK SCROLLING

Scroll through menus using the LEVEL/DATA knob. Quick scrolling is possible on many menus. Press [FUNC] + the [UP] or [DOWN] keys to move the cursor one menu page.

6.4 COPY, CLEAR, AND PASTE

Copy, clear and paste commands are available in a lot of contexts. Pressing [FUNC] + [RECORD] to copy. Press [FUNC] + [STOP] to paste. Press [FUNC] + [PLAY] to clear. Paste and clear operations are undone by repeating the key press combination. Please see the different sections in the manual for more information on when these commands are available. For more information, please see “16. KEY COMBINATIONS” on page 82.



The copy clipboard can only hold one item at a time. When you perform a copy command, the item copied replaces any earlier copied items. For example, you can not have both a trig and a pattern copied at the same time.

6.5 THE NAMING SCREEN

The naming method is identical for the various naming situations that appear when you save presets, projects et cetera.



The [LEFT] and [RIGHT] arrow keys are used to navigate between the characters. Turning the LEVEL/DATA knob or pressing the [UP] or [DOWN] arrow keys selects the characters. [FUNC] + [NO] erases characters. [FUNC] + [YES] inserts space. Press [SETTINGS] to create a random name. Press and hold [FUNC] to access the Pop-up Naming menu.

6.5.1 POP-UP NAMING

A convenient way of naming is to open a pop-up menu that shows all available letters, symbols, and digits. Press and hold the [FUNC] key when you are on the NAMING screen to access the Pop-up Naming screen.



Keep [FUNC] pressed and use the [ARROW] keys to highlight the character you want to insert. Once there, release [FUNC] to add the character.



Copy, paste, and clear commands are available on the NAMING screen.

6.6 OVERBRIDGE

The Overbridge software enables a tight integration between the Digitone II and a computer DAW software. When using Overbridge, the user interface for the Digitone II presents itself as a plug-in window in your DAW. Access, edit and automate parameters for sound shaping on screen. Always find your device preset parameters in the same state as you left them when you return to your DAW project, with the useful total recall functionality.

Read more about Overbridge use and availability on the Elektron website: <https://www.elektron.se/overbridge/>



Overbridge for Digitone II is still under development and is not currently available.

6.7 CLASS COMPLIANT DEVICE

The Digitone II is a class compliant device (also known as plug-and-play). It means it does not require any extra drivers to connect to your computer or other USB class compliant hosts.

The Digitone II can, therefore, stream audio and MIDI directly over USB to and from supported computers/phones/tablets. It opens up several exciting possibilities of what you can do with your device, for example, record audio from your device directly over USB in your DAW. For more information, please see “13.8.1 USB CONFIG” on page 77.

6.8 BACKING UP THE DIGITONE II

It is always recommended to make regular backups of your data. Backups are also a convenient way to share your projects and presets with other users. To make backups and transfer files to and from your Elektron device, you should use Transfer, a free application that you can download from the Elektron site <https://www.elektron.se/support>. The application is available for both Windows and macOS.

6.8.1 BACKING UP PROJECTS, PRESETS

You can backup your projects and presets from your Elektron device to a computer. Here is the general procedure for how to back up your device:

1. Connect the Elektron device to the computer via USB.
2. Open the Transfer application on your computer, and then select the USB MIDI port(s) for your device on the CONNECTION page, and then click “CONNECT” next to your device under AVAILABLE DEVICES.
3. In Transfer, click the EXPLORE tab to open the EXPLORE page.
4. On the EXPLORE page top left side of the drop-down menu, make sure “MY COMPUTER” is selected.
5. On the top right side, in the drop-down menu, select the type of file you want to transfer.
6. In the window on the right, navigate to the files or folders you want to transfer
7. Drag and drop the files or folders from your device to your preferred location under “MY COMPUTER.”

6.8.2 TRANSFERRING BACKED UP FILES TO YOUR ELEKTRON DEVICE

Use the EXPLORE page in Transfer to transfer previously backed up files to your Elektron device from a computer.

1. Connect the Elektron device to the computer via USB.
2. Open the Transfer application on your computer and then select the USB MIDI port(s) for your device on the Transfer CONNECTION page. Click "CONNECT" next to your device under AVAILABLE DEVICES.
3. In Transfer, click the EXPLORE tab to open the EXPLORE page.
4. On the top right side, in the drop-down menu, select the type of file you want to transfer.
5. On the top left side in the drop-down menu, make sure "MY COMPUTER" is selected.
6. Under "MY COMPUTER," navigate to the files or folders you want to transfer.
7. Drag and drop the files or folders to your preferred location on your device.
8. Depending on what file type you send, you might encounter pop-up windows asking you to decide what files you want to send and how you want to organize them.



It is possible to import Digitone I projects to Digitone II. However, due to changes in the device architecture, the patterns in the projects might not be 100% the same in some cases.

7. QUICK START

This quick start will guide you through some of the basic operations to start using the Digitone II right away. First, connect it as described in section “3.3 SETTING UP AND STARTING THE DIGITONE II” on page 14.

7.1 SELECTING AND PLAYING THE PRESETS

There are a large number of presets in the Digitone II that you can use in your music-making or as starting points for your own sound design.

1. Press **[PRESET/KIT]** to open the PRESET/KIT menu.
2. Select **LOAD (PRESET)** to open the LOAD PRESET MENU
3. Use the **[UP]/[DOWN]** keys or **LEVEL/DATA** to highlight a preset.
4. Press **[KEYBOARD]** and then use the **[TRIG]** keys to play and listen the highlighted preset.
5. Press **[YES]** to load the preset to the active track.

7.2 PLAYING THE FACTORY PRESET PATTERNS

You can find a number of factory preset patterns in the Digitone II. Follow the instructions below to get started exploring your new instrument.

1. Press **[PTN]** and then use the **[LEFT]/[RIGHT]** keys to select bank A. Then press **[TRIG 1]** to select pattern A01.
2. Press **[PLAY]** to listen to pattern A01.
3. Press **[PTN]**, and then press **[TRIG 2]** to cue pattern A02. It will start once pattern A01 has reached its end. Select pattern A03 by pressing **[PTN]**, and then press **[TRIG 3]**, and so on.
4. Press **[STOP]** to stop playback.

7.3 USING KEYBOARD MODE

You can use the **[TRIG]** keys to play any track chromatically.

1. Select the track to play chromatically by pressing **[TRK]** + one of the **[TRIG 1-16]** keys.
2. Press **[KEYBOARD]** to enter KEYBOARD mode. The **[TRIG]** keys will light up in a pattern that resembles an octave of a piano keyboard. Only lit keys are playable.
3. Play the **[TRIG]** keys. The preset will be pitched differently for each of the playable keys. Press **[+]/[-]** to transpose the virtual keyboard up or down one octave.

For more information, please see “8.5.1 KEYBOARD MODE” on page 24.



KEYBOARD mode is an effective way to add musical variety to your tracks. The timbre, tonality and impact of playing a preset chromatically depends on the character of the source preset.

7.4 USING MUTE MODE

You can mute any of the sequencer tracks in this mode. Unlike the KEYBOARD mode, it makes no difference which track is active when this mode is activated. You can access all tracks simultaneously.

1. Make sure a pattern is playing.
2. Press the **[FUNC]** + **[TRK]** key to enter MUTE mode.
3. Press any of the **[TRIG]** keys to mute the corresponding track. Press again to unmute. The light of the **[TRIG]** keys indicates the mute status. Unlit keys are muted tracks. Lit keys are active tracks.

For more information, please see “8.5.3 MUTE MODE” on page 25.

7.5 TEMPO AND METRONOME

Press the [TEMPO] key to open the TEMPO menu.

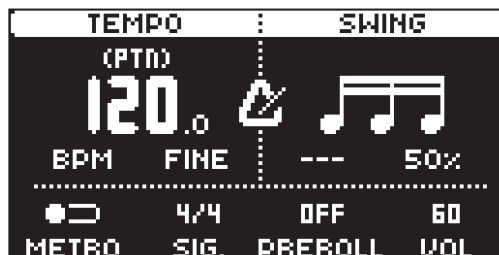

7.5.1 TEMPO

To change the BPM setting, open the TEMPO menu by pressing the [TEMPO] key. Use **DATA ENTRY** knob **A** or **LEVEL/DATA** to change tempo. Pressing the knob while turning it changes the tempo four BPM at a time. Use **DATA ENTRY** knob **B** or [UP] or [DOWN] to change the tempo in decimal steps. You can choose between a tempo for the whole project or use a separate tempo every pattern. Press and hold [FUNC], and then use **DATA ENTRY** knob **E** to switch between these modes. On the main interface screen, you can also press and hold the [ARROW] keys [LEFT] or [RIGHT] to nudge the tempo 10% up or down temporarily. Release the key to revert to the original tempo.

To tap a tempo setting, hold [FUNC] and tap the [TEMPO] key in a steady rhythm. After four consecutive taps the average tempo of the taps will be calculated. By continuing tapping, the average tempo will keep on updating.

When in the TEMPO menu (and with PROJECT tempo mode selected), holding [FUNC] while turning **DATA ENTRY** knob **A** will not change the tempo to the selected value until [FUNC] is released. While doing this, "PREP." flash in the bottom left corner of the screen.



Nudging the tempo is very handy when manually syncing Digitone II to a turntable or an external sound source. Note that you do not need to be in the TEMPO menu to nudge the tempo.

Use **DATA ENTRY** knob **D** to adjust the **SWING** setting of the pattern, to employ a propulsive, rhythmic groove. The swing ratio can be set to 51-80%. The default setting is equal spacing, 50%.

7.5.2 METRONOME

The metronome settings controls the internal metronome of the Digitone II. Use the **DATA ENTRY** knobs to change the settings.

METRO activates/deactivates the metronome.

SIG. controls the note and beat measure of the metronome time signature.

PREROLL controls for how many bars the metronome will sound before the sequencer starts playing. This setting is only relevant when you are in LIVE RECORDING mode.

VOL controls the volume of the metronome click.

7.6 EDITING PARAMETERS

Each track has six PARAMETER page groups that each contain a number of pages. Press [PARAMETER] keys TRIG, SYN, FLTR, AMP, FX, and MOD to access the different PARAMETER page groups. These parameters affect the sound and signal in various ways.

1. Make sure a pattern is playing.
2. Press [TRK] + [TRIG] keys 1-16 to select a track.
3. To change, for example, the cutoff of the filter, press the [FLTR] key to open the FILTER page. The parameter labeled **FREQ** changes the cutoff of the filter. Turn **DATA ENTRY** knob **E** to change the parameter value, and hear how the sound is affected.

Try out the rest of the PARAMETER page parameters to explore a variety of sound shaping possibilities.

8. DIGITONE II CONTROLS

8.1 TRIG KEYS

The **[TRIG]** keys have several uses, including for example, triggering an audio/MIDI track from the active pattern. They can also be used for placing trigs in the RECORDING modes. When pressed in combination with the **[PTN]** and **[SONG]** keys, they select patterns and songs. The **[TRIG]** keys light up to indicate the position of placed trigs and to indicate the selected bank and track.

8.2 ROTARY ENCODERS

The **MAIN VOLUME** is an absolute encoder, spanning roughly 320 degrees from its left extreme to its right extreme. The **LEVEL/DATA** and **DATA ENTRY** knobs (with which you set various parameter values), are relative encoders which may be spun any number of turns. Pressing and turning these encoders will change their associated values at a greater speed.

8.3 KEY BEHAVIOR

As a group, the track selection keys (the **[TRIG]** keys) have radio button functionality, i.e. when a new track is set to be active, the previous one is simultaneously deactivated. Only one track can be selected at a time. Likewise, the group consisting of the six **[PARAMETER]** keys also have radio button functionality.

8.4 MIDI NOTES

Some functions can be triggered by sending MIDI note values from an external MIDI device (a MIDI keyboard or a computer, for example) connected to the Digitone II via a standard MIDI cable or a USB 2.0 A to B connector cable.

MIDI note numbers 0–127 (corresponding to notes C0–G10, the first through to eleventh octaves in the MIDI range) triggers the preset of the active track.

MIDI program change messages 0–127 will select pattern 1–128 (A01–H16) on the Digitone II. Additionally, MIDI CC and NRPN messages can be sent to control various aspects of the Digitone II. For more information, please see “APPENDIX C: MIDI” on page 111.

8.5 MODES

There are several modes of operation on the Digitone II that decides what action the **[TRIG]** keys perform when pressed.

8.5.1 KEYBOARD MODE

Press **[KEYBOARD]** to enter KEYBOARD mode. In this mode, you can play the preset of the active audio track (or send MIDI notes if you have an active MIDI track). With **KB SCALE** set to CHROMATIC and **MODE** set to REGULAR the **[TRIG]** keys will light up in a pattern that resembles an octave of a piano keyboard layout. Only lit keys are playable. Press **[TRK] + [TRIG 1–16]** keys to select the track you want to play.

Press the lit trig keys to play different notes. The range from **[TRIG 9]** key to **[TRIG 16]** key is one octave. The whole note range you can trig is a little more than 10 octaves (C0–G10). You can transpose the keyboard 4 octaves up and 5 octaves down from the middle octave. Press **[+]/[-]** to transpose the virtual keyboard up or down in octave steps. With **U/D KEY MODE** set to KB OCT, you can also press **[UP]/[DOWN]** to transpose the virtual keyboard when you are in KEYBOARD mode. For more information, please see “13.7.4 U/D KEY MODE” on page 77.

Notes triggered can be recorded on the sequencer in LIVE RECORDING mode. Find out how this is done in section “10.4 LIVE RECORDING MODE” on page 42.

Press **[KEYBOARD]** again to exit KEYBOARD mode.



In KEYBOARD mode the color of the **[+]/[-]** keys shows the current octave for the **[TRIG]** keys. White: 1 octave up/down, Yellow: 2 octaves up/down, Orange: 3 octaves up/down, Red: 4 octaves up/down, Dark Red: 5 octaves down.

8.5.2 KEYBOARD SETUP MENU

Press **[FUNC] + [KEYBOARD]** to open the KEYBOARD SETUP menu. Here you get a graphical view of which notes the **[TRIG]** keys play. Press **[+]/[-]** or **[UP]/[DOWN]** to transpose the keyboard up or down an octave. In this menu, you can also set different musical scales, and select the root note of the scale. Use the **DATA ENTRY** knobs to change the settings. Press **[NO]** to exit the menu. Press **[KEYBOARD]** again to exit KEYBOARD mode. The settings are stored in the active pattern.



KB SCALE sets the track's scale. This setting governs which notes are playable on the Digitone II's [TRIG] keys to allow only notes in the set scale. For a list of all selectable keyboard scales, please see "APPENDIX E: KEYBOARD SCALES" on page 118

ROOT NOTE sets the root note for the chosen scale.

KB FOLD When set to ON, **KB FOLD** changes the way the notes are laid out on the [TRIG] keys and how they are played from external MIDI devices. Now all the [TRIG] keys trigger a note. The [TRIG 9] key plays the lowest note of the selected octave, root note and scale. The notes are then played upwards through the scale to [TRIG 16] and then further upwards on [TRIG 1–8]. When a scale contains less than eight notes in an octave, the "remaining" [TRIG] keys on the lower row will play the same notes as the first [TRIG] keys on the upper row. Blue [TRIG] keys signal that they contain notes that are one or more octaves distanced from each other.

In the following example of the whole tone scale [TRIG 15–16] keys play the same notes as the [TRIG 1–2] keys. [TRIG 1] and [TRIG 15] both play a note that is one octave above [TRIG 9]. [TRIG 7] plays a note that is two octaves above [TRIG 9].

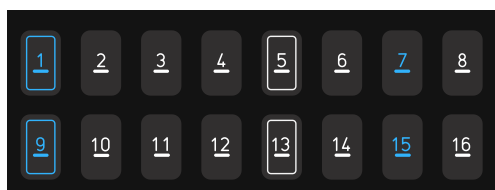

- The active state and settings of the KEYBOARD mode is stored per pattern.
- You can also use an external keyboard to play the active tracks preset chromatically. Connect the keyboard to the Digitone II and configure the external keyboard and the Digitone II MIDI Auto Channel (SETTINGS > MIDI CONFIG > CHANNELS) to the same MIDI channel. Then play the keys on the external keyboard to play the active tracks preset chromatically. You can play the active track's preset chromatically even if the Digitone II is not in KEYBOARD mode.

8.5.3 MUTE MODE

You can use MUTE mode to mute any of the 16 sequencer tracks. Unlike KEYBOARD mode, it makes no difference which track is active when you enter MUTE mode. All tracks are accessed simultaneously. Press any of the [TRIG] keys to mute the corresponding track. Press again to unmute. The color of the [TRIG] keys indicates its tracks mute status. Lit keys signify unmuted tracks. Unlit keys signify muted tracks.

There are two different versions of MUTE mode on the Digitone II:

- **GLOBAL MUTE MODE** In GLOBAL MUTE mode, the muted tracks are muted in all patterns. In this mode, the [TRACK] keys are lit green. If a track with trigs placed on it is muted in GLOBAL MUTE mode, its [TRACK] key blinks green when the pattern plays.
Press [FUNC] + [TRK] to enter GLOBAL MUTE mode.
Press [FUNC] + [TRK] to exit GLOBAL MUTE mode.
- **PATTERN MUTE MODE** In PATTERN MUTE mode, the muted tracks are muted only in the active pattern. In this mode, the [TRACK] keys are lit magenta. If a track with trigs placed on it is muted in PATTERN MUTE mode, its [TRACK] key blinks magenta when the pattern plays.
Press [FUNC] + double-press [TRK] to enter PATTERN MUTE mode.
Press [FUNC] + [TRK] to exit PATTERN MUTE mode.

The GLOBAL MUTE mode settings are saved together with the project. The PATTERN MUTE mode settings are saved together with the pattern.

If a track with trigs placed on it is muted in PATTERN MUTE and GLOBAL MUTE mode, its [TRACK] key blinks magenta in both modes when the pattern plays.

You can also prepare tracks for muting/unmuting before the mute action takes effect. While in any MUTE mode, press and hold [FUNC] and then press the [TRIG] keys corresponding with the tracks you want to mute/unmute. The selected tracks will then be muted/unmuted when you release [FUNC]. At the top of the screen you can see an overview of the mute status for all the tracks. Square = unmuted track, horizontal line = muted track, a plus sign = a track prepared to be unmuted, an X = track prepared to be muted.



- You can also use QUICK MUTE to mute and unmute sequencer tracks. Press and hold [FUNC] and then press the [TRACK] keys to mute or unmute tracks.
- Digitone II remembers the last used version of MUTE mode and will access this one first when you press [FUNC] + [TRK]. This also applies to QUICK MUTE. However, after reboot, it defaults back to GLOBAL MUTE mode.

8.5.4 TRIG MODE

The various TRIG modes affect the functionality of the [TRIG 1-16] keys. Press [FUNC] + [UP] or [DOWN] to select which TRIG mode that should be active. The selected TRIG mode is active for all the tracks. All actions performed using the trig modes can be recorded in LIVE RECORDING mode.



TRACKS

This is the default TRIG mode. In this mode, the [TRIG 1-16] keys triggers the corresponding audio/MIDI tracks.

VELOCITY

In this TRIG mode, the [TRIG 1-16] keys triggers the active track with different amounts of velocity.

- Trig 1 = Velocity 8
- Trig 2 = Velocity 16
- Trig 3 = Velocity 24
- Trig 4 = Velocity 32
- Trig 5 = Velocity 40
- Trig 6 = Velocity 48
- Trig 7 = Velocity 56
- Trig 8 = Velocity 64
- Trig 9 = Velocity 72
- Trig 10 = Velocity 80
- Trig 11 = Velocity 88
- Trig 12 = Velocity 96
- Trig 13 = Velocity 104
- Trig 14 = Velocity 112
- Trig 15 = Velocity 120
- Trig 16 = Velocity 127

RETRIGS

In this TRIG mode, the [TRIG 1-16] keys triggers the active track with different amounts retrig rates.

- Trig 1 = Retrig rate 1/1
- Trig 2 = Retrig rate 1/2

Trig 3 = Retrig rate 1/3
Trig 4 = Retrig rate 1/4
Trig 5 = Retrig rate 1/5
Trig 6 = Retrig rate 1/6
Trig 7 = Retrig rate 1/8
Trig 8 = Retrig rate 1/12
Trig 9 = Retrig rate 1/16
Trig 10 = Retrig rate 1/20
Trig 11 = Retrig rate 1/24
Trig 12 = Retrig rate 1/32
Trig 13 = Retrig rate 1/40
Trig 14 = Retrig rate 1/48
Trig 15 = Retrig rate 1/64
Trig 16 = Retrig rate 1/80

PRESET POOL

In this TRIG mode, the [TRIG 1-16] keys triggers sixteen preset slots in the preset pool. The first page triggers the presets in slots 1-16. Press [PAGE] + [RIGHT] to go to page 2 to trigger the presets in slots 17-32 and so on. Press [PAGE] + [LEFT/RIGHT] to select which slots you wish to trigger. For more information, please see "9.1 THE +DRIVE LIBRARY AND THE POOL" on page 28.



Incoming MIDI note data are mapped to the tracks in different ways depending on the chosen TRIG mode.



The RETRIGS and PRESET POOL trig modes are only supported on audio tracks.

9. PATTERNS, KITS AND PRESETS

The patterns are the primary data container for the Digitone II. Sixteen patterns are available for each of the eight banks, which means that 128 patterns are available for each project. A pattern contains up to 16 presets (one for each track), sequencer data like trigs and parameter locks. It also contains the default settings on the TRIG page and BPM, length, swing and time signature settings.

A kit is a collection of 16 presets, one for every track together with a number of kit related settings. A preset is either an audio track preset or a MIDI track preset. Audio track presets contain all settings from the SYN, FLTR, AMP, FX, and MOD PARAMETER pages, and MIDI track presets contain all settings from the SYN, FLTR, AMP, and MOD PARAMETER pages. Any preset can be assigned to any of the 16 tracks.

A preset or kit that has been imported from the +Drive to a pattern becomes part of the active pattern. Any changes made to a preset/kit will therefore not affect the stored preset/kit. It will only affect the preset/kit in the active pattern. You can export (and in that way save) a preset/kit from the active pattern to the +Drive. For more information, please see “9.2 PRESET/KIT MENU” on page 29.



When a preset or a kit is imported to a pattern, it becomes a copy of the preset/kit on the +Drive and is not linked to the original preset/kit stored on the +Drive. Instead, it fully becomes a part of the pattern.

A pattern contains:

- A kit.
- Sequencer data such as trigs and parameter locks for the 16 tracks.
- The settings on the TRIG page, BPM, length, swing and time signature settings.

A kit contains:

- 16 audio or MIDI track presets.
- LEVEL settings for the audio tracks and the pattern.
- Compressor and Master distortion settings
- Compressor routing and Control all settings
- Send FX settings
- Track layering settings
- Patterns transpose settings

A preset contains:

- The SYN, FLTR, AMP, FX and MOD PARAMETER pages settings for the audio track. Or, in the case of MIDI presets, the SYN, FLTR, AMP, and MOD PARAMETER pages settings for the MIDI track.

9.1 THE +DRIVE LIBRARY AND THE POOL

The +Drive library can hold up to 2048 presets (256 presets in each bank A-H) that are available to all projects. The kits are also stored here.

Presets can be loaded to a pattern from either the +Drive library or the pool (Project RAM) of the active project. The difference between the two is that the +Drive library has the capacity of 2048 presets, available to all projects, while the pool is a part of a projects internal memory and limited to 128 presets. The primary benefit of presets loaded to the pool is the possibility for them to be preset locked. This feature is not available for the presets in the +Drive library. For more information, please see “10.12.2 PRESET LOCKS” on page 48.

9.1.1 ADDING PRESETS TO THE POOL

You must first add presets to the pool to be able to perform preset locks.

1. Press **[PRESET/KIT]** to open the PRESET/KIT menu.
2. Select (PRESET) **MANAGE**, and then press **[YES]** to open the PRESET MANAGER.
3. Select the presets you want to add to the pool by highlighting them and pressing **[YES]**.
4. Press **[LEFT]** to open the PRESET SORTING menu.
5. Select **ADD TO PRESET POOL** and then press **[YES]**.



MIDI presets can not be added to the preset pool

9.2 PRESET/KIT MENU

Press **[PRESET/KIT]** to open the PRESET/KIT menu. Here you manage presets (both on the +Drive and in the pool) and kits. Use the **[ARROW]** keys and **LEVEL/DATA** to navigate the menu. Press **[YES]** to select a menu item. Press **[NO]** to exit the menu.

9.2.1 LOAD (PRESET)

Use the **[ARROW]** keys or **LEVEL/DATA** to select a preset. Press **[YES]** to load the preset to the active track. Press **[TRK] + [TRIG 1-16]** to change active track. Press the track's **[TRIG]** key to preview the highlighted preset before you load it. You can also press **[FUNC] + [YES]** to preview the preset. Press **KEYBOARD**, and then use the **[TRIG]** keys to preview the selected preset in the selected scale.

Press **[LEFT]** to access the SORTING menu. Press **[YES]** to execute the commands. Press **[NO]** or the **[RIGHT]** arrow key to exit the menu.

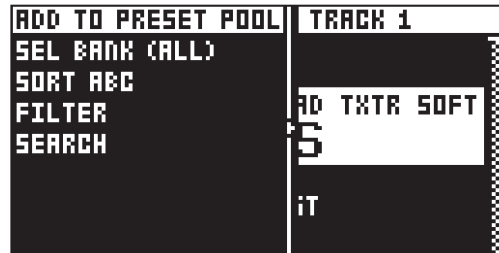

ADD TO PRESET POOL adds the selected preset to the pool of the active project.

SEL BANK (ALL) opens the Preset bank selector. The currently selected bank is shown in parenthesis. Use the **[TRIG 8-16]** keys, the **[ARROW]** keys, or **LEVEL/DATA** to select bank.

SORT ABC / SORT 123 toggles between if the presets are sorted in alphabetical order or by slot number.

FILTER opens a list where presets can be arranged according to tags. Select and deselect tags by pressing **[YES]**. You can select multiple tags. Exit the tag list by pressing **[NO]**.

SEARCH will perform a text search and list all presets with names matching or including the text input. For more information, please see "6.5 THE NAMING SCREEN" on page 19 on how to enter text.



You can also press **[FUNC]** and then turn **LEVEL/DATA** to open the **LOAD (PRESET)** menu.

9.2.2 SAVE (PRESET)

Use this option to save the active tracks preset.

1. Use the **[UP]/[DOWN]** keys or **LEVEL/DATA** to select a slot to where you want to save the preset.
2. Press **[YES]** to save the preset to the selected slot. If the slot already contains a preset you are asked to confirm the save operation.
3. On the NAMING screen, name your preset and then press **[YES]**. For more information, please see "6.5 THE NAMING SCREEN" on page 19.
4. On the TAG screen you can add tags to the preset. The first two will show on the preset list. Press **[YES]** to apply or remove tags. Highlight <SAVE> and press **[YES]** to save.

ADD TO PRESET POOL adds the selected preset to the pool of the active project.

SELECT BANK opens the Preset bank selector. The currently selected bank is shown in parenthesis. Use the **[TRIG 8-16]** keys, the **[ARROW]** keys, or **LEVEL/DATA** to select bank.

SORT ABC / SORT 123 toggles between if the presets are sorted in alphabetical order or by slot number.

FILTER opens a list where presets can be arranged according to tags. Select and deselect tags by pressing **[YES]**. You can select multiple tags. Exit the tag list by pressing **[NO]**.

SEARCH will perform a text search and list all presets with names matching or including the text input. For more information, please see "6.5 THE NAMING SCREEN" on page 19 on how to enter text.

SHOW ALL SLOTS will, when ticked, show all the preset slots both populated and empty. When not ticked, it only shows empty slots.

9.2.3 MANAGE (PRESET)

Opens the Preset manager. Here presets can be saved, loaded, renamed, tagged et cetera. Opening this menu will show a list of all presets found in the +Drive library.

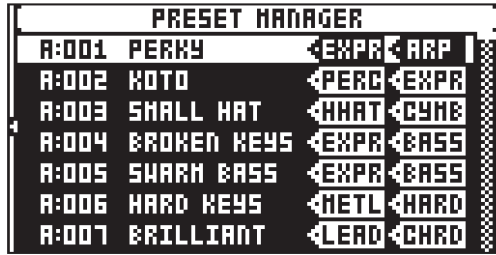

Press [LEFT] to access the SORTING menu. Press [YES] to execute the commands. Press [NO] or the [RIGHT] key to exit the menu.



ADD TO PRESET POOL adds the selected preset to the pool of the active project.

SELECT BANK opens the Preset bank selector. The currently selected bank is shown in parenthesis. Presets in the +Drive library are organized into eight banks, ranging from A to H. Each bank can contain 256 presets. Use the [TRIG 9-16] keys to view only presets located in a specific bank. Use the [TRIG 8-16] keys, the [LEFT]/[RIGHT] keys, or **LEVEL/DATA** to select bank.

SORT ABC / SORT 123 toggles between if the presets are sorted in alphabetical order or by slot number.

FILTER opens a list where presets can be arranged according to tags. Select and deselect tags by pressing [YES]. You can select multiple tags. Exit the tag list by pressing [NO].

SEARCH will perform a text search and list all presets with names matching or including the text input. For more information, please see "6.5 THE NAMING SCREEN" on page 19 on how to enter text.

SHOW ALL SLOTS will, when ticked, show all the preset slots both populated and empty. When not ticked, it only shows empty slots.

Press [RIGHT] to access the PRESET OPERATIONS menu. The available operations will affect the highlighted preset. Use **LEVEL/DATA** or the [UP]/[DOWN] arrow keys to navigate the menu. Press [YES] to apply the commands to the selected preset. Press [NO] or the [LEFT] arrow key to exit the menu.



LOAD TO TRACK loads the selected preset to the active track and makes it a part of the active pattern.

COPY TO BANK copies the selected presets to the first free slots of a specific bank inside the +Drive.

SAVE TO HERE saves the active track preset to the selected slot.

RENAME Opens a screen where you can rename the selected preset.

EDIT TAGS opens a menu where presets can be tagged. presets can have any number of tags, but only the first two will show on the preset list. Press [YES] to apply or remove tags. Highlight <SAVE> and press [YES] to save.

DELETE deletes the preset or selected presets.

SELECT ALL selects all presets in the list.

DESELECT ALL deselects all selected presets in the list.

TOGGLE enables or disables write protection for the selected presets. When a preset is write protected it cannot be overwritten, renamed, tagged or deleted. A write protected preset has a padlock symbol next to its name. The command is only available when you browse the +Drive library.

SEND SYSEX sends the selected presets as SysEx data.



- It is also possible to save/load/manage MIDI track presets in the same way as you do with audio track presets. They will automatically be tagged with the MIDI tag when they are saved. It is not possible to load a MIDI preset to the preset pool.
- You can preview the currently selected preset by pressing the [TRIG 1-16] key of the active track. Please note that if the previewed preset is sent to the effects, the current effects settings will affect it.
- Several presets can be simultaneously affected by the commands available in the PRESET OPERATIONS menu. Select/deselect individual presets by highlighting them and pressing [YES].
- Press [FUNC] + [UP]/[DOWN] for faster scrolling in the preset list.

9.2.4 POOL

Provides a quick access to the pool in the Preset manager. Here you can manage the preset pool. You can, among other things add presets, select multiple presets, delete presets, and rename presets. For more information about the preset pool, please see “9.1 THE +DRIVE LIBRARY AND THE POOL” on page 28.

Press [RIGHT] to access the PRESET OPERATIONS menu. The available operations will affect the highlighted preset. Use **LEVEL/DATA** or the [UP]/[DOWN] arrow keys to navigate the menu. Press [YES] to apply the commands to the selected preset. Press [NO] or the [LEFT] arrow key to exit the menu.

PRESET	LOAD TO TRACK
:::001 SWALL	SAVE TO HERE
:::002 SWARM	RENAME
:::003 BRILLI	DELETE
:::004 MONOLO	SELECT ALL
:::005 MATRIX	SELECT UNUSED
:::006 TUNED P	DESELECT ALL
:::007 MODULAR	

LOAD TO TRACK loads the selected preset to the active track and makes it a part of the active pattern.

SAVE TO HERE saves the active track preset to the selected slot.

RENAME Opens a screen where you can rename the selected preset.

DELETE deletes the preset or selected presets.

SELECT ALL selects all presets in the list.

SELECT UNUSED selects all presets that are not used in any pattern in the project.

DESELECT ALL deselects all selected presets in the list.

9.2.5 LOAD (KIT)

Use the [ARROW] keys or **LEVEL/DATA** to select a kit. Press [YES] to load the kit to the active pattern. Press the [TRIG] keys to preview the highlighted kit before you load it.

Press [LEFT] to access the SORTING menu. Use **LEVEL/DATA** or the [UP]/[DOWN] arrow keys to navigate the menu. Press [YES] to execute the commands. Press [NO] or the [RIGHT] arrow key to exit the menu.

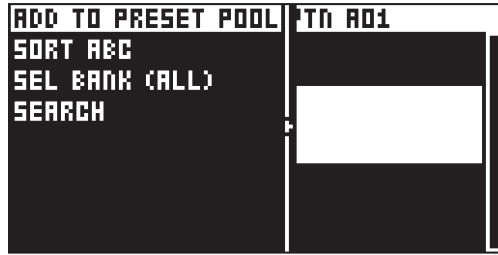

ADD TO PRESET POOL adds the kit's 16 presets to the pool of the active project.

SORT ABC / SORT 123 toggles between if the kits are sorted in alphabetical order or by slot number.

SELECT BANK opens the KIT bank selector. The currently selected bank is shown in parenthesis. Use the [TRIG 8-16] keys, the [ARROW] keys, or **LEVEL/DATA** to select bank.

SEARCH will perform a text search and list all kits with names matching or including the text input. For more information, please see "6.5 THE NAMING SCREEN" on page 19 on how to enter text.

9.2.6 SAVE (KIT)

Use this option to save the active patterns kit.

1. Use the [UP]/[DOWN] keys or **LEVEL/DATA** to select a slot to where you want to save the kit.
2. Press [YES] to save the kit to the selected slot. If the slot already contains a kit you are asked to confirm the save operation.
3. On the NAMING screen, name your kit and then press [YES] to save. For more information, please see "6.5 THE NAMING SCREEN" on page 19.

Press [LEFT] to access the SORTING menu. Press [YES] to execute the commands. Press [NO] or the [RIGHT] arrow key to exit the menu.

ADD TO POOL adds the kit's 16 presets to the pool of the active project.

SORT ABC / SORT 123 toggles between if the kits are sorted in alphabetical order or by slot number.

SELECT BANK opens the KIT bank selector. The currently selected bank is shown in parenthesis. Use the [TRIG 8-16] keys, the [ARROW] keys, or **LEVEL/DATA** to select bank.

SEARCH will perform a text search and list all kits with names matching or including the text input. For more information, please see "6.5 THE NAMING SCREEN" on page 19 on how to enter text.

SHOW ALL SLOTS will, when ticked, show all the kit slots both populated and empty. When not ticked, it only shows empty slots.

9.2.7 MANAGE (KIT)

Kits can be saved, loaded, renamed, tagged et cetera. Opening this menu will show a list of all presets found in the +Drive library.



Press [LEFT] to access the SORTING menu. Press [YES] to execute the commands. Press [NO] or the [RIGHT] key to exit the menu.



ADD TO POOL adds the kit's 16 presets to the pool of the active project.

SORT ABC / SORT 123 toggles between if the kits are sorted in alphabetical order or by slot number.

SELECT BANK opens the KIT bank selector. The currently selected bank is shown in parenthesis. Use the [TRIG 8–16] keys, the [ARROW] keys, or **LEVEL/DATA** to select bank.

SEARCH will perform a text search and list all kits with names matching or including the text input. For more information, please see “6.5 THE NAMING SCREEN” on page 19 on how to enter text.

Press [RIGHT] to access the KIT OPERATIONS menu. The available operations will affect the highlighted preset. Press [YES] to apply the commands to the selected kit. Press [NO] or [LEFT] arrow key to exit the menu.

HIT	LOAD TO PATTERN
A:001 NEW DDD	COPY TO BANK...
A:002 NEW DDD	SAVE TO HERE
A:003 TUFFIN	RENAME
A:004 ACQUST	DELETE
A:005 ELECTR	SELECT ALL
A:006 PUFF D	DESELECT ALL
A:007 TECHN	TOGGLE

LOAD TO PATTERN loads the selected kit to the active pattern.

COPY TO BANK copies the selected kits to BANK (A-H) The kit is copied to the first free slot of a specific bank inside the +Drive.

SAVE TO HERE saves the active kit to the selected slot.

LOAD TO EMPTY loads the selected kit to all empty patterns

RENAME opens a screen where you can rename the selected kit.

DELETE deletes the kit or selected kits.

SELECT ALL selects all kits in the list.

SELECT UNUSED selects all kits that are not used in any pattern in the project from the pool. The presets are not removed from the +Drive library. Then select DELETE to remove the selected kits from the project's pool.

DESELECT ALL deselects all kits in the list.

TOGGLE enables or disables write protection for the selected kits. When a kit is write protected it cannot be overwritten, renamed, tagged or deleted. A write protected kit has a padlock symbol next to its name. The command is only available when you browse the +Drive library.

SEND SYSEX sends the selected kit's presets as SysEx data.

9.3 PLAYING A PRESET

Press the [TRIG 1–16] keys to play the presets of the tracks in the active pattern. The [TRIG] keys will briefly light up when pressed.

9.3.1 PLAYING A PRESET WITH AN EXTERNAL MIDI UNIT

The presets can also be played using an external MIDI device connected to Digitone II. The MIDI channels for of each of the tracks can be assigned in the MIDI CHANNELS menu, covered in the section “13.4.3 CHANNELS” on page 74. You can also use an external MIDI unit to play a preset chromatically when you are in KEYBOARD mode. For more information, please see “8.5.1 KEYBOARD MODE” on page 24.

9.4 EDITING A PRESET

Select a track for editing by pressing [TRK] + one of the [TRIG 1–16] keys. When editing the settings of the track, any changes made will be stored as part of the active pattern.

Adjust the overall volume level of the active audio track with the **LEVEL/DATA** knob. This setting is saved as part of the kit.

Edit a preset by adjusting the parameters found on the PARAMETER pages. Access these pages by pressing a [PARAMETER] page key. Use the **DATA ENTRY** knobs A-H to change the parameters. For more information, please see “11. TRACK PARAMETERS” on page 55.

The complete preset, with all its parameter settings may be copied to another track. Press [TRK] + [TRIG 1-16] + [RECORD], and then press [TRK] + [TRIG 1-16] + [STOP] to paste the preset to the selected track.

9.5 SAVING A PRESET

After you edited the parameters of a preset, you can save it to the +Drive.

1. Press [PRESET/KIT] to open the PRESET/KIT menu.
2. Select PRESET > SAVE, and then press [YES].
3. Turn the *LEVEL/DATA* knob or use the [UP]/[DOWN] keys to select an empty slot to where you want to save your preset, and then press [YES].
4. On the NAMING screen, name your preset and then press [YES]. For more information, please see “6.5 THE NAMING SCREEN” on page 19.
5. On the TAGS screen, use the [ARROW] keys and [YES] key to select the appropriate tags for your preset, and then select <SAVE> and press [YES].

9.6 THE SETUP MENU

Press [FUNC] + [FLTR] to open the SETUP menu. Here you can set a number of track and kit related parameters. Use the [UP] and [DOWN] arrow keys to move between the options. Press [YES] to confirm your selection. Press [NO] to exit the menu.



9.6.1 KIT

Here you can select which tracks that should be affected by control all and set up the track routing to the compressor.

CONTROL ALL CONFIG

Use the [TRIG] keys to select which tracks that you want to be affected by the control all functionality. MIDI tracks can not be selected. For more information, please see “6.2.2 CONTROL ALL” on page 19.



- Control all operations also affects the active track, whether it is selected to be affected or not.
- The control all functionality is not available for the MIDI tracks.

COMPRESSOR ROUTING

Use the [TRIG] keys to select which tracks, inputs and effects that you want to be affected by the compressor. MIDI tracks can not be selected. Use the [UP]/[DOWN] to navigate between the two pages.

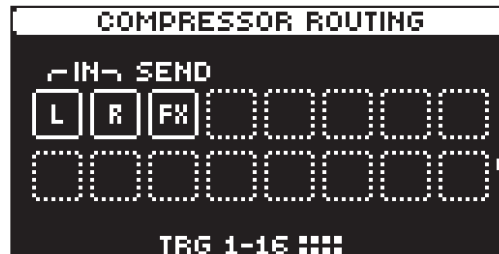

TRACK LAYERING

Track Layering makes it possible to trig two or more tracks with the same note from the sequencer or the keyboard. For example, if you set track 1 to trigger track 2 then every note you play on track 1 also plays on track 2, effectively playing two presets at the same time. However, the layering will not cascade trigs. If track 3 is set to be triggered by track 2, and track 2 is set to be triggered by track 1, trigs placed track 1 will not trigger track 3. Tracks that are layered to the active track have filled squares in the parameter representation on the screen.

Use [FUNC] + [TRK] to select the active track, then use the [TRIG] keys to select which tracks that will be layered to the active track.

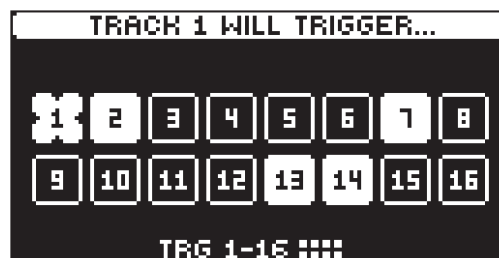

PATTERN TRANSPOSE

Use the [TRIG] keys to select/deselect which tracks that you want to be affected by pattern transpose.



9.6.2 TRACK

Here you can set a number of track related parameters. Use [UP] and [DOWN] to move between the options. Use [LEFT] and [RIGHT] to select settings or press [YES] to open sub-menus. Press [NO] to exit the menu.

PLAY MODE

Here you can set if a preset is poly- or monophonic and if the LFOs for every voice are synced or not.

POLY The Sound is polyphonic, and the LFOs for each voice are running independently of each other.

POLY M.LFO In POLYPHONIC WITH MONO LFO mode, the preset is polyphonic, and the LFOs for each voice are synced together with the first voice LFO. The LFO of the first voice played determines the cycle of the LFOs, and the subsequently played voices' LFOs are synced to this cycle. This makes the LFO behave like a single or monophonic LFO. This is useful, for example, if you want to use the LFO for a tremolo effect.

MONO The preset is monophonic, and the envelope is always triggered by each note on/key press.

MONO LEG. In MONO LEGATO mode, the preset is monophonic, but the envelopes are not triggered by a subsequent note on/key press if the first note is still held.



The number of voices used to play a preset is also affected by the **LOCKED VOICES** setting in the **VOICE MENU**. For more information, please see “10.7 VOICE SETUP MENU” on page 45.

MONO NOTE PRIO

Here you can set the note priority, i.e., what note is played if more than one note is played at the same time. This setting is only available if **PLAY MODE** is set to MONO or MONO LEG.

LAST gives priority to the last note played.

LOW gives priority to the lowest note played.

HIGH gives priority to the highest note played.

VELOCITY TO VOL

Selects how MIDI velocity affects volume when playing the preset from a MIDI keyboard.

OFF means velocity does not affect the volume of the sound.

LOG applies a logarithmic velocity curve. The volume difference are greater between softer keyboard presses than between harder.

LIN applies a linear velocity curve. The volume difference between keyboard presses corresponds linearly to the force applied.

EXP applies an exponential velocity curve. The volume difference are greater between harder keyboard presses than between softer.

EXP 2 applies an exponential velocity curve. The volume difference are greater between harder keyboard presses than between softer. The EXP 2 curve has a higher starting point, meaning that a low velocity has a higher impact on the volume than on EXP.

OCTAVE

Sets the base octave of the preset. It also makes preset locking more practical since you can control the octave setting on the preset and minimize the need to transpose the sequencer notes to make two or more presets work together.

PITCH BEND DEPTH

Sets how much the pitch bend data from external MIDI devices affects the Digitone II.

PORTAMENTO

Here you find settings related to the portamento. For more information, please see “11.3 TRIG PAGE 2” on page 56.

TYPE

TRACK When you play notes, the pitch glides from the pitch of the last note played to the next new note played on the track.

VOICE When you play notes, the pitch glides from the pitch of the last note played by a specific voice to the pitch of the next new note played by the same voice.

LEGATO ONLY When playing notes, the pitch glides from the pitch of the last note played and held (the key pressed down and not yet released) to the pitch of the next new note played on the track.

SLOPE

CONSTANT RATE The pitch glides linearly at a constant rate. Longer glides take longer time to complete.

CONSTANT TIME The pitch glides linearly, but the glide is completed in a specific time, regardless of the interval between the start and end notes. Glides over wider note intervals, therefore, have a higher rate.

AMOUNT

This setting enables partial glides where just the final part of the interval is included in the glide. For example, a setting of 100 gives a full glide from start to finish. Lower values start the glide closer to the goal pitch.

STYLE

GLIDE Ordinary continuous portamento.

GLISSANDO Quantizes the portamento to semitones.

GATING

OFF The glide continues after the key is released.

ON The glide stops when the key is released.

KEY TRACKING

Opens a menu where you can assign up to four parameters to the key tracking. Both the **NOTE** parameter on the TRIG menu and the key track information from incoming MIDI sent to the Digitone II from external devices affects the assigned parameters. Press **[YES]** to open the menu.

You can select parameters from the SYN, FLTR, AMP, FX, and MOD PARAMETER pages. Turn the **DATA ENTRY** knobs **A–D** to select the track parameters that you wish to assign. Press **[YES]** to confirm the selection. Then use **DATA ENTRY** knobs **E–H** to set the modulation depth of the four track parameters. The depth is an offset of the original track parameter value.

Turn **LEVEL/DATA** to test your settings.

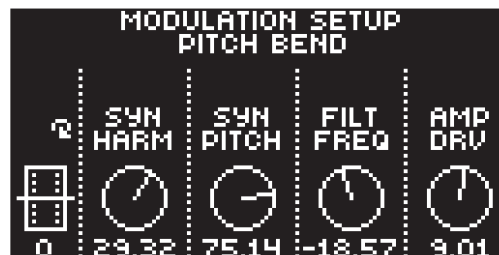

For key tracking, all modulation are centered around middle C (C5). A positive modulation value increases the parameter value when playing above C5 and decreases when you play a key below C5. A negative modulation value inverts this behavior.

For example: With a modulation value set to 8, each consecutive note changes the parameter value by 1. With a modulation value set to 127, each consecutive note changes the parameter value by 16, meaning that you reach the full parameter range in 8 notes

VELOCITY MOD

Opens a menu where you can assign up to four parameters to the velocity parameter. Both the **VEL** parameter on the TRIG menu and the velocity of incoming MIDI notes sent to the Digitone II from external devices affects the assigned parameters. Press **[YES]** to open the menu. Selecting parameters and setting modulation depth works in the same way as for **KEY TRACKING**.

AFTERTOUCH

Opens a menu where you can assign up to four parameters to the MIDI aftertouch command. Press **[YES]** to open the menu. Selecting parameters and setting modulation depth works in the same way as for **KEY TRACKING**.

PITCH BEND

Opens a menu where you can assign up to four parameters to the MIDI pitch bend command. Press **[YES]** to open the menu. Selecting parameters and setting modulation depth works in the same way as for **KEY TRACKING**.

MODULATION WHEEL

Opens a menu where you can assign up to four parameters to the MIDI mod wheel command (CC #1). Press **[YES]** to open the menu. Selecting parameters and setting modulation depth works in the same way as for **KEY TRACKING**.

BREATH CTRL

Opens a menu where you can assign up to four parameters to the MIDI breath controller command (CC #2). Press **[YES]** to open the menu. Selecting parameters and setting modulation depth works in the same way as for **KEY TRACKING**.

RENAME

Opens the NAMING menu and let you rename the preset of the active tracks.

9.7 ARPEGGIATOR MENU

The ARPEGGIATOR menu controls the preset's arpeggiator. These settings are part of the preset and saved together with the preset. The arpeggiator is not available for the MIDI tracks. Press **[ARPEGGIATOR]** to open the ARPEGGIATOR menu. Press **[TRIG 1-16]** to select the presets whose arpeggiator are edited. Press **[FUNC] + [ARPEGGIATOR]** to toggle the ARPEGGIATOR on and off.

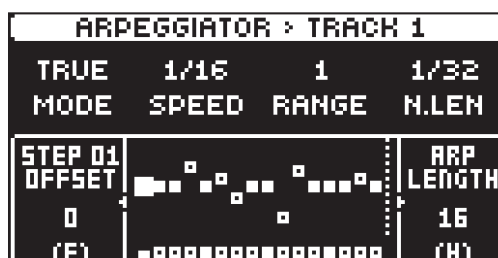
**9.7.1 MODE**

Activates the arpeggiator and controls how the arpeggiated notes are sorted.

OFF deactivates the arpeggiator.

TRUE plays the notes in the same order as they are inserted.

UP plays the notes in ascending order, from the lowest note to the highest, on a per octave basis.

DOWN plays the notes in descending order, from the highest note to the lowest, on a per octave basis.

CYCL plays the notes first in ascending order, then in descending order.

9.7.2 SPEED

Speed sets the speed of the arpeggiator. It is synchronized to the BPM of the project. (1/1-1/96).

9.7.3 RANGE

Range sets the octave range of the arpeggiator. After each completed arpeggiator cycle, the arpeggiated notes are transposed one octave up. When the notes have reached the octave offset specified by the RANGE setting the notes are reset to their initial values. From there the octave transpose is started all over again.

9.7.4 N.LEN

Note Length controls the length of the arpeggiated notes.

9.7.5 LEN

Turn **DATA ENTRY** knob **F** to select the length of the arpeggio. The max length is 16 sequencer steps.

9.7.6 OFS

Offset selects the offset (note) value of the chosen arpeggiator step in semi-tones. The offset is from the original note trig.

1. Press **[LEFT]** or **[RIGHT]** to select which arpeggiator step to offset.
2. Use **DATA ENTRY** knob **E** to set the offset.
3. Press **[DOWN]** to mute an arpeggiator step. Press **[UP]** to activate an arpeggiator step that has been deactivated.



Copy, Paste, Clear commands are available in the arpeggiator menu. For more information, please see "6.4 COPY, CLEAR, AND PASTE" on page 19.

10. THE SEQUENCER

The sequencer of the Digitone II stores information in patterns. A pattern controls the playback of the tracks and various pattern-specific aspects of the tracks. Patterns are stored in projects. A project contains 8 banks (A to H) with 16 patterns each, which means 128 patterns are available for each project. For more information, please see “13.3 PATTERN MENU” on page 71.

A pattern contains:

- General trig settings on the TRIG page (default note pitch, velocity et cetera).
- The kit with all parameter settings on the SYN, FLTR, AMP, FX and MOD pages.
- The settings on the DELAY, REVERB, CHORUS and MIXER pages.
- The settings in the SETUP menu.
- Quantization settings.
- Note trigs and Lock trigs for all tracks.
- Parameter/preset locks.
- Length and time signature for the tracks.

10.1 PATTERN OPERATIONS

Digitone II can seamlessly switch between patterns. This, together with the ability to chain patterns, is a handy feature when improvising live. For more information, please see “10.1.3 CHAINS” on page 39.

10.1.1 SELECTING BANK AND PATTERN

Press [PTN] and then use the [LEFT]/[RIGHT] keys to select a bank (if you want to select a pattern from another bank than the current). Then press [TRIG 1-16] to select a pattern.

There is a secondary way to change bank and pattern, more similar to earlier Elektron devices. Press [FUNC] + [PTN], and then press [TRIG 9-16] to select a bank. Then press [TRIG 1-16] to select a pattern within that bank.

If you just want to select a pattern within the current bank, press [PTN] + [TRIG 1-16].

Press [PTN] or [NO] to exit bank/pattern selection.

White [TRIG] keys indicate pattern positions that contain data. A red [TRIG] key indicates the current active pattern. Empty patterns are unlit.

When a pattern is playing, and a new pattern is selected, the new pattern number will be shown flashing in the upper left corner of the screen. Once the last step of the pattern has played, the new pattern will start, and the pattern number will cease to flash.



- Patterns can be changed while the sequencer is running.
- Patterns can be changed and queued by sending program change messages.
- It is possible to copy a pattern, and then paste it to one or several locations without leaving the active pattern. You can also clear one or several non-active patterns.
 - To copy, first press [PATTERN]. Then press [TRIG] + [RECORD] to select the pattern you wish to copy and copy it. Then press [TRIG] + [STOP] to select to where you want to paste the pattern and paste it.
 - To clear, first press [PATTERN]. Then press [TRIG] + [PLAY] to select the pattern you wish to clear and clear it.

10.1.2 PATTERN CONTROL

Press [PLAY] to start the playback of a pattern. Press [STOP] to stop the playback of all tracks. The sound will be cut off, but effects like Delay will continue to be audible until the delay repeats have faded out. Quickly press [STOP] + [STOP] to stop playback of all tracks and get just a short fade out of the send effects.

When a pattern is playing, press [PLAY] to pause the playback. Press [PLAY] to resume the playback.

If a pattern contains more than 16 sequencer steps, the <PATTERN PAGE> LEDs will indicate this. When a pattern is playing, the currently active pattern page is shown with a flashing, <PATTERN PAGE> LED.

10.1.3 CHAINS

Chains are sequences that consist of more than one pattern. You can use chains to preselect and automate the order in which you want your patterns to play



You can create one chain and it can contain any pattern in bank A–H. The chain can consist of up to 64 patterns.

1. Press **[PTN]**, and then press **[FUNC]** + **[YES]** to open the chain creator screen.
2. Use the **[LEFT]**/**[RIGHT]** keys to select a bank (if you want to select a pattern from another bank than the current). Then press **[TRIG 1-16]** to select a pattern. Repeat until you have created the desired chain.
3. (Optional) Press **[FUNC]** + **[LEFT]** to delete the last pattern from the chain.
4. Press **[YES]** to confirm the pattern chain and close the chain creator screen. Press **[NO]** if you wish to cancel the pattern chain and close the chain creator screen.
5. Press **[PLAY]** to start the sequencer and play the chain. The chain will be looped once the final pattern of the chain has played.

To exit chain mode, select a pattern or song using the normal selection process.

There is also a legacy procedure for creating chains.

1. Press and hold **[PTN]** and then press a **[TRIG 1-16]** key to select the first pattern in the chain.
2. Release the **[PTN]** key and then press **[TRIG 1-16]** keys in the same order as you want the chained patterns to play. Keep a previous **[TRIG]** key pressed while you press the next one, the one after that and so on. You can press the same **[TRIG]** key again if you wish to add the pattern multiple times in a row. If you want to add a pattern from another bank, use the **[LEFT]**/**[RIGHT]** keys to select a bank and then press **[TRIG 1-16]** to select pattern.
3. Press **[PLAY]** to start the sequencer and play the chain. The chain will be looped once the final pattern of the chain has played.



Please note that the chain will be lost when you create a new chain or when you select a new pattern/song. Chains cannot be saved and will be lost when you switch the Digitone II off.



- Chains can be created while the sequencer is running.
- You can also use MIDI program change messages from an external device to change patterns on the Digitone II. For more information, please see “13.4.1 SYNC” on page 72.

10.2 EDITING A PATTERN

Digitone II offers several modes of input when creating or editing a pattern. Three of them are, GRID RECORDING mode, LIVE RECORDING mode, and STEP RECORDING mode. In these modes, two types of trigs can be entered: Note trigs and Lock trigs.

10.2.1 TRIG TYPES

A trig is a sequencer event that you can place when you want the sequencer to perform an action on the Digitone II. There are two types of trigs that you can use, note trigs and lock trigs.

- **NOTE TRIGS** trigger preset notes or MIDI notes.
- **LOCK TRIGS** trigger parameter locks (but do not trigger notes). For more information, please see “10.12.1 PARAMETER LOCKS” on page 48.

Note trigs are indicated by red **[TRIG]** keys and lock trigs are indicated by yellow **[TRIG]** keys. Unlit **[TRIG]** keys indicate steps that does not contain any trigs. Read more about parameter locks in section “10.12.1 PARAMETER LOCKS” on page 48. Trigs are added differently in the sequencer, depending on whether GRID RECORDING, LIVE RECORDING, or STEP RECORDING mode is active. Note trigs can also be added in NOTE EDIT mode.

10.3 GRID RECORDING MODE

GRID RECORDING is a method of composing where you use the [TRIG] keys to add trigs.

1. Press [RECORD] to enter GRID RECORDING mode. The [RECORD] key lights up red to indicate that GRID RECORDING mode is active.
2. Select the track to which you want to add trigs by pressing and holding [TRACK] and then one of the [TRIG] keys. A red [TRIG] key indicates the active track.
3. Place note trigs on the sequencer using the sixteen [TRIG] keys. To add a lock trig, press [FUNC] + [TRIG]. Quickly pressing the [TRIG] key of any of the trigs entered will remove the trig. Pressing a [TRIG] key and holding it slightly longer will prepare the trig for editing, rather than removing it.
4. Select another track, and add note trigs. Repeat the procedure for all the tracks you want to use.
5. Press [PLAY] to listen to the sequence.

You can transpose a note trig by pressing and holding the [TRIG] key, and then press [+]/[-].

Add micro timing to a note trig by pressing and holding the [TRIG] key, and then press [LEFT]/[RIGHT]. For more information, please see “10.8 MICRO TIMING” on page 46.

Set the retrig speed by pressing and holding the [TRIG] key while navigating to TRIG PAGE 2 keys and make the desired settings. For more information, please see “10.9 RETRIGS” on page 46, and “11.3 TRIG PAGE 2” on page 56.

If the pattern contains more than 16 steps, select the pattern page you want to edit by pressing the [PAGE] key. A fully lit <PATTERN PAGE> LED shows the active pattern page.

Press [RECORD] to exit the GRID RECORDING mode.



- If your pattern has more than one page you can easily select which page you want to edit. Press and hold [PAGE], and then press one of the [TRIG 1–8] keys that light up to select the active page for editing. You can also cycle through the pages with the [LEFT] and [RIGHT] keys while holding [PAGE]. For more information, please see “10.11 PAGE SETUP MENU” on page 46.
- You also have the possibility to select which pages of your pattern you want the sequencer to play and loop. The selected pages are then looped on playback. In GRID RECORDING mode, press and hold [PAGE], and then press [TRIG 9–16] to select which pattern pages you want to play and loop. Green [TRIG] keys shows the selected pages. The [TRIG 9–16] keys corresponds to pattern page 1–8. For example, you have an eight page pattern and you want to play and loop page 1, 2, 5, and 7. To accomplish this, press and hold [PAGE] and then press [TRIG 9, 10, 13, 15]. On the top row, [TRIG 1–8], the blinking [TRIG] key shows the master playback position. On the bottom row, [TRIG 9–16], the blinking [TRIG] key shows the page currently playing. Press and hold [PAGE] and then press [NO] to resume normal playback of all pages in the pattern.
- You can use an external MIDI controller such as a keyboard to input NOTE and TRIG VELOCITY data when you are in GRID RECORDING mode. Just press and hold a [TRIG] key, and then play a note on the external keyboard. The first note sets the TRIG VELOCITY value for all notes on the trig.
- Press [TRIG] + [YES] to preview a specific trig. The preview includes any parameter locks you have placed on that trig.
- Press [TRIG] + [PRESET/KIT] to save the sound of a trig as a preset, taking all parameter locks into consideration.
- If you use an external MIDI controller to record to the Digitone II MIDI tracks, the sequencer receives data on the Auto MIDI channel and records on the active track. For more information, please see “13.4.3 CHANNELS” on page 74.
- All trigs of a track can be shifted forwards or backward on the sequencer. While in GRID RECORDING mode, hold down [FUNC] while pressing the [LEFT] or [RIGHT] arrow keys to perform the trig shift.

10.3.1 NOTE EDIT MENU

The NOTE EDIT menu is part of the GRID RECORDING mode and gives you the possibility to separately edit each note of a step, even if they are part of a polyphonic chord. You can edit four different parameters. NOTE, LEN, and VEL are the same parameters that can be found on the TRIG PAGE 1. For more information, please see “11.2 TRIG PAGE 1” on page 55. The fourth parameter, TIME lets you adjust the timing of each note. You can also use the NOTE EDIT menu to add new notes.

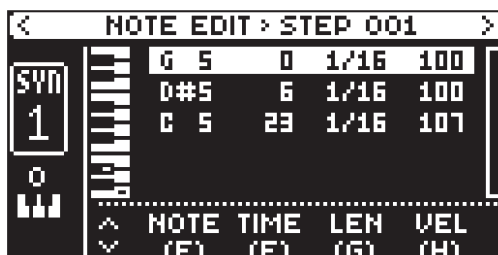

EDITING NOTES ON ALREADY PLACED TRIGS

In GRID RECORDING mode, press the placed [TRIG] + [NOTE EDIT] to open the NOTE EDIT menu. Use [UP]/[DOWN] to highlight the note you want to edit. Then use *DATA ENTRY* knobs *E-H* to change the parameters. Hold [FUNC] and then turn *DATA ENTRY* knobs *E-H* to change the parameters to affect all notes on that step.

NOTE Sets the note value for the selected note. The selectable notes are limited to the ones existing in the scale selected in the KEYBOARD SETUP menu if **NOTE PARAM** is set to SCALE in the PERSONALIZE menu. For more information, please see “8.5.2 KEYBOARD SETUP MENU” on page 24. Press and turn *DATA ENTRY* knob *A* to select any note in the Chromatic scale.

TIME Sets the micro timing for the selected note. A positive value moves the note later. A negative value moves the note earlier. For example, a value of 12 moves the note halfway towards the next trig. A value of -6 moves the note a quarter of the way towards the previous trig. The full range is -23–23.

LEN Sets the note length for the selected note.

VEL Sets the velocity for the selected note.

Use the following shortcuts for further editing.

- [FUNC] + [LEFT]/[RIGHT] to go to the previous/next sequencer step that contains a note trig.
- [LEFT]/[RIGHT] to go the previous/next sequencer step regardless if it contains a trig or not.
- [FUNC] + [UP] to delete the highlighted note.
- [FUNC] + [DOWN] to add a note below the highlighted note.
- [FUNC] + [YES] to preview the selected step. The preview only takes the **NOTE** and **VEL** settings into account. The **TIME** and **LEN** settings can not be previewed.

ADDING AND EDITING NOTES USING NOTE EDIT

Press [NOTE EDIT]. GRID RECORDING mode is switched on and by default, The [TRIG] keys are set to work like in KEYBOARD mode. You can also select which step to edit manually by pressing [FUNC] + [TRIG] key. Press [FUNC] + [PAGE] to navigate to the next pattern page.



You can also use an external MIDI keyboard to add notes in the NOTE EDIT menu.

1. Connect an external MIDI controller to the Digitone II.
2. Set the controllers MIDI channel to the same channel as Digitone II's AUTO CHANNEL
3. Press [NOTE], and then select the active step that you wish to record on..
4. Press [REC], and then press the keys on the MIDI controller

The note values, the length, and the velocity are then recorded on the active step.

10.4 LIVE RECORDING MODE

LIVE RECORDING mode is the second method of adding trigs to the tracks. In this recording mode, the [TRIG] keys are played in real time to input trigs to the tracks. You can also use KEYBOARD mode to add note trigs chromatically. Additionally you can add velocity, retrigs, and change presets using the TRIG modes. It is also possible to enter parameter locks in real time. Trigs input in LIVE RECORDING mode can be automatically quantized or not. Non-quantized trigs can be quantized after they are recorded, by using the QUANTIZE menu that is accessed by pressing [FUNC] + [TRIG]. For more information, please see “10.10 QUANTIZE MENU” on page 46.

1. Press and hold [RECORD], then press [PLAY] to enter LIVE RECORDING mode. (Press [PLAY] twice while keeping the [RECORD] key pressed to activate/deactivate automatic quantization.) The sequencer starts to play, and the [RECORD] key starts to flash red.

2. Enter trigs in real time by pressing the **[TRIG]** keys. If **KEYBOARD** mode is active, the pitch value of the note trig will be recorded according to which **[TRIG]** key is pressed for the active track. Any changes to **PARAMETER** page settings, using the **DATA ENTRY** knobs, will be recorded as parameter locks and add lock trigs where needed.
3. Press **[PLAY]** to exit **LIVE RECORDING** mode while keeping the sequencer playing. If **LIVE RECORDING** mode is active and **[RECORD]** is pressed, **GRID RECORDING** mode will be activated.
4. Press **[STOP]** to stop both recording and playback of the sequencer.



You can use an external MIDI controller such as a keyboard to input **NOTE**, **TRIG VELOCITY**, and **TRIG LENGTH** data in **LIVE RECORDING** mode. Just play the notes on the external keyboard and they will be recorded by the sequencer. The first note sets the **TRIG VELOCITY** value for all notes on the trig. The last note that is released sets the **TRIG LENGTH** for all notes on the trig.

10.5 STEP RECORDING MODE

STEP RECORDING is a quick and straightforward method of placing trigs on the sequencer. In this recording mode, you insert notes by pressing the **[TRIG]** keys or by using an external MIDI controller. The sequencer then captures the note and automatically advances to the next step. There are two different modes available, **STANDARD** mode and **JUMP** mode.

STANDARD mode

1. Press **[RECORD]** + **[STOP]** to enter **STEP RECORDING** mode. The **[RECORD]** key starts to double-blink red. (Press **[STOP]** twice while keeping the **[RECORD]** key pressed to toggle between **STANDARD** and **JUMP** mode).
2. Press a **[TRIG]** key to select the active step to where you want to start to add note trigs. The active step is shown with a green **[TRIG]** key that double-blinks. (If positioned on an earlier placed trig, it inherits the light pattern of that trig). You can also use **[LEFT]/[RIGHT]** to select the active step or skip steps.
3. Press and hold **[FUNC]** and then press **[TRIG 1-16]** key to add a note trig on the corresponding track to the active step. The active step then automatically advances to the next step. You also have the option to add note trigs chromatically on the selected active track.
4. Press **[TRK]** + **[TRIG 1-16]** to select the track to which you want to add trigs. A red **[TRIG]** key indicates the active track.
5. Press and hold **[KEYBOARD]** and then press any lit **[TRIG]** key to add a note trig with the corresponding note value to the selected step. The active step then automatically advances to the next step. You can use **[+]/[-]** or **[UP]/[DOWN]** to transpose the chromatic keyboard on the **[TRIG]** keys up or down in octaves.
6. To remove a trig or to add a rest (no trig), position the active step on the trig that you want to remove or add a rest to, and then press **[NO]**. The active step then automatically advances to the next step.
7. To add a parameter lock to a trig, press and hold a **[TRIG]** key, and then turn the **DATA ENTRY** knob that controls the parameter you want to lock and set it to the desired value. The graphics become inverted for the locked parameter, and the locked parameter value is displayed. The **[TRIG]** key of the locked trig blinks red (for note trigs) or yellow (for lock trigs) to indicate that the trig now contains a parameter lock.
8. Press **[RECORD]** to exit **STEP RECORDING** mode.

JUMP mode

In **JUMP** mode, the **LEN** parameter setting on the **TRIG PARAMETER** page controls the note length of the trigs you place, and advances the active step the same length. A **LEN** value of 1/16 adds a sixteenth note and advances the sequencer one step. 1/8 adds an eighth note and advances the sequencer two steps. 1/4 adds a quarter note and advances the sequencer four steps and so on. The **LEN** parameter is also parameter locked on every trig you place.



- Press [PLAY] to listen to the sequence while you are programming it. Press [STOP] to stop the sequencer and stay in STEP RECORDING mode.
- If you use an external MIDI controller, you must set it to send MIDI data on the Digitone II's defined AUTO CHANNEL. For more information, please see "13.4.3 CHANNELS" on page 74.
- If you use an external MIDI controller, the trig's VEL (velocity) value is determined by the velocity sent from these and is parameter locked.
- If you press and hold [FUNC] while inputting notes from an external MIDI controller, the velocity is fixed and determined by the VEL parameter setting.
- If you press and hold [YES] while you place a trig with [TRIG] keys or an external MIDI controller, the trig length is locked to the time you press the [TRIG] keys or the external MIDI controller.
- If you add a new note trig on a previously placed note trig, any parameter locks previously placed on that trig remain as they were.
- In STEP RECORDING mode, to avoid accidental key presses, [FUNC] + [NO] does not reload the pattern. [FUNC] + [YES] does not save the pattern. Instead they work as described above.

10.6 SEQUENCER MENU (EUCLIDEAN MODE)

The Euclidean sequencer mode uses two separate pulse generators to generate events (trigs) that are placed as evenly spread out over the sequencer track's trigs as possible. You can also set a Boolean logic operator to combine or subtract the trigs from the two pulse generators in different ways.

When you turn on Euclidean mode for a track, the [REC] button will turn blue indicating the mode is active, and the [TRIG] keys where the generated trigs are placed will also be blue. Any trigs placed on the sequencer before activating the Euclidean mode will be hidden and inactive while in this mode, but they'll reappear when you turn the mode off again. If you want to convert an Euclidean sequence into regular sequencer trigs, just press and hold [FUNC] while turning the Euclidean mode off. This will remove any trigs that were placed prior to entering Euclidean mode. While in Euclidean mode, it is not possible to add note trigs manually to the sequencer. However, you can still do parameter locking on the already generated trigs.

Press [FUNC] + [AMP] open the SEQUENCER menu.



PL1 Pulse generator 1 sets the number of pulses (trigs) placed on the sequencer by this generator.

PL2 Pulse generator 2 sets the number of pulses (trigs) placed on the sequencer by this generator.

LEN Track length sets how many steps the track will have. This parameter is only available in PER TRACK mode. For more information, please see "10.11 PAGE SETUP MENU" on page 46.

EUC Euclidean mode switches the Euclidean sequencer mode on/off.

R01 Rotation generator 1 rotates the trigs placed by generator 1 forward or backwards on the track.

R02 Rotation generator 2 rotates the trigs placed by generator 2 forward or backwards on the track.

TRO Track rotation rotates the trigs placed by both generator 1 and generator 2 forward or backwards on the track.

OP Boolean operator lets you add or subtract the trigs generated from the two pulse generators in different ways based on mathematical logical expressions.

OR All trigs from both generator 1 or 2 are placed on the track.

XOR Trigs from both generator 1 or 2 are placed on the track unless they are added to the same sequencer step.

AND Only trigs added to the same sequencer step by generator 1 and 2 are placed on the track.

SUB Trigs from generator 1 are placed on the track unless generator 2 adds a trig on the same step as generator 1.



In Euclidean mode, please note that if you press any already generated trigs, they will remain in regular sequencer mode when you switch Euclidean mode off.

10.7 VOICE SETUP MENU

Press [VOICE SETUP] to open the VOICE SETUP menu, where you handle the allocation of the Digitone II's 16 voices. In this menu, you can also make the settings for unison and voice stealing. Press [TRK] + [TRIG 1-16] to select which track to edit. At the top of the screen, you can see what track is selected. The center of the screen shows the currently playing voices. Use the **DATA ENTRY** knobs to change the settings. Press [NO] to exit the menu. The voice settings are stored in the active pattern.

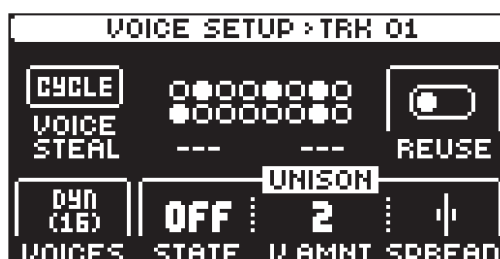

VOICE STEAL The Digitone II has 16 voice polyphony. **VOICE STEAL** sets the rules for how voices are stolen (which voice is taken when you play a new note) when you use more than 16 voices at the same time. The **VOICE STEAL** parameter affects the whole pattern.

CYCLE The first played note is stolen first.

TRACK Track priority. Notes played on track 1 has priority over notes played on track 2-16. Track 2 notes over track 3-16. Track 3 notes over track 4-16 etc.

LO Lowest note is stolen first

HI Highest note is stolen first.

REUSE Sets if the same note played twice should reuse the same voice, or cycle to use another free voice.

ON Reuses the same voice. Useful for staccato effects and drums.

OFF Cycles to use another voice. Good for piano-like sounds and pads.

VOICES Sets the number of voices (1-16) you want to lock to a specific track. A locked voice cannot be used or stolen by another track. If you lock voices to a track, the track cannot use more voices than the ones that are locked to it. The first number shows the number of locked voices to the track. The number in brackets shows how many unlocked voices that remain. If you set the parameter to DYN (dynamic) it will use any available voices to play its preset.



The number of voices that are used to play a preset is also affected by the **PLAY MODE** setting in the **SETUP** menu. For more information, please see "9.6 THE SETUP MENU" on page 34.

STATE Unison State turn unison on/off. Unison gives the possibility to add several voices to play the same note.

V.AMNT Unison Voice Amount sets the number of voices that plays for each note.



[FUNC] + [VOICE SETUP] toggles unison on/off.

SPREAD Unison Spread adds pan and detune to the unison voices.



You can copy the settings in the **VOICE** menu and paste it to another pattern. In the **VOICE** menu, press [FUNC] + [RECORD] to copy the parameter settings. Change pattern and open **VOICE** menu, and then press [FUNC] + [STOP] to paste the settings.

10.8 MICRO TIMING

Here you can add micro timing to a note trig, moving it ahead or behind the beat. Micro timing can be customized on any of the sequencer steps on both audio and MIDI tracks. In GRID RECORDING mode, press and hold one or several [TRIG] keys and then press [LEFT]/[RIGHT] to access the pop-up Micro timing menu that shows the time offset for the chosen sequencer step(s) on the active track. Press [LEFT]/[RIGHT] to adjust the time offset. To exit the MICRO TIMING menu, release the [TRIG] key(s). The micro timing settings are stored in the active pattern.



10.9 RETRIGS

Retrigs can be customized on any of the sequencer steps on the audio tracks (the retrigger function is not available on the MIDI tracks). In GRID RECORDING mode, press [TRIG PARAMETERS] twice to access the RETRIG PARAMETERS page. Hold one or several [TRIG] keys and then set the desired retrigger options for the trig(s).

For more information about the parameters on this page, please see “11.3 TRIG PAGE 2” on page 56.

10.10 QUANTIZE MENU

The quantization affects all micro timed and off grid trigs on the sequencers tracks. Press [FUNC] + [TRIG PARAMETERS] to access this menu. Change settings with *DATA ENTRY* knob *E* and *H*.

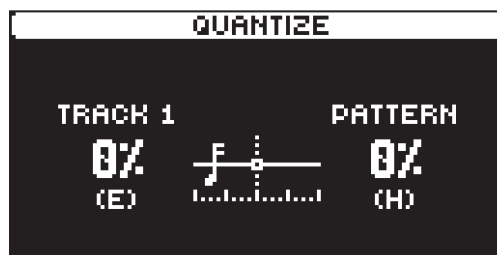

TRACK affects all the trigs of the active track in real time. The higher the quantize value, the more the trigs will be quantized. Press [TRIG 1-16] key to select track to quantize.

PATTERN affects all the trigs of all tracks in the pattern in real time. The higher the quantize value, the more the trigs will be quantized.

Press [NO] to exit the menu.

10.11 PAGE SETUP MENU

You can set the length and timing of the pattern and the tracks in this menu. The sequencer has up to 128 steps spread over 8 pages with 16 steps each. The PAGE SETUP menu has two modes. In PER PATTERN mode all tracks share the same length. In PER TRACK mode, each track can have different lengths. Press [FUNC] + [PAGE] to access the PAGE SETUP menu. Press [FUNC] + [YES] to toggle between the two modes. Use the *DATA ENTRY* knobs to adjust the settings.

10.11.1 PER PATTERN MODE

In this mode, all tracks of the pattern share the same length and time signature.

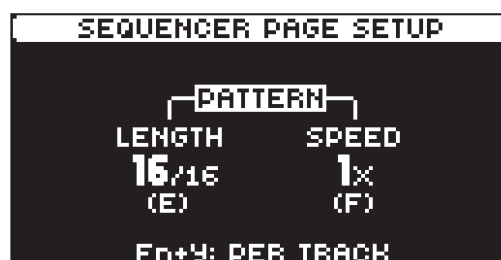

LENGTH sets the amount of steps on the current pattern page. The leftmost number displays the number of steps selected. If you use 17 steps or more in a pattern, the **[PAGE]** key is (while in GRID RECORDING mode) used to toggle between the different pattern pages.

SPEED controls the speed of pattern playback in multiples of the current tempo. It offers seven possible settings, 1/8X, 1/4X, 1/2X, 3/4X, 1X, 3/2X and 2X. A setting of 1/8X plays back the pattern at one-eighth of the set tempo. 3/4X plays the pattern back at three-quarters of the tempo; 3/2X plays back the pattern twice as fast as the 3/4X setting. 2X makes the pattern play at twice the BPM.

When you extend the length of a pattern, it trigs copies automatically over to the new steps. (If this option is selected in SETTINGS > PERSONALIZE > AUTO COPY) If a pattern consists of for example two pages and the pattern length is increased to four pages, the two additional pattern pages are then copies of the first two pattern pages.

Press the **[PAGE]** key repeatedly to change the total length of the pattern quickly. Press the **[TRIG]** keys to change the number of steps of the pattern quickly.



A 2X speed setting is useful for increasing the base resolution of the step sequencer to 32nd notes. A 3/4X setting is useful when Digitone II is playing alongside other instruments set to the same BPM, and you want Digitone II to play triplets.

10.11.2 PER TRACK MODE

In this mode, you can assign individual length and speed to the tracks of the pattern. Press **[FUNC] + [YES]** to switch between the two modes. In PER TRACK mode, you find two sections, TRACK and PATTERN.

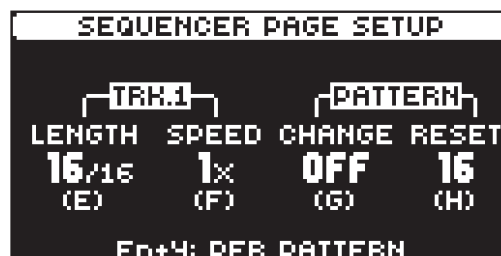

The TRACK column sets the step length and speed of the track. The settings only affects the active track.

The PATTERN column sets the master change length and the master length of the pattern.

LENGTH sets the amount of steps on the current pattern page. The leftmost number displays the number of steps on the active pattern page. If you use 17 steps or more in a pattern, the **[PAGE]** key is (while in GRID RECORDING mode) used to toggle between the different pattern pages.

SPEED controls the speed of track playback in multiples of the current tempo. It offers seven possible settings, 1/8X, 1/4X, 1/2X, 3/4X, 1X, 3/2X and 2X. A setting of 1/8X plays back the track at one-eighth of the set tempo. 3/4X plays the track back at three-quarters of the tempo; 3/2X plays back the track twice as fast as the 3/4X setting. 2X makes the track play at twice the BPM.

CHANGE (Pattern Change) controls for how long the active pattern plays before it changes to a cued or chained pattern. This setting is important when, for example, you set **RESET** to INF. Then, if you do not make any **CHANGE** setting, the pattern plays infinitely and the next cued pattern will never play. By default a cued pattern change happens at the end of the pattern (**CHANGE** set to OFF).

RESET (Pattern Reset) controls the number of steps the pattern plays before all tracks resets and restarts from the first step on the first page. An INF setting makes the tracks of the pattern loop infinitely, without ever being restarted. Note that this setting also affects for how long the active pattern plays before a chained pattern starts playing. The **CHANGE** parameter overrides this if its parameter value is less than the **RESET** value.



In the **PAGE SETUP** menu, you can press **[FUNC] + [UP]/[DOWN]** to set the **TRACK LENGTH** in increments from 2/16 to 128/128.

10.12 SEQUENCER FEATURES

10.12.1 PARAMETER LOCKS

Parameter locks makes it possible to set every trig to have its own unique parameter values. The note trigs of an audio track can, for example, have different pitch, amp or filter settings. It is possible to parameter lock the parameters found on the **PARAMETER** pages, and you can apply parameter locks to all types of tracks. For a complete overview of all parameters on the **PARAMETER** pages, please see “11. TRACK PARAMETERS” on page 55, and “APPENDIX A: MACHINES” on page 87.

Adding parameter locks in **GRID RECORDING** mode.

1. Press **[RECORD]** to enter **GRID RECORDING** mode.
2. Press a **[TRIG]** key to add a Note trig or **[FUNC] + [TRIG]** key to add a Lock trig where you want to perform a parameter lock.
3. Press and hold the **[TRIG]** key of a previously placed trig (note trig or a lock trig).
4. Turn the **DATA ENTRY** knobs that control the parameter you want to lock, and set it to the desired value. The graphics become inverted for the locked parameter, and the locked parameter value is displayed. The **[TRIG]** key of the locked trig blinks red (for note trigs) or yellow (for lock trigs) to indicate the trig now contains a parameter lock.

Remove a single parameter lock by holding **[TRIG]** + pressing the **DATA ENTRY** knob of the locked parameter. You can erase all parameter locks from a trig if you remove the note trig and then enter it again.

Adding parameter locks in **LIVE RECORDING** mode.

1. Press and hold **[RECORD]**, then press **[PLAY]** to enter **LIVE RECORDING** mode.
2. Turn a **DATA ENTRY** knob, or play the **[TRIG]** keys in **KEYBOARD** mode, to add parameter locks to the active track. Note trigs are placed, and parameter locked accordingly, and it also places lock trigs that contains the parameter locks on the sequencer steps that do not already have any trigs.

Press **[NO]** + one (or several) of the **[TRIG]** keys to erase a sequence of recorded trigs on a specific track (or on several tracks) in time with the sequencer, i.e. all held trigs reached by the pattern's play-head will be erased.

You can also remove specific parameter locks on a track in real time. In **LIVE RECORDING** mode, press and hold **[NO]** and then press and hold the **DATA ENTRY** knob corresponding to the parameter that you want to remove.

Adding parameter locks in **STEP RECORDING** mode.

1. Press and hold **[RECORD]**, then press **[STOP]** to enter **STEP RECORDING** mode.
2. Press and hold a **[TRIG]** key, and then turn the **DATA ENTRY** knobs that control the parameter you want to lock, and set it to the desired value. The graphics become inverted for the locked parameter, and the locked parameter value is displayed. The **[TRIG]** key of a locked trig blinks red (for note trigs) or yellow (for lock trigs) to indicate that the trig contains a parameter lock.



- Up to 80 different parameters can be locked in a pattern. A parameter counts as one (1) locked parameter no matter how many trigs that lock it. If for example the cutoff parameter of the filter is locked on every sequencer step, there are still 79 other parameters that can be locked.
- In **GRID RECORDING** mode, if you press and hold a trig that contains parameter locks, the **[PARAMETER]** page keys lights up in red to show the location of the locked parameters.

10.12.2 PRESET LOCKS

You can change a track's preset to another preset from the pool on any individual sequencer step. These preset locks are an immensely useful feature for adding variations to a track. Press and hold a note trig and turn the **LEVEL/DATA** knob to open the pool list. Use the **LEVEL/DATA** knob to scroll through the list. Select the preset you want to assign to the note trig and then release the **[TRIG]** key. Press and hold the **[TRIG]** key of the note trig to show the assigned preset. For more information, please see “9.1.1 ADDING PRESETS TO THE POOL” on page 28, and “9.2.1 LOAD (PRESET)” on page 29.

10.12.3 TRIG CONDITIONS AND CONDITIONAL LOCKS

Trig conditions are a set of conditional rules that you can apply to any trig, using specific parameter locks called conditional locks. Each rule is a logical condition that determines whether a trig set on a track in the sequencer is triggered or not. If the condition is true, then the trig will play. If the condition is false, the trig will not play.

ADDING A CONDITIONAL LOCK

1. In GRID RECORDING or STEP RECORDING mode, place a note trig or lock trig on the sequencer step to where you want to apply a conditional lock.
2. Press and hold the trig to access the **COND** (Trig Condition) parameter on the TRIG PAGE 1. For more information, please see “11.2 TRIG PAGE 1” on page 55.
3. Turn **DATA ENTRY** knob **H** to select one of the following trig conditions:

PRE is true and the trig plays if the most recently evaluated trig condition on the same track was true. (**PRE** and $\overline{\text{PRE}}$ conditions are not evaluated and are ignored.)

$\overline{\text{PRE}}$ (Not PRE) is true when PRE is false. A trig with this trig condition plays if the most recently evaluated trig condition on the same track was not true. (**PRE** and $\overline{\text{PRE}}$ conditions are ignored and not evaluated.)

Example 1: Trig 1, 50% = True > Trig 2, $\overline{\text{PRE}}$ = False > Trig 3, $\overline{\text{PRE}}$ = False > Trig 4, PRE = True

Example 2: Trig 1, 50% = False > Trig 2, $\overline{\text{PRE}}$ = True > Trig 3, $\overline{\text{PRE}}$ = True > Trig 4, PRE = False

NEI is true and the trig plays if the most recently evaluated trig condition on the neighbor track was true. (**PRE** and $\overline{\text{PRE}}$ conditions on the neighbor track are not evaluated and are ignored) The neighbor track is the track before the active track. For example, track 3 is the neighbor track of track 4. **NEI** and $\overline{\text{NEI}}$ conditional trigs on track 4 therefore evaluate the conditional trigs placed on track 3. The **NEI** condition is false if no conditional trigs exist on the neighbor track.

$\overline{\text{NEI}}$ (Not NEI) is true when NEI is false. A trig with this trig condition plays if the most recently evaluated trig condition on the neighbor track was not true. (**PRE** and $\overline{\text{PRE}}$ conditions on the neighbor track are ignored and not evaluated.)

1ST The trig plays only on the first loop of the pattern.

$\overline{\text{1ST}}$ (Not 1ST) The trig does not play on the first loop of the pattern.

LST The trig plays the last time the pattern plays before changing to another pattern.

$\overline{\text{LST}}$ (Not LST) The trig does not play the last time the pattern plays before changing to another pattern.

A:B **A** sets how many times the pattern (or track, if the track length is shorter than the pattern length) plays before the trig condition is true. **B** sets how many times the pattern (or track, if the track length is shorter than the pattern length) plays before the count is reset and starts over again. This cycle then repeats until you stop the sequencer.

For example:

With the setting 1:2, the trig plays the first time the pattern plays and then the third, the fifth, and so on. With the setting 2:2, the trig plays the second time the pattern plays and then the fourth, the sixth, and so on.

With the setting 2:4, the trig plays the second time the pattern plays and then the sixth, the tenth, and so on.

With the setting 4:7 the trig plays the fourth time the pattern plays and then the eleventh, the eighteenth, and so on.

$\overline{\text{A:B}}$ (Not A:B) is true when A:B is false. Meaning a trig with this condition plays when the set condition of pattern plays are not met.

For example:

With the setting $\overline{2:4}$, the trig does not play the second time the pattern plays and then not on the sixth, the tenth, and so on.



Conditional parameter locks are a great way to add variety to a pattern. To set up a grid of mutually exclusive or conclusive note trigs across any of the tracks, and adding some probability locks in there as well (perhaps, in turn, also sporting an array of logically conditioned trigs), is a neat way to make the most minimal of compositions come alive with randomness.



- The FILL trig condition has a separate parameter on TRIG PAGE 1. For more information, please see “11.2 TRIG PAGE 1” on page 55.
- The sequencer needs to be in FILL mode to activate the conditional lock called FILL. For more information, please see “10.12.4 FILL MODE” on page 50.
- FILL trig conditions may also be used, for example, to have two different melodic or percussive sequences on the same track, one of which is activated only when FILL mode is active.

10.12.4 FILL MODE

FILL mode can be used to create a temporary variation, such as a drum fill, in your pattern.

Press **[YES]** + **[PAGE]** to activate FILL mode for one pattern cycle. It will become active when the pattern loops, and remain active until it loops again. You can also activate FILL mode at any time, and for any duration, by pressing and holding the **[PAGE]** key when the pattern is playing (when not in GRID RECORDING mode). The FILL mode is active for as long as the key is held.

Press and hold **[PAGE]** + **[YES]**, and then release **[PAGE]** before you release **[YES]** to latch FILL mode. Press **[PAGE]** again to unlatch FILL mode.

10.12.5 COPY, PASTE AND CLEAR OPERATIONS

Patterns, tracks, track pages, parameter pages, and trigs can be copied, pasted and cleared.

The active pattern can be copied to another location in the same bank or in another bank. To perform a pattern copy operation, GRID RECORDING mode must be deactivated. Copy the pattern by pressing **[FUNC]** + **[RECORD]**. Select another pattern, and then press **[FUNC]** + **[STOP]** to paste the copied pattern to this location. Press **[FUNC]** + **[PLAY]** to clear all the trigs in the current pattern.

Individual sequencer tracks can be copied, pasted and cleared in the same way as patterns. To do so, GRID RECORDING mode must be active.

A single track page may also be copied, pasted and cleared. It is similar to copying/pasting/clearing a track, but will only affect the active track page. Select the track page of choice by pressing the **[PAGE]** key. Copy by pressing **[PAGE]** + **[RECORD]**. Select a new track page and press **[PAGE]** + **[STOP]** to paste. Press **[PAGE]** + **[PLAY]** to clear the active track page.

A single parameter page with all its settings may also be copied, pasted and cleared. Select the parameter page you wish to copy by pressing a **[PARAMETER]** key. Copy by pressing **[PARAMETER]** + **[RECORD]**. Select a new track and then press the same **[PARAMETER]** page + **[STOP]** to paste. Press **[PARAMETER]** + **[PLAY]** to clear the parameter page.

Trigs, complete with all parameter lock settings, can be copied, pasted and cleared as well. GRID RECORDING mode needs to be active to access this functionality. Press and hold a trig and press **[RECORD]** to perform the copy operation. Paste by holding another **[TRIG]** key and pressing **[STOP]**. It is also possible to copy more than one trig. Press and hold the trigs you wish to copy, and then press **[RECORD]**. Press and hold the **[TRIG]** key to where you want to paste, and then press **[STOP]** to paste the copied sequence of trigs. When pasting, the copied trigs are placed in the same relation to each other as they had when they were copied. The destination trig acts as the starting point for the sequence of copied trigs. Clear trig locks by holding one or more trigs and press **[PLAY]**.

You can undo any copy, paste, and clear operation by repeating the key presses.



It is possible to copy, clear and paste one or several patterns without leaving the active pattern. First press **[PTN]**, then press **[TRIG]** + **[RECORD]** to select the pattern you wish to copy and copy it. Then press **[TRIG]** + **[STOP]** to paste the copied pattern to where you wish to paste it. Press **[TRIG]** + **[PLAY]** to clear the selected pattern.

10.12.6 TEMPORARY SAVE AND RELOAD PATTERN COMMANDS

Patterns can instantly be saved to a temporary memory space and then reloaded again from this space.

- Press **[FUNC]** + **[YES]** to perform a temporary save of the active pattern. This is useful in order to create a restore point when you are live tweaking, but without permanently save your changes.
- Press **[FUNC]** + **[NO]** to reload a pattern that was previously temporarily saved. It will reload the pattern from when you last used the temporary save command. If you have not done any temporary save, then the pattern will reload from the permanently saved state.



The **TEMPORARY SAVE PATTERN** and **TEMPORARY RELOAD PATTERN** commands are great when improvising live. Any changes made to the active pattern, like adding bass line notes or using **CONTROL ALL**, can immediately be undone. And at the same time, the saves and reloads will not affect the pattern in a permanent way.



The **TEMPORARY SAVE PATTERN** command will not save the pattern permanently and any changes will be lost if you load another project. If you wish to save your changes permanently, you should use **SAVE TO PROJ** in the **PATTERN MENU**. For more information, please see “13.3 PATTERN MENU” on page 71.

10.12.7 TRACK TRANSPOSE

1. Press and hold **[FUNC]** and then press **[+]/[-]** to initiate transpose of the active track in semitones. Press and hold **[TRK] + [FUNC]** and then press **[+]/[-]** to initiate transpose of the active track in octaves.
2. Release **[FUNC]** (or **[TRK] + [FUNC]**) for the transpose to take effect.

10.12.8 PATTERN TRANSPOSE

1. Press and hold **[PTN]** and then press **[+]/[-]** to initiate transpose of all the tracks in the pattern in semitones. Press and hold **[PTN] + [FUNC]** and then press **[+]/[-]** to initiate transpose all the tracks in the pattern in octaves.
2. Release **[PTN]** (or **[PTN] + [FUNC]**) for the transpose to take effect.

You can select which tracks that will be affected by pattern transpose. For more information, please see “9.6.1 KIT” on page 34.

10.12.9 SELECTED TRACKS TRANSPOSE

You can also select which tracks in the pattern are affected by the transposition. This is set up similarly to the **CONTROL ALL** functionality.

1. Press **[FUNC] + [FLTR]** to open the **SETUP** menu. Use the **[UP]** and **[DOWN]** arrow keys to select **TRANSPOSE ALL CONFIG**. Press **[YES]** to confirm your selection.
2. Use the **[TRIG]** keys to select which tracks that you want to be affected by the transposition. MIDI tracks can not be selected.



3. Press and hold **[TRK]** and then press **[+]/[-]** to initiate transpose of all the selected tracks in the pattern. The tracks are transposed up/down in semitones.
4. Release **[TRK]** for the transpose to take effect.



These transpositions are non-destructive and does not change the trigs **NOTE** values.

10.13 SONG MODE

A song is an arrangement of patterns set up to play in sequence. Each row in the **SONG** mode arrangement can have separate settings for pattern, row repeat, row length, tempo, and mute. A song can be up to 99 rows in length, and each project can contain up to 16 songs.

10.13.1 THE SONG EDIT SCREEN

Press **[SONG]** and then press **[TRIG 1-16]** to select a song and enter **SONG** mode. Press **[FUNC] + [SONG]** to open the **SONG EDIT** screen. Use the **[ARROW]** keys to navigate the song rows and columns, highlighting the parameter you wish to edit, and then use **LEVEL/DATA** or any **DATA ENTRY** knob to edit the selected function.

#	LABEL	PTN	PLAY COUNT	LENGTH	TEMPO	MUTE
01	INTRO	A03	4	016	120.0	
02	VERSE	B12	2	064	120.0	
03	BRIDGE	A05	1	032	110.0	
04	CHORUS	C01	2	064	120.0	
05	VERSE	B12	2	032	120.0	
-	END:	STOP				

1. **SONG ROW** (Range 01–99)
2. **LABEL** lets you select a keyword for the row. The keyword is related to song structure, e.g., Verse, Chorus, and Fill. It can also be the name of the pattern.
3. **PTN** lets you select the pattern to be played on the row. Press **[FUNC]** while turning the knob to change banks quickly.
4. **ROW PLAY COUNT** The number of times the row plays before the song advances to the next row.
5. **ROW LENGTH** (measured in sequencer steps). This setting defines how many steps the sequencer plays from the selected pattern. The default value is the same as the pattern length. (Range: 2–1024, the last 25 values are written as K00–K24)
6. **ROW TEMPO** Here, you set the row's BPM per row. You can also choose to have one BPM for the whole song. By default, the row inherits the BPM and swing set in the pattern selected for the row. Press **[TEMPO]** to open the TEMPO menu for the currently selected row's pattern. Here you can also set the swing. You can also press **[YES]** while highlighting the BPM parameter to open the TEMPO menu. Selecting song tempo on any row overrides all the previously set row and pattern tempos. The swing settings are always set per row.
7. **SONG POINTER** Shows the current time and position of the playhead in the song arrangement.
8. **ROW MUTE** lets you mute the tracks of the pattern on the selected row. Highlight and press **[YES]** to edit. A mute icon is displayed in the rows that have tracks that are muted. Use the **[TRIG]** keys to mute and unmute the tracks. When selecting a pattern for the row, the row's mute state initially reflects the pattern's mute state
9. **END row**. This row is always added at the end of a song and determines what will happen when the song has played the last song row. By default, it is set to LOOP the song from the beginning and play it again, but it can also be set to STOP the song.
10. The currently selected row is highlighted between dotted lines. Use **[UP]** and **[DOWN]** to select row.
11. **PLAYHEAD** position shows the row currently playing (or set to play if the sequencer is stopped).
12. **SONG SLOT** and **SONG NAME**.

10.13.2 CREATING AND EDITING A SONG

1. Press **[SONG]** and then press **[TRIG 1–16]** to select a song and enter SONG mode.
2. Press **[FUNC]** + **[SONG]** to open the SONG EDIT screen.
3. If you selected an empty song slot, you are presented with a screen where you can choose:
 - INSERT ROW** Inserts the first row in the song. Press **[FUNC]** + **[DOWN]** to insert a row.
 - CREATE ROWS FROM CHAIN** Creates a song based on a chain. Press **[YES]** and then select to create rows from a previously created chain or to create a new chain by selecting patterns using the **[TRIG 1–16]** keys. Use **[LEFT]/[RIGHT]** to change bank. Then press **[YES]** to create a song based on the chain and open the SONG EDIT screen.
4. Press **[FUNC]** + **[DOWN]** if you want to add a new row to the song arrangement. The new row is added below the currently selected row and is a copy of the selected row. Press **[FUNC]** + **[UP]** to remove the selected row from the song arrangement.
5. Use the **[ARROW]** keys to navigate the song rows and columns, highlighting the item you wish to edit. For more information about editing the functions in SONG mode, please see "10.13.1 THE SONG EDIT SCREEN" on page 51.
6. To rename the song, navigate to **SETTINGS > SONG > RENAME**, and then edit the song name.
7. Press **[NO]** or **[FUNC]** + **[SONG]** to exit the SONG EDIT screen.



- [FUNC] + [RECORD] copies the selected row.
[FUNC] + [STOP] pastes a previously copied row to the selected row.
[FUNC] + [PLAY] resets the selected row to the pattern's default BPM, length, and mute state settings.
[FUNC] + [UP] deletes the selected row.
- Please note that there is always a row called END at the song's end. This row can be set to either STOP the song or LOOP it from the beginning and play it again.
- On the SONG EDIT screen, you can select a song row number and then press YES to move the playhead to this row. You can also use the [TRIG 1-16] keys to preview and play the track presets from the pattern on the playhead row.

10.13.3 PLAYING A SONG

1. Press [SONG] and then press [TRIG 1-16] to select a song and enter SONG mode. The song selected will be the one that was last played or edited.
2. Press [PLAY] to play the selected song. At the top of the screen, you see the song number, the row currently playing, the total number of rows in the song, the row's LABEL, and finally the patterns bank/number. This part of the screen is also used as a progress bar to show how far in the row the song pointer has progressed.



3. Press [STOP] to stop the playback. You can then press [PLAY] to continue to play the song from the current playhead position. Press [STOP] twice to move the playhead to the song's beginning.
4. To exit song mode, press [PTN] + [TRIG 1-16] to return to pattern mode.



- Press [SONG MODE] + [LEFT] (when in SONG mode) to loop the currently playing row. Press [SONG MODE] + [LEFT] again (when in SONG mode) to stop looping the row and return to normal song playback.
- Press [SONG MODE] + [UP]/[DOWN] (when in SONG mode) to select a specific song row to jump to and to play next.
- Press [PTN] and the [TRIG 1-16] keys to select a pattern to exit SONG mode and return to regular pattern play.



The songs are automatically saved as they are created and edited. However, you must save the project if you wish to keep the songs before switching to another project.

10.14 PERFORM KIT MODE

In PERFORM KIT mode, any changes made to the preset parameters are not auto-saved, and kits are not loaded when you change the pattern; instead, you keep the previous (tweaked) kit. It means you can keep your parameter tweaks over several patterns and have a smooth evolving performance without having the kits reloaded or inadvertently saving your kit when you change patterns.

Press [FUNC] + [PRESET/KIT] to toggle PERFORM KIT mode on/off. When PERFORM KIT mode is on, a flashing "P" is shown next to the pattern name on the screen and the [PRESET/KIT] key is lit orange.



10.14.1 PERFORM KIT MODE ACTIONS

- Press [PRESET/KIT] + [NO] to reload the current patterns kit instantly.
- Press [PRESET/KIT] + [YES] to save the current patterns modified kit. This will open the SAVE (KIT) menu. For more information please see “9.2.6 SAVE (KIT)” on page 32.



Pattern Temp save and Temp reload still works while in PERFORM KIT mode



Actions done in PERFORM KIT mode are not saved and will not remain when switching the device off. Saving the pattern will not save any changes done in PERFORM KIT mode.

11. TRACK PARAMETERS

Here follows a description of all of the parameters that are available on the audio tracks **PARAMETER** pages. The parameters on the **TRIG** page are not saved together with the preset, but are instead saved with the pattern. The track parameters may be locked to other settings on any step of the pattern by first pressing and holding a **[TRIG]** key, then changing the parameters' settings with the **DATA ENTRY** knobs. For more information, please see "10.12.1 PARAMETER LOCKS" on page 48.



Please note that MIDI tracks have a different set of parameters on the **TRIG**, **SYN**, **FLTR**, and **AMP** pages. For more information, please see "A.2 SYN MACHINES" on page 87.

11.1 EDITING THE TRACK PARAMETERS

There are six **PARAMETER** pages for the tracks. Press the **[PARAMETER]** keys to access the tracks **PARAMETER** pages. Use the **[UP]/[DOWN]** keys to access the parameter group's pages. You can also press a **[PARAMETER]** key repeatedly to cycle through the parameter pages in that group. Press and hold a **[PARAMETER]** key to see the values for all parameters on that page.



- You can always reload a preset from its last saved state. Press **[TRK] + [TRIG 1-16] + [NO]** to reload the preset.
- You can also randomize the parameter settings on a specific **PARAMETER** page on an audio track. Press **[PARAMETER]** key + **[YES]** to randomize the relevant parameters on that page. Every time you press this key combination, the parameters randomize in a new way.
- Press **[PARAMETER]** key + **[NO]** to reset the **PARAMETER** page to its last saved state.

11.2 TRIG PAGE 1

Here you set the options for notes that are triggered. This is also where you select trig conditions. Press the **[TRIG PARAMETERS]** key to access the menu. Change settings using the **DATA ENTRY** knobs. These general settings affect note trigs placed on the sequencer.



NOTE

Trig Note sets the pitch of the note when triggered. When in **LIVE RECORDING** mode and playing in **KEYBOARD** mode, the pitch of the **[TRIG]** keys played will override this setting. Press and turn **DATA ENTRY** knob **A** to select only note values that exist in the scale set by **KB SCALE**. This behavior can be inverted using the **NOTE PARAM** setting in the **PERSONALIZE** menu. For more information, please see "13.7.6 NOTE PARAM" on page 77 and "8.5.2 KEYBOARD SETUP MENU" on page 24.

VEL

Trig Velocity sets the velocity of the sequencer's note trigs.

LEN

Trig Length sets the length of the note trig. In **LIVE RECORDING** mode, the duration of pressing the **[TRIG]** keys overrides this general setting.

PROB

Trig Probability sets the probability that the trigs on the track plays or not. The probability outcome is re-evaluated every time a trig is set to play. The default setting is 100%, meaning that all the trigs on the track plays every time. This parameter can be parameter locked which lets you give separate trigs their own probability.

LFO.T

LFO Trig controls if the LFO will be triggered or not.

FLT.T

Filter Trig controls if the filter envelope will be triggered or not.

FILL

Fill is a separate trig condition that determines if a trig is active (plays) or not depending on if the device is in FILL mode or not. For more information, please see “10.12.4 FILL MODE” on page 50, and “10.12.3 TRIG CONDITIONS AND CONDITIONAL LOCKS” on page 49.

ON, A trig with **FILL** set to ON, plays when FILL mode is active.

OFF, A trig with **FILL** set to OFF plays when FILL mode is not active.

 The sequencer needs to be in FILL mode to activate the FILL trig condition. For more information, please see “10.12.4 FILL MODE” on page 50.

COND

(Trig Condition) when you add a conditional lock, **COND** sets the Trig Condition with which a set of conditional rules can be applied to any trig, using a conditional parameter lock. For more information, please see “10.12.3 TRIG CONDITIONS AND CONDITIONAL LOCKS” on page 49.

11.3 TRIG PAGE 2

Here you set the behavior of retrigs that are added to note trigs placed in the sequencer. On this page you also control the portamento. Change settings using the **DATA ENTRY** knobs. These general settings all affect note trigs placed in the sequencer.

Retrigs can be customized on any of the sequencer steps on the audio tracks (the retrigger function is not available on the MIDI tracks). In GRID RECORDING mode, press [**TRIG PARAMETERS**] twice to access the RETRIG PARAMETERS page. Hold one or several [**TRIG**] keys and then set the desired retrigger options for the trig(s). The RETRIG PARAMETERS page shows the retrigger actions for the chosen sequencer step(s) on the active track. The retrigger settings are stored in the active pattern.



RTRG

Retrig enables a number of trig repeats on placed trigs. Use **DATA ENTRY** knob **A** to turn retrigger on/off. For information on setting retrigger locks on specific trigs in the sequencer, please see “10.9 RETRIGS” on page 46.

VFAD

Velocity Fade sets the velocity curve fade out/fade in of the retrigger (-64–64). -64 corresponds to a complete fade out during the set length, -32 fades out to half the velocity during the set length, 0 equals a flat velocity curve with no fade, 32 fades into half velocity during the set length and 64 fades in completely to full velocity during the set length. Please note that the effects of the **VFAD** setting is also dependent on the **VEL** setting on TRIG PAGE 1.

LEN

Length sets the duration of the retrigger velocity curve in fractions of, or rational or integer multiples of, a step (0,125–INF). 1/16 is the nominal length of one step. This setting affects the behavior of the velocity curve by defining the boundaries of its envelope.

RATE

Rate sets the retrigger rate. 1/16 is the nominal retrigger rate, one trig per step. 1/32 corresponds to two trigs per step and so on. To do triplets, for example, set the retrigger rate to 1/12 (or 1/24).

PTIM

Portamento Time sets the time for the portamento.

PORT

Portamento turns the portamento on/off. Please note that this parameter is only available on audio tracks.

For more information, please see “9.6.2 TRACK” on page 35.

11.4 SYN PAGES

The parameters on the SYN pages control the selected SYN machine, and these parameters vary depending on what machine is selected. The SYN machines are different synthesis engines with unique functionality. In the SYN machine section you also find the MIDI machine that lets you control external, MIDI equipped, gear. You can assign any SYN machine to any track. For more information, please see “A.2 SYN MACHINES” on page 87.

Press [SYN] to access these parameter pages.

The screen shot shows the first page for the FM Tone machine.

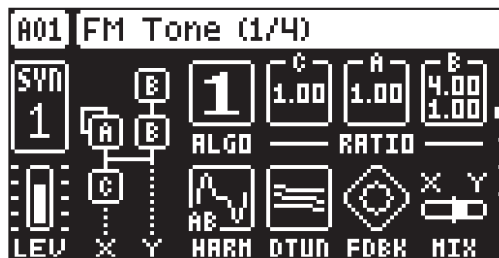

11.5 FLTR PAGE 1

The parameters on the FLTR page 1 control the filter, and these parameters vary depending on what FLTR machine is selected. The FLTR machines are a collection of different filters and EQ. On this page you also find the filter envelope. For more information, please see “A.3 FLTR MACHINES” on page 100.

Press [FLTR] to access this parameter page.

The screen shot shows the page for the Multi-mode FLTR machine.

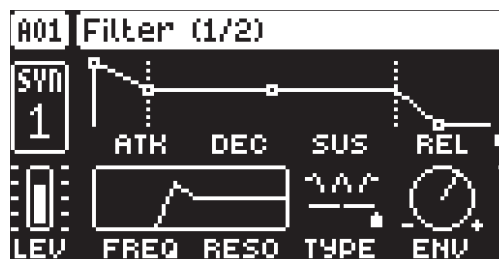

11.6 FLTR PAGE 2

On FLTR page 2, you will find the parameters that control the base-width filter and a number of parameters that affects the selected filter machine on FLTR page 1.

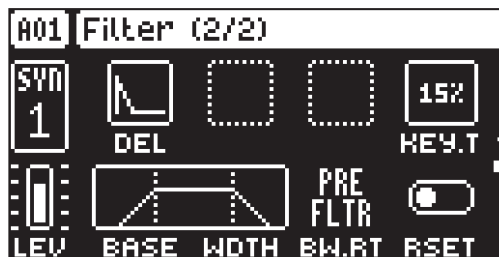

The base-width filter is basically a Highpass filter and a Lowpass filter connected in tandem. The filters **BASE** and **WDT** parameters define the base-width filters frequency range.

11. TRACK PARAMETERS

Examples of how the **BASE** and **WDTH** parameters affect the filter frequency range:

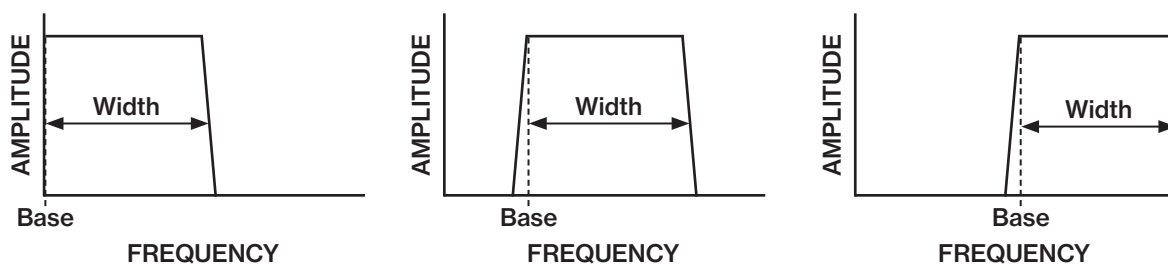

- With **BASE** set to 0, the filter functions as a low pass filter with **WDTH** adjusting the frequency range.
- With **WDTH** set to 127, the filter functions as a high pass filter with **BASE** adjusting the frequency range.
- With **WDTH** set to 0, the filter functions as a band pass filter with **BASE** adjusting the frequency.
- With **BASE** set to 0 and **WDTH** set to 127 the filter does not affect the sound.

DEL

Envelope delay sets the time before the attack phase of the filter envelope starts. This parameter is part of the filter envelope that controls the FLTR machine. You can also press and hold **[FUNC]** and then turn **DATA ENTRY** knob A to quickly access this parameter from FLTR page 1. This parameter only affects the selected filter machine on FLTR page 1.

KEY.T

Keytrack sets how much the filter cutoff frequency is affected by what note is playing. The higher the **KEY.T** setting, the more the filter opens up at higher notes. This parameter only affects the selected filter machine on FLTR page 1.

BASE

Sets the base frequency of the filter.

WDTH

Sets the frequency width above the base frequency.

BW.RT

BW Routing selects if the base-width filter should be routed before (Pre) or after (Post) the machine selectable filter in the audio path.

RSET

Filter Envelope Reset sets the filter envelope behavior. This parameter only affects the selected filter machine on FLTR page 1.

ON resets the envelope for each consecutive trig (default). The envelopes attack phase is reset to zero.

OFF does not reset the envelope for each consecutive trig. The envelopes attack phase continues from where it was left off.

11.7 AMP PAGE

The AMP page controls parameters for the amplitude envelope, panning, and volume.

Press **[AMP]** to access this parameter page.

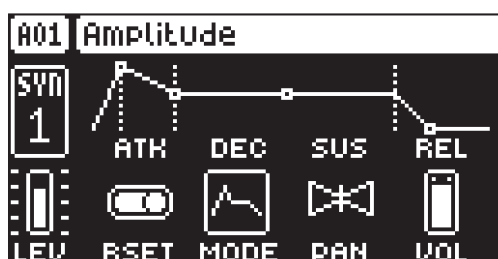

ATK

Attack Time sets the length of the attack phase of the amp envelope.

HOLD

Hold Time sets the length of the hold phase of the amp envelope. Fixed Hold time values (0–126) specify the length of the hold phase, and the envelope ignores Note Off events such as Trig Length, releasing a [TRIG] key or a key on an external controller. Setting **HOLD** to NOTE means the hold phase will be determined by Note On and Note Off events. This parameter is only available if **MODE** is set to AHD.



If you set **HOLD** to **NOTE** and use an external keyboard to trigger the envelope, then the sound will be sustained (if **DEC** is set to less than 127) for as long as you press a key on the keyboard.

DEC

Decay Time sets the length of the decay phase of the amp envelope.

SUS

Sustain Level sets the sustain level of the amp envelope. This parameter is only available if **MODE** on is set to ADSR.

REL

Release Time sets the length of the release phase of the amp envelope. This parameter is only available if **MODE** is set to ADSR.

RSET

Amp envelope reset sets the amp envelope behavior:

ON resets the envelope for each consecutive trig (default). The envelopes attack phase is reset to zero.

OFF does not reset the envelopes for each consecutive trig. The envelopes attack phase continues from where it was left off..

MODE

Envelope mode sets the amplitude envelope to function as an AHD or an ADSR envelope.

PAN

Pan positions the audio in the stereo field.

VOL

Volume sets the volume amount of the amplifier. Unlike the track **LEVEL**, this parameter can be parameter locked. and is saved with the preset.

Amplitude envelope with **MODE** set to AHD and a fixed **HOLD** time.

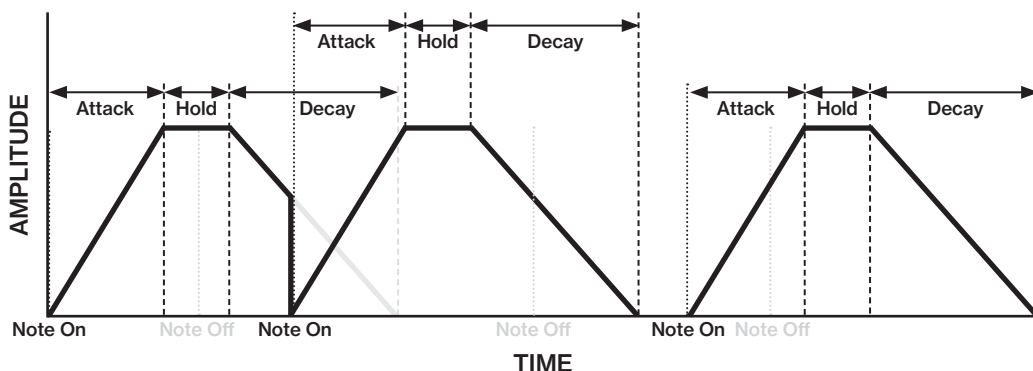

Amplitude envelope with **MODE** set to AHD and **HOLD** set to NOTE.

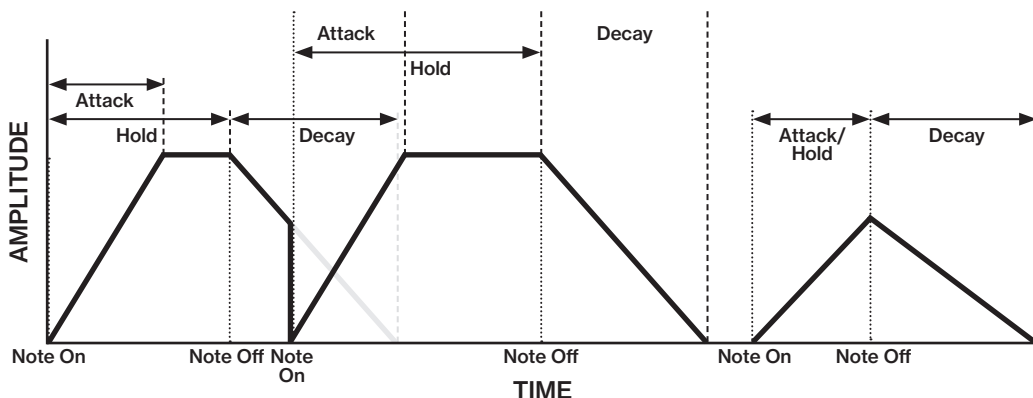

11.8 FX PAGE

The FX parameter page contains a number of FX related parameters such as the Bit Reduction, Overdrive, and Sample Rate Reduction. Here you also find the send levels for the Delay, Reverb, and Chorus effects.

Press **[FX]** to access this parameter page.



BR

Bit Reduction sets the bit depth. The parameter range is from 16 bits to 1 bit.

OVER

Overdrive sets the gain amount into the digital overdrive.

SRR

Sample Rate Reduction sets the amount of sample rate reduction.

SR.RT

SRR Routing sets if the Sample Rate Reduction effect is routed before (PRE) or after (POST) the filter machine.

DEL

Delay Send sets the amount of sound sent through to the Delay effect. For more information, please see "12. FX AND MIXER PARAMETERS" on page 63.

REV

Reverb Send sets the amount of sound sent through to the Reverb effect. For more information, please see "12. FX AND MIXER PARAMETERS" on page 63.

CHR

Chorus Send sets the amount of sound sent through to the Chorus effect. For more information, please see "12. FX AND MIXER PARAMETERS" on page 63.

OD.RT

Overdrive Routing selects if the overdrive effect is routed before (PRE) or after (POST) the filter machine.



Please note that there are no parameters on the FX page for MIDI tracks.

11.9 MOD PAGE 1

The MOD pages contain three LFOs (two for tracks that use MIDI machines). The Low-Frequency Oscillator can be used to modulate track parameters. Customize the low-frequency oscillator behavior, orientation, speed, and depth on this page. This page controls the behavior of LFO 1

Press [MOD] to access this parameter page.

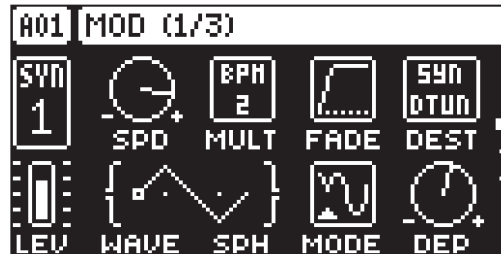

SPD

Speed sets the speed of the LFO. Try settings of 8, 16 or 32 to sync the LFO to straight beats. The knob is bipolar. The LFO cycle can be played backward by using negative values.

MULT

Multiplier multiplies the SPD parameter by the set factor either by multiplying the current tempo (BPM settings), or by multiplying a fixed tempo of 120 BPM.

FADE

Fade In/Out makes it possible to fade in/fade out the LFO modulation. The knob is bipolar. Positive values give a fade-out, negative values give a fade in. 0 gives no fade in/fade out. (-64-63)

DEST

Destination selects the modulation destination for the LFO. Preview how the LFO modulation will affect the sound by highlighting a destination. Press [YES] to confirm the selection. Press [NO] to cancel and revert to previous selection For more information, please see "APPENDIX D: LFO MODULATION DESTINATIONS" on page 117

WAVE

Waveform sets the LFO waveform. The Triangle, Sine, Square, Sawtooth, and Random waveforms are bipolar. The Exponential and Ramp are unipolar.

SPH

Start Phase sets the point within the wave cycle where the LFO will start when it is triggered. 0 makes the LFO start at the beginning of a complete wave cycle, 64 makes it start at the center. A small square at the start of the waveform shows that the wave cycle starts at a zero-crossing. If **WAV** is set to RND then the **SPH** parameter changes to **SLEW** and adds slew to the transitions in the waveform.

MODE

Trig Mode sets how the LFO will act when a note is triggered.

- **FREE** is the default free-running mode. It makes the LFO run continuously, never restarting or stopping even if notes are triggered.
- **TRIG** makes the LFO restart when a note is triggered.
- **HOLD** makes the LFO run free in the background, but when a note is triggered the LFO output level is latched and held still until the next note is triggered.
- **ONE** The LFO starts when a note is triggered, then runs to the end of the waveform and then stops. This makes the LFO function similar to an envelope.
- **HALF** The LFO starts when a note is triggered, then runs to the middle of the waveform and then stops.

DEP

Depth sets the depth and polarity of the LFO modulation. Both negative and positive modulation depth is possible. A center setting, 0.00, equals no modulation depth.

11.10 MOD PAGE 2

MOD page 2 page contains the same parameters as LFO page 1, but controls the behavior of LFO 2.

11.11 MOD PAGE 3

MOD page 3 page contains the same parameters as LFO page 1, but controls the behavior of LFO 3.

 Please note that MIDI tracks only have two LFOs.

LFO waveforms and trig modes.

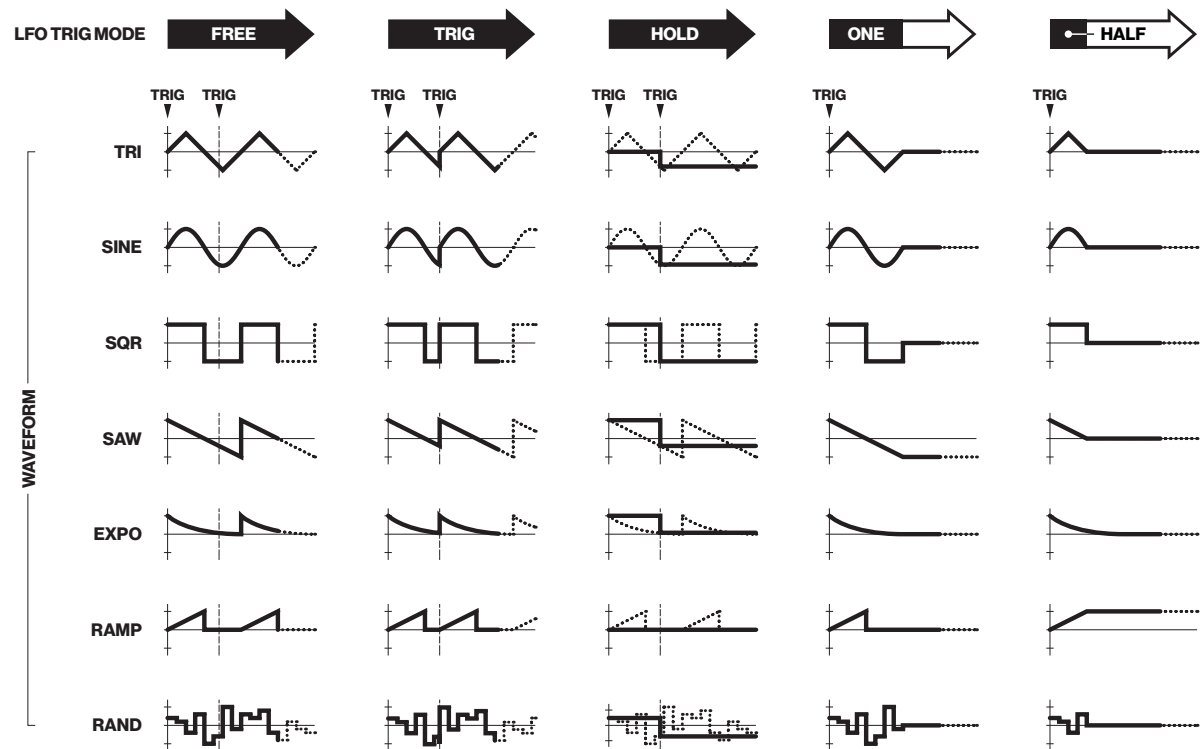

The table below shows the LFO speed measured in sequencer steps using different combinations of SPD and MULT (set to a BPM value) settings. For example, a value of 8 in the table means that the LFO will do one full cycle in the time it takes the sequencer to advance eight steps.

		MULT											
		1	2	4	8	16	32	64	128	256	512	1K	2K
SPD	1	128	64	32	16	8	4	2	1	1/2	1/4	1/8	1/16
	2	64	32	16	8	4	2	1	1/2	1/4	1/8	1/16	1/32
	4	32	16	8	4	2	1	1/2	1/4	1/8	1/16	1/32	1/64
	8	16	8	4	2	1	1/2	1/4	1/8	1/16	1/32	1/64	1/128
	16	8	4	2	1	1/2	1/4	1/8	1/16	1/32	1/64	1/128	1/256
	32	4	2	1	1/2	1/4	1/8	1/16	1/32	1/64	1/128	1/256	1/512
	64	2	1	1/2	1/4	1/8	1/16	1/32	1/64	1/128	1/256	1/512	1/1024

12. FX AND MIXER PARAMETERS

The Digitone II effects and mixers parameters are explained in this chapter.

12.1 EDITING THE SEND FX AND MIXER PARAMETERS

The Digitone II's Chorus, Delay and Reverb are send effects and are set on a pattern level. It means that all the presets in a pattern shares the same effect settings but have individual send levels to the effects. The Delay, Reverb, and Chorus parameters are set on their respective PARAMETER page, but their incoming signals are set by the DEL, REV, and CHO send parameters on the FX page of each audio track.

Press **[FUNC] + [FX]** to access the SEND FX parameter pages, and then use the **[UP]/[DOWN]** keys to navigate between the sub pages. Use the **DATA ENTRY** knobs **A-H** to change the parameters.

Press **[FUNC] + [MOD]** to access the MIXER parameter pages, and then use the **[UP]/[DOWN]** keys to navigate between the sub pages. Use the **DATA ENTRY** knobs **A-H** to change the parameters.



The FX and MIXER parameter settings are stored as part of the pattern. Don't forget to save the pattern and give it a unique name once you have achieved the results you want.

12.2 DELAY

(SEND FX PAGE 1)

The Delay send effect takes the input signal, delays it in time and then rejoins it with the original signal.

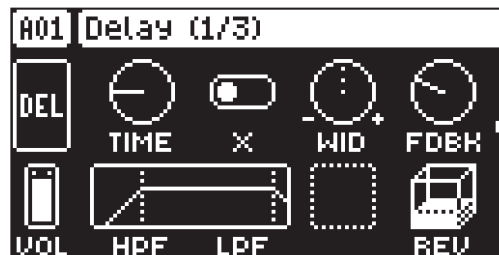

TIME

Delay Time sets the delay time. It is relative to the current BPM and is measured in 128th notes.

TIME setting	Divide ratio
1	1/128
2	1/64
2.67	1/48 (1/32T)
3	1/64.
4	1/32
5.33	1/24 (1/16T)
6	1/32.
8	1/16
10.67	1/12 (1/8T)
12	1/16.
16	1/8
21.33	1/6 (1/4T)
24	1/8.
32	1/4
42.67	1/3 (1/2T)
48	1/4.
64	1/2
96	1/2.
128	1

X

Ping-pong sets the delay signal to alternate across the stereo field. There are two settings:

- **OFF** lets you manually set the position of the delay signal in the stereo field. Use the **WID** parameter to change the stereo field position.
- **ON** makes the delay signal alternate between left and right pan positions. The **WID** parameter controls the amount of panning.

WID

Stereo Width sets the delay signal pan width across the stereo field. The knob is bipolar.

FDBK

Feedback Gain sets the amount of delay output signal to feed back into the input of the delay. With higher parameter settings, infinite and/or swelling delays are possible. Please be aware that high feedback can lead to a very loud signal.

VOL

Delay Volume sets the volume of the Delay output signal. Use **LEVEL/DATA** to set this parameter.

HPF

HPF sets the cutoff frequency of the delay highpass filter.

LPF

LPF sets the cutoff frequency of the delay lowpass filter.

REV

Reverb Send sets the amount of Delay output signal to be sent to the Reverb.

12.3 REVERB

(SEND FX PAGE 2)

The Reverb send effect controls the persistence, and ambient characteristics, of the sound reverberations. It can simulate many different sonic locations, from huge spaces to small rooms.

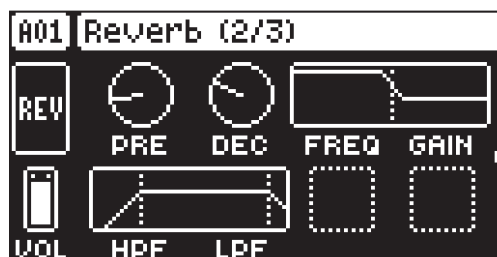

PRE

Pre-delay sets the pre-delay time of the Reverb.

DEC

Decay Time sets the length of the decay phase of the reverberated signal, essentially setting the size of the simulated acoustic space.

FREQ

FB Shelving Freq sets the shelving filter frequency. Together with the **GAIN** parameter, it can be used to dampen the reverberated signal above a chosen frequency, making the reverberation sound more prominent or more muffled.

GAIN

FB Shelving Gain affects the damping of the reverberated signal above the shelving frequency set by the **FREQ** parameter. At max value the treble is included in the reverberations; lowering the value gradually dampens it.

VOL

Reverb Volume sets the volume of the Reverb output signal. Use **LEVEL/DATA** to set this parameter.

HPF

HPF sets the cutoff frequency of the reverb high-pass filter that affects the audio going into the reverb.

LPF

LPF sets the cutoff frequency of the reverb low-pass filter that affects the audio going into the reverb.

12.4 CHORUS

(SEND FX PAGE 3)

The chorus can be used to widen sounds, enhance the stereo image or add subtle movement to sounds.

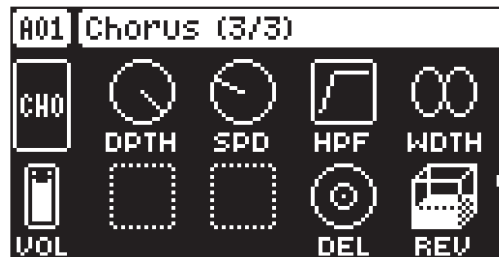
**DPTH**

Depth sets the depth of the LFO modulation of the chorus.

SPD

Speed sets the speed of the LFO modulation of the chorus.

HPF

High-pass filter sets the highpass filtering of the input signal.

WPTH

Width sets the stereo width of the chorus.

VOL

Chorus Volume sets the volume of the Chorus output signal. Use *LEVEL/DATA* to set this parameter.

DEL

Delay Send sets how much of the wet chorus signal to send through to the delay.

REV

Reverb Send sets how much of the wet chorus signal to send through to the reverb.

12.5 COMPRESSOR

(MIXER PAGE 1)

The Compressor master effect compresses the dynamic range of the signal by reducing the volume of loud sounds relative to the quiet sounds. There are eight parameters with which the compressor is customized on this page. There is a bar on the left side of the screen that visually represents the amount gain reduction

**THR**

Threshold sets the threshold of the compressor. A lower threshold means a larger portion of the signal is subject to compression.

ATK

Attack sets the time of the compressor attack phase, i.e. how quickly the compressor responds to loud peaks.

REL

Release sets the time of the compressor release phase, i.e. how long it takes for the compression to recover in quieter moments.

MUP

Makeup Gain sets the makeup gain of the compressor output, to compensate for the reduced signal levels caused by compression. The Makeup Gain parameter value is displayed in dB.

VOL

Pattern Volume sets the kits overall audio level. This parameter basically has the same function as the **MAIN VOLUME** knob, but is saved together with the kit. Use **LEVEL/DATA** to adjust the settings.

RAT

Compression Ratio. There are eight different compression ratios, 1.50, 2.00, 3.00, 4.00, 6.00, 8.00, 16.00 and 20.00. Higher ratios result in greater compression of the signal.

SCS

Sidechain Source decides what audio source the compressor analyzes when it performs sidechaining. Sidechaining is the process when the compressor uses the output of an audio source to control the overall action of the compressor. For example, if you set **SCS** to TRK1 where you have a kick drum, every time the kick drum plays, the compressor lowers the overall sound of the mix.

COMP MIX sets the sidechain source to be all the tracks that are routed to the compressor.

COMP (Not Comp) sets the sidechain source to be all the tracks that are not routed to the compressor.

TRK1-16 sets the sidechain source to be the sound sent from one of the separate audio tracks.

IN LR sets the sidechain source to be the sound coming from IN L/R.

IN L sets the sidechain source to be the sound coming from INPUT L.

IN R sets the sidechain source to be the sound coming from INPUT R.



- The results of the COMP MIX and NOT COMP settings depends on the selections you make on the COMPRESSOR ROUTING page. For more information please see “9.6.1 KIT” on page 34.
- The IN L and IN R options are only available if you set DUAL on the External mixer page to ON. The IN LR option is only available if you set DUAL to OFF. For more information, please see “12.9 EXTERNAL MIXER” on page 68.

SCF

Sidechain Filter filters the signal from the sidechain source before the compressor analyzes it. The parameter ranges from a low-pass filter to a high-pass filter. Negative parameter values set a low-pass filter. Positive parameter values set a high-pass filter.

When set as a low-pass filter, the compressor reacts mostly to bass frequencies. Use this setting for a characteristic pumping compressor sound. When set as a high-pass filter, the compressor reacts less to bass frequencies. Use this setting to avoid pumping.

DRY/WET MIX

Dry/Wet Mix sets the mix of the uncompressed signal and the compressor output signal. A setting of 0 results in a completely uncompressed signal. A setting of 127 lets only the compressed signal pass through. All values in between mix the uncompressed signal with the compressed signal, which is known as parallel compression.

The Digitone II compressor

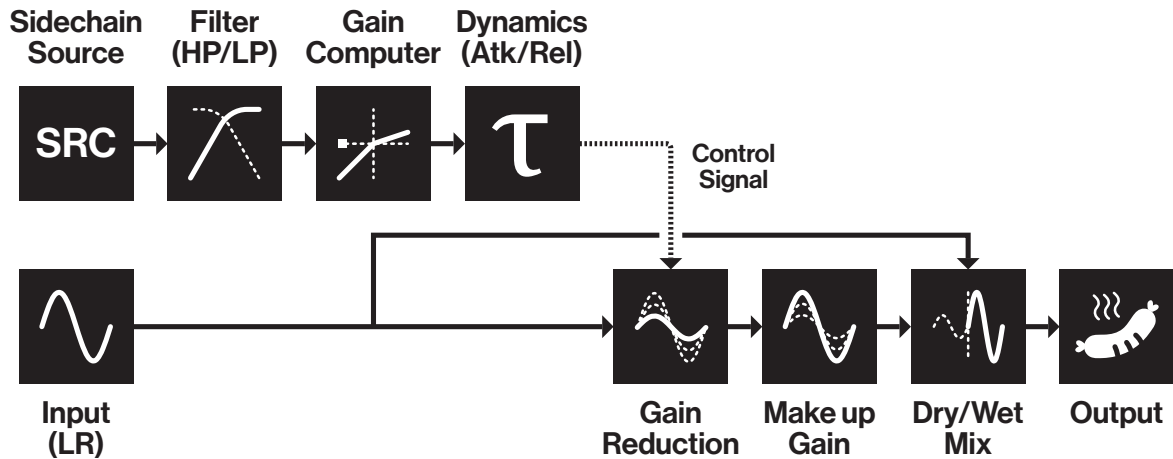

12.6 INTERNAL MIXER PAGE 1

(MIXER PAGE 2)

The INTERNAL MIXER page 1 is where you can access the **TRACK LEVEL** parameter of track 1–8 (if they are audio tracks).



VOL

Pattern Volume sets the patterns overall audio level. At a parameter setting of 100, you have unity gain. Below that, the signal is attenuated. Above that, the signal is amplified. This parameter can be used to balance the volume between different patterns and is saved together with the kit. Use **LEVEL/DATA** to adjust the settings.

12.7 INTERNAL MIXER PAGE 2

(MIXER PAGE 3)

The INTERNAL MIXER page 2 is where you can access the **TRACK LEVEL** parameter of track 9–16 (if they are audio tracks).



VOL

Pattern Volume sets the patterns overall audio level. At a parameter setting of 100, you have unity gain. Below that, the signal is attenuated. Above that, the signal is amplified. This parameter can be used to balance the volume between different patterns and is saved together with the kit. Use **LEVEL/DATA** to adjust the settings.

12.8 FX MIXER

(MIXER PAGE 4)

On the FX MIXER page you can set the levels of the send effects and master overdrive.

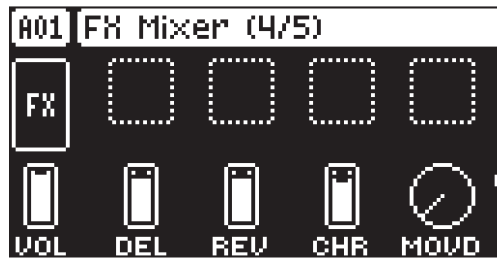

VOL

Pattern Volume sets the patterns overall audio level. At a parameter setting of 100, you have unity gain. Below that, the signal is attenuated. Above that, the signal is amplified. This parameter can be used to balance the volume between different patterns and is saved together with the kit. Use **LEVEL/DATA** to adjust the settings.

DEL

Delay Mix Volume Sets the master volume of the delay.

REV

Reverb Mix Volume sets the master volume of the reverb.

CHR

Chorus Mix Volume sets the master volume of the chorus.

MOVD

Master Overdrive sets overall amount of overdrive for the audio tracks in the kit. Use **LEVEL/DATA** to adjust the settings.

12.9 EXTERNAL MIXER

(MIXER PAGE 5)

The EXTERNAL MIXER page contains a number of parameters related to when you use the **IN L/R** inputs to process incoming audio.



IN LR

In Level sets the level of the audio from the **IN L/R** audio input.

DUAL

Dual Mono sets if the inputs are processed as a single stereo input or as two separate mono inputs. Setting this parameter to ON changes the rest of the parameters from controlling both inputs to separate controls for channel L and R split over two mixer pages. The **BAL** parameter changes to a **PAN** parameter.

BAL

Balance sets the balance of the audio from the **INPUT L** and **INPUT R** inputs in the stereo field.

VOL

Pattern Volume sets the patterns overall audio level. At a parameter setting of 100, you have unity gain. Below that, the signal is attenuated. Above that, the signal is amplified. This parameter can be used to balance the volume between different patterns and is saved together with the kit. Use **LEVEL/DATA** to adjust the settings..

DEL

Delay send sets the amount of sound from the **IN L/R** audio input that is sent through to the delay effect. For more information, please see “12.2 DELAY” on page 63.

REV

Rev send sets the amount of sound from the **IN L/R** audio input that is sent through to the reverb effect. For more information, please see “12.3 REVERB” on page 64.

CHO

Chorus send sets the amount of sound from the **IN L/R** audio input that is sent through to the chorus effect. For more information, please see “12.4 CHORUS” on page 65.



If you set **DUAL** to **ON**, the first **EXTERNAL MIXER** page will control the audio from **INPUT L**. You also get an additional **EXTERNAL MIXER** page (6) that control the audio from **INPUT R**.



After you load/reload a project, or after pressing **[STOP] + [STOP]**, you must trig or play an audio track to activate the effects for the External in mixer.

13. SETTINGS MENU

The SETTINGS menu offers settings that affect Digitone II and can also be used to manage Projects.

Press [SETTINGS] to access the SETTINGS menu. Scroll the list by using [UP]/[DOWN] or the *LEVEL/DATA* knob. Open a highlighted menu by pressing [YES].



13.1 PROJECT

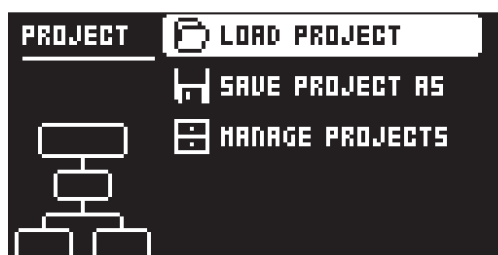

13.1.1 LOAD PROJECT

Load Project opens a project selection screen where you can choose a project to load. If you wish to create a new project, select CREATE NEW at the very bottom of the list. The new project will be a blank slate.



If you load a new project it will replace the active project. Be sure to save your active project before you load another project.

13.1.2 SAVE PROJECT AS

Save Project opens a project selection screen where you choose a slot to save the active project to. You can also press [FUNC] + [SETTINGS] to save and overwrite the current project.

13.1.3 MANAGE PROJECTS

Manage Projects launches the PROJECT MANAGER menu. Selecting a project in this menu and pressing the [RIGHT] arrow key will bring up a list of commands.

- **CLEAR** Resets the project slot to a clean state.
- **DELETE** Removes the project from the slot.
- **RENAME** Opens a NAMING screen where you can rename the project file.
- **LOAD FROM** Loads the selected project. This will replace the active project!
- **SAVE TO** Saves the active project to the selected slot.
- **TOGGLE** Toggles write protection on or off. Write protected projects cannot be overwritten, renamed or erased. A lock symbols in front of the project name shows that the project is write protected.
- **INIT NEW** Initializes an empty file slot with a clean project. This option is only available for empty project slots.
- **PURGE ALL** Purges (removes) all presets from the pool that are not used in any pattern in the project from the RAM memory. The presets are not removed from the +Drive library. This option is only available when you select the currently loaded project.

13.2 SONG

In this menu, you can perform tasks related to songs. For more information, please see “10.13 SONG MODE” on page 51.



13.2.1 RENAME

Opens the NAMING screen where you can rename the active song.

13.2.2 CLEAR

Clears the active song.

13.2.3 LOAD

Opens a screen where you can select and load songs

13.2.4 SAVE TO PROJ

Saves the active song to the project.

13.3 PATTERN MENU

Use the PATTERN menu to perform pattern management. Use the [UP] and [DOWN] arrow keys to move between the options. Press [YES] to confirm your selection. Press [NO] to exit the menu.



13.3.1 RENAME

Opens the NAMING screen where you can rename the active pattern.

13.3.2 CLEAR

- **WHOLE PATTERN** Clears the active pattern's sequencer data and kit. A prompt appears when you select this option. Press [YES] to clear, or [NO] to cancel the operation. Note that no pattern information will be permanently lost until the pattern is saved to the same pattern slot that it was loaded from.
- **KIT DATA** Clears the active pattern's kit. All sequencer data will remain unchanged. A prompt appears when you select this option. Press [YES] to clear, or [NO] to cancel the operation. Note that no kit information will be permanently lost until the pattern is saved to the same pattern slot that it was loaded from.
- **SEQUENCE DATA** Clears the active pattern's sequence data. All presets will remain unchanged. A prompt appears when you select this option. Press [YES] to clear, or [NO] to cancel the operation. Note that no sequencer information are permanently lost until the pattern is saved to the same pattern slot it was loaded from.

13.3.3 SAVE TO PROJ

You must have saved the project at least once before you can save pattern information.

- **WHOLE PATTERN** Saves the active pattern's sequence data and kit to the +Drive. A prompt appears when you select this option. Press [YES] to save, or [NO] to cancel the operation.
- **KIT DATA** Saves the active pattern's kit to the +Drive. A prompt appears when you select this option. Press [YES] to save, or [NO] to cancel the operation.

- **SEQUENCE DATA** Saves the active pattern's sequence data to the +Drive. A prompt appears when you select this option. Press **[YES]** to save, or **[NO]** to cancel the operation.

13.3.4 RELOAD FROM PROJ

You must have saved the pattern at least once before you can reload pattern information.

- **WHOLE PATTERN** Reloads the active pattern's sequence data and kit from the +Drive. A prompt will appear when you select this option. Press **[YES]** to reload, or **[NO]** to cancel the operation.
- **KIT DATA** Reloads the active pattern's kit from the +Drive. A prompt appears when you select this option. Press **[YES]** to reload, or **[NO]** to cancel the operation.
- **SEQUENCE DATA** Reloads the active pattern's all sequence data from the +Drive. A prompt appears when you select this option. Press **[YES]** to reload, or **[NO]** to cancel the operation.

13.4 MIDI CONFIG

In this menu, various sub-menus dealing with the MIDI functionality of Digitone II are found.



13.4.1 SYNC

Controls how Digitone II receives and sends MIDI clock and transport commands. Change settings by using the **[LEFT]/[RIGHT]** arrow keys or the **[YES]** key.



CLOCK RECEIVE sets whether or not Digitone II responds to MIDI clock sent from external devices.

CLOCK SEND sets whether or not Digitone II transmits MIDI clock.

TRANSPORT RECEIVE sets whether or not Digitone II responds to MIDI transport messages sent from external devices.

TRANSPORT SEND sets whether or not Digitone II transmits MIDI transport messages.

PRG CH RECEIVE will, when active, make Digitone II respond to incoming program change messages, which is useful when wanting to select patterns externally. The MIDI channel that will listen to incoming program change messages is set in the MIDI CHANNELS menu. For more information, please see "13.4.3 CHANNELS" on page 74.

PRG CH SEND will, when active, send program change messages when patterns are changed. The MIDI channel that will send program change messages is set in the MIDI CHANNELS menu. For more information, please see "13.4.3 CHANNELS" on page 74.

13.4.2 PORT CONFIG

Here you find the MIDI port related settings. Change settings by using the **[LEFT]/[RIGHT]** arrow keys.

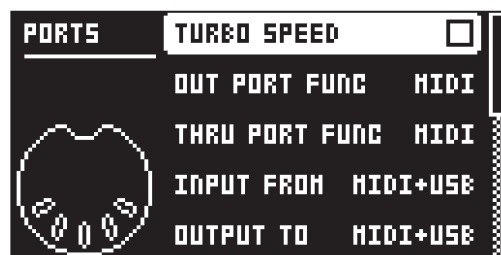

TURBO SPEED press [YES] to start the turbo speed negotiation. Speed is chosen automatically. Please note that you must use a MIDI interface that supports the Turbo-MIDI protocol.

OUT PORT FUNC selects what type of signal the MIDI OUT port will send.

- **MIDI** makes it possible for the port to send out MIDI data.
- **DIN 24** will make the port send DIN 24 sync pulses. No MIDI data is transferred over the port when this option is selected.
- **DIN 48** will make the port send DIN 48 sync pulses. No MIDI data is transferred over the port when this option is selected.

THRU PORT FUNC selects what type of signal the MIDI THRU port will send. The settings are the same as for OUT PORT FUNCTIONALITY.

INPUT FROM selects the source Digitone II will receive MIDI data from.

- **DISABLED** will make Digitone II disregard any incoming MIDI data.
- **MIDI** will make Digitone II listen only to MIDI data sent to the MIDI IN port.
- **USB** will make Digitone II listen only to MIDI data sent to the USB port.
- **MIDI+USB** will make Digitone II listen to MIDI data sent to both the MIDI IN and USB ports.

OUTPUT TO selects the destination to which Digitone II will send MIDI data.

- **DISABLED** will stop Digitone II from sending out any MIDI data.
- **MIDI** will make Digitone II send MIDI data to the MIDI OUT port only.
- **USB** will make Digitone II send MIDI data to the USB port only.
- **MIDI+USB** will make Digitone II send MIDI data to both the MIDI OUT and USB ports.



If **MIDI+USB** is selected in the **OUTPUT TO** settings, MIDI data will limit the USB speed. When sending large chunks of data, make sure you only use the USB setting.

OUTPUT CH selects whether the **DATA ENTRY** knobs will send data on the auto channel or the track channel.

PARAM OUTPUT selects what type of MIDI messages the **DATA ENTRY** knobs will send. For information about which CC/NRPN parameters that will be sent, please see “APPENDIX C: MIDI” on page 111.

- **CC** will make the knobs send out CC MIDI messages.
- **NRPN** will make the knobs send out NRPN MIDI messages.

ENCODER DEST controls whether the **DATA ENTRY** and **LEVEL/DATA** knobs sends MIDI data or not. When set to INT, the knobs only affects the Digitone II and no MIDI data is sent. When set to INT + EXT, the knobs affects the Digitone II and also sends MIDI data to external devices.

TRIG KEY DEST controls whether the [TRIG] keys sends MIDI data or not. When set to INT, the [TRIG] keys only affects the Digitone II and no MIDI data is sent. When set to INT + EXT, the [TRIG] keys affects the Digitone II, and also sends MIDI data to external devices. When set to EXT, the [TRIG] keys do not affect the Digitone II but MIDI data is sent externally.

MUTE DEST controls whether activating/deactivating mutes will send MIDI data or not. When set to INT, mute only affects the Digitone II and no MIDI data is sent. When set to INT + EXT, mute affects the Digitone II and also send MIDI data to external devices. When set to EXT, mute sends MIDI data externally, but do not affect the Digitone II.

RECEIVE NOTES will, when active, make it possible to play Digitone II using an external MIDI keyboard.

RECEIVE CC/NRPN will, when active make it possible to control Digitone II's parameters from an external MIDI device sending CC/NRPN data.

13.4.3 CHANNELS

This menu handles the MIDI channel configuration.



TRACK 1-16 selects the dedicated MIDI channel that is used to receive or send (by turning the knobs) parameter data to or from a specific audio track. If configured as OFF, parameter data are neither received nor sent via MIDI.



The sequencer data is always sent on the MIDI channel specified by the CHAN parameter on the SYN PARAMETER page.

FX CONTROL CH selects the dedicated MIDI channel that is associated with the parameters on the DELAY, REVERB, CHORUS, and COMPRESSOR parameter pages together with the master overdrive, both for input and output. If configured as OFF, parameter data are neither sent nor received via MIDI.

AUTO CHANNEL selects the MIDI channel that will give access to the currently active track. If an external MIDI keyboard connected to Digitone II sends MIDI data on this channel, the keyboard will control the active track. This is useful when for example quickly changing between the active audio tracks to play different presets. The Digitone II also uses the AUTO channel to record to the MIDI tracks from external MIDI controllers.

PROGRAM CHG IN CH selects the MIDI channel that will listen for incoming program change messages. An AUTO setting will use the AUTO channel. Enable Digitone II to respond to program change messages in the MIDI SYNC menu. For more information, please see “13.4.1 SYNC” on page 72.

PROGRAM CHG OUT CH selects the MIDI channel that will send program change messages when changing patterns. An AUTO setting will use the AUTO channel. Enable Digitone II to send program change messages in the MIDI SYNC. For more information, please see “13.4.1 SYNC” on page 72.

13.5 SYSEX DUMP

In the SYSEX DUMP menu, project, pattern, and preset data can be sent and received via the MIDI OUT port or the USB port of the Digitone II. Select a menu option using [UP]/[DOWN] or the **TRACK LEVEL** knob. Press [YES] to open the highlighted menu selection.



When receiving or sending SysEx data, the MIDI ports or the USB port of the Digitone II should be connected to the external sending/receiving device.

13.5.1 SYSEX SEND

Here projects, patterns, and presets can be sent to an external device.



The column to the left selects what will be backed up. Select the column using the **[LEFT]** arrow key. Use the **[UP]/[DOWN]** keys or the **LEVEL/DATA** knob to navigate in the column. The SysEx data send alternatives located in the column to the right will change depending on the selection made in the left column. Press the **[RIGHT]** arrow key to access this column. Use the **[UP]/[DOWN]** keys or the **LEVEL/DATA** knob to select what will be sent. Press **[YES]** to initiate the SysEx send procedure.

PROJECT will send the active project (settings, patterns, presets in the pool).

PATTERN will send the selected pattern.



- Backing up your data regularly is important!
- Before initiating a SysEx send, first, make sure the receiving device is listening for data to be sent.

13.5.2 SYSEX RECEIVE

Here projects, patterns, and presets can be received from an external device. Digitone II is continuously listening for SysEx data so you can at any time send backed up projects or patterns to the device.

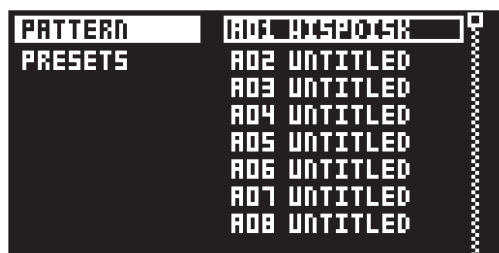

The column to the left selects what will be received. Select the column using the **[LEFT]** arrow key. Use the **[UP]/[DOWN]** keys or the **LEVEL/DATA** knob to navigate in the column. The SysEx data receive alternatives located in the column to the right will change depending on the selection made in the left column. Press the **[RIGHT]** arrow key to access this column. Use the **[UP]/[DOWN]** keys or the **LEVEL/DATA** knob to select what will be received. Press **[YES]** to initiate the SysEx receive procedure. The Digitone II starts listening to incoming data. Press **[NO]** to stop listening.

PATTERN will store a received pattern to the selected pattern slot.

PRESETS will store a received preset to the selected slot of the +Drive library. The option ANY-WHERE will place the preset in the first free slot available. To the right of the bank indication, the amount of free slots can be seen.

13.6 AUDIO ROUTING

Here you find number of audio routing options that affects the Digitone II on a global level.



13.6.1 TO MAIN

Use this option to customize which of the 16 tracks, 3 effects (Delay, Reverb, Chorus), and inputs that will send audio to the MAIN OUT outputs. Use **[UP]/[DOWN]** to switch between the setup pages. Use the **[TRIG]** keys to activate/deactivate the tracks, effects, and inputs that can send to main. Green keys signal send to main. Unlit keys signal do not send to main.

13.6.2 TO SEND FX

Use this option to customize which of the 16 tracks, 2 effects (Delay, Chorus), and inputs that will send audio to the effects. Use **[UP]/[DOWN]** to switch between the setup pages. Use the **[TRIG]** keys to activate/deactivate the tracks, effects, and inputs that can send to FX. Green keys signal send to FX. Unlit keys signal do not send to FX.

13.6.3 USB IN

Sets where the incoming audio from the class compliant device is routed to in the Digitone II's signal path. This parameter is only available when **USB CONFIG** is set to USB AUDIO/MIDI. For more information, please see "13.8.1 USB CONFIG" on page 77.

MAIN The incoming audio is routed to the Digitone II's main outputs.

OFF No sound is routed from USB to the Digitone II.

13.6.4 USB OUT

Sets from where in the Digitone II's signal path, the outgoing audio is routed to the class compliant device. This parameter is only available when **USB CONFIG** is set to USB AUDIO/MIDI. For more information, please see "13.8.1 USB CONFIG" on page 77.

MAIN The outgoing audio is routed from the Digitone II's Main out at the end of the signal path.

L:T1-16/R:T1-16 The outgoing audio is routed from the selected track(s) Press a **[TRIG]** key twice to select a single track as a stereo source. The selected track's **[TRIG]** key lights up white.

Press first one **[TRIG]** key and then another to select two separate tracks as sources. The selected tracks' **[TRIG]** keys lights up blue for left channel and red for right channel. The audio from each track is then summed to mono, routed out and sent separately on left and right channel.

EXT The outgoing audio is routed straight from the Digitone II's audio inputs IN L/R to the class compliant device.

OFF No audio is sent to the class compliant device.

13.6.5 INT TO MAIN

Sets if Digitone II sends internal audio to the MAIN OUT and HEADPHONES OUT or not when used with a class compliant audio device.

OFF No sound is sent to main out.

ON Sound is always sent to main out.

13.6.6 USB TO MAIN [dB]

Sets the amount of amplification of the sound that is streamed over USB to the Digitone II main out when used with a class compliant audio device. (0 dB-+18 dB)

13.6.7 PRE/POST FADER

Sets if audio over USB should be pre or post the track level setting.



Audio from the **TRACK OUTPUTS** is always without any effects.

13.7 PERSONALIZE

Here you can customize a number of settings to fit you personal preferences.



13.7.1 LED INTENSITY

Sets the brightness of the key LEDs and screen. Use the **[LEFT]/[RIGHT]** keys to change the setting (LOW, MID, MAX).

13.7.2 LED BACKLIGHT

Switches the key LEDs backlight on/off.



Press and hold [SETTINGS] for a second and then press [TRIG 1–3] to set the intensity of the key LEDs and screen. Press and hold [SETTINGS] for a second and then press [TRIG 9] to toggle the key LEDs backlight on/off.

13.7.3 REMEMBER SUBPAGE

Will, when selected, remember which PARAMETER page's subpage you last used and access this page again the next time you press the same [PARAMETER] key. Use the [YES] key to toggle this setting. (ON, OFF).

13.7.4 U/D KEY MODE

Sets the functionality of the [UP]/[DOWN] keys. When set to KB OCT and you are in KEYBOARD mode, the keys shift keyboard octave up/down. When you are not in KEYBOARD mode, then keys navigates between parameter group pages. When set to NAV, the keys only navigate between parameter pages.

13.7.5 PAGE AUTOCOPY

Will, when set to on, automatically copy already placed trigs when extending the length of a pattern. If a pattern consists of for example two pages and the pattern length is increased to four pages, the two additional pattern pages are then copies of the first two pattern pages. For more information, please see "10.11 PAGE SETUP MENU" on page 46.

13.7.6 NOTE PARAM

Sets the interaction behavior for the NOTE parameter on the TRIG PARAMETERS page.

CHRO: Turning *DATA ENTRY* knob *A* changes the parameter in chromatic steps. Pressing and turning *DATA ENTRY* knob *A* changes the parameter in steps that follows the set scale.

SCALE: Turning *DATA ENTRY* knob *A* changes the parameter in steps that follows the set scale. Pressing and turning *DATA ENTRY* knob *A* changes the parameter in chromatic steps.

For more information, please see "8.5.2 KEYBOARD SETUP MENU" on page 24 and "11.2 TRIG PAGE 1" on page 55.

13.8 SYSTEM

The System menu contains a number of system related settings for the Digitone II.



13.8.1 USB CONFIG

Here you find settings related to USB audio and MIDI. Selecting one mode disables the other two modes.



USB MIDI select this option if you wish to send and receive MIDI over USB.

USB AUDIO/MIDI sets the Digitone II to send and receive audio and MIDI over USB. Select this option if you want to use the Digitone II together with a class compliant USB audio host.

13.8.2 OS UPGRADE

Use this menu option when you want to upgrade the Digitone II OS. To send the OS file, use our free Elektron Transfer software. Elektron Transfer can be downloaded from the Elektron website.

The device sending the OS file must be connected to the USB port of Digitone II.

Please note that the Digitone II will not appear as an icon on your computer desktop.

1. Download the Digitone II OS file from the Elektron website.
2. Connect the Elektron device to the computer via USB.
3. Open the Transfer application on your computer.
4. On the Transfer CONNECTIONS page, set the MIDI IN and MIDI OUT ports to your Elektron device.
5. On the Transfer DROP page, drag and drop the OS file. The OS file is then automatically transferred to the Elektron device and the OS update initiates. A progress bar is visible on device screen when receiving the OS.
6. On your device. Press **[YES]** to confirm the OS update.

When the update is done, the Digitone II will reboot.

13.8.3 FORMAT +DRIVE

You have the possibility to erase all content of the +Drive. Once you have made your choice using the **[LEFT]/[RIGHT]** keys and confirmed by pressing **[YES]**, a prompt will appear asking if you want to execute the formatting procedure. Press **[YES]** to proceed with the formatting.



PROJ+PST+KIT Erases all projects, presets, and kits.

13.8.4 MASTER TUNE

Sets the master tune for the whole device. Use **[LEFT]/[RIGHT]** to edit the value.

14. STARTUP MENU

To access this menu, hold down the **[FUNC]** key while powering up the Digitone II. From here you can perform a variety of tasks. To choose the different alternatives, press the corresponding **[TRIG]** key.

14.1 TEST MODE

To enter this mode, press the **[TRIG 1]** key.



For testing purposes, a short sound is heard through all outputs of the unit.

If you have any trouble with your Digitone II and suspect it may be due to a hardware problem, perform this self-test. The **[UP]** and **[DOWN]** keys can be used to scroll through the test log. A fully functional device should not report any errors. If it does report an error, please contact Elektron support or the retailer where you bought your Digitone II from.

14.2 EMPTY RESET

To perform this operation, press the **[TRIG 2]** key. All patterns and presets will be erased. The data on the +Drive remains intact.

14.3 FACTORY RESET

When performing a factory reset on the Digitone II, it will overwrite and re-initialize the active RAM project (including all pattern and global data). The +Drive project slot 1 will be overwritten and re-initialized with factory preset patterns, presets and settings. Preset bank A and B will be overwritten with the factory presets.

If you wish to keep the active project, remember to save it to a +Drive project slot higher than 1 before you perform a factory reset. To perform a factory reset, press the **[TRIG 3]** key.

14.4 OS UPGRADE

Use this menu option if you for some reason can't upgrade the Digitone II OS using the standard procedure in the SYSTEM menu. To send the OS file, use our free Elektron Transfer software. The Elektron Transfer can be downloaded from the Elektron website.

1. Download the Digitone II OS file from the Elektron website.
2. Connect the Digitone II's MIDI IN port to the MIDI OUT port of the computer's MIDI interface.
3. Hold down the **[FUNC]** key while powering on Digitone II. This takes you to the STARTUP menu.
4. Press the **[TRIG 4]** key to enter OS UPGRADE mode.
5. Open the Transfer application on your computer. On the Transfer CONNECTION page, click "go to the SYSEX TRANSFER page".
6. On the SYSEX TRANSFER page, click "OS Upgrade via device startup menu", and then follow the on-screen instructions.

When the update is done, the Digitone II will reboot.



USB MIDI transfer is not possible when upgrading the OS from the STARTUP menu.

14.5 EXIT

Press the **[TRIG 5]** key to exit the STARTUP menu.

15. SETUP EXAMPLES

The Digitone II likes to play with other machines. Whether it uses its ability to sync and play with legacy machines or controls other synthesizers: Digitone II gets along with other gear.

15.1 DIGITONE II WITH A MONOPHONIC BASS MACHINE

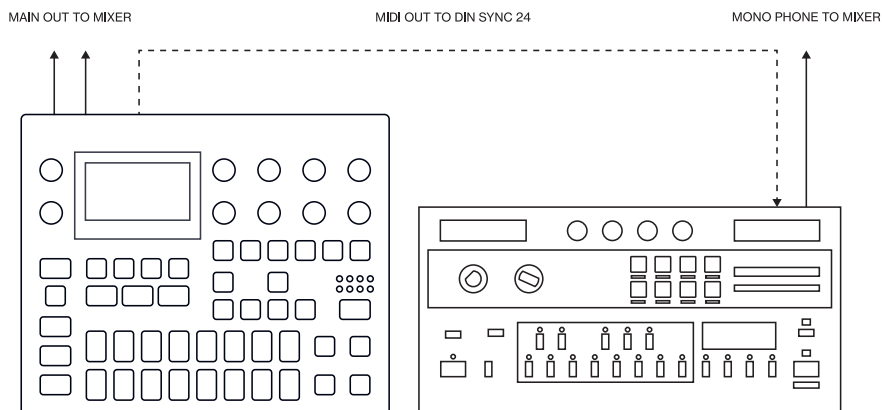

The DIN sync capabilities of the Digitone II allows you to use gear from yesteryear.

In this example, a legacy monophonic bass machine is used alongside the Digitone II. The Digitone II can stop, start and control the tempo of the bass machine.

1. Prepare a bassline pattern on the bass machine.
2. Connect the output of the bass machine to the mixer using a Mono jack 6.3 mm male cable.
3. Connect the Digitone II audio outputs to the mixer using 2 x Mono or Stereo jack 6.3 mm male cables.
4. Use a DIN connector cable to connect the MIDI OUT of the Digitone II to the SYNC IN of the bass machine.
5. On the Digitone II, press [SETTINGS], and then navigate to MIDI CONFIG > PORT CONFIG and set **OUT PORT CONFIG** to DIN24.

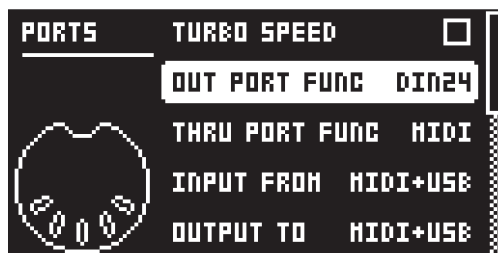

6. Press [PLAY] on the Digitone II.

15.3 CONTROLLING A SYNTHESIZER USING THE MIDI TRACKS

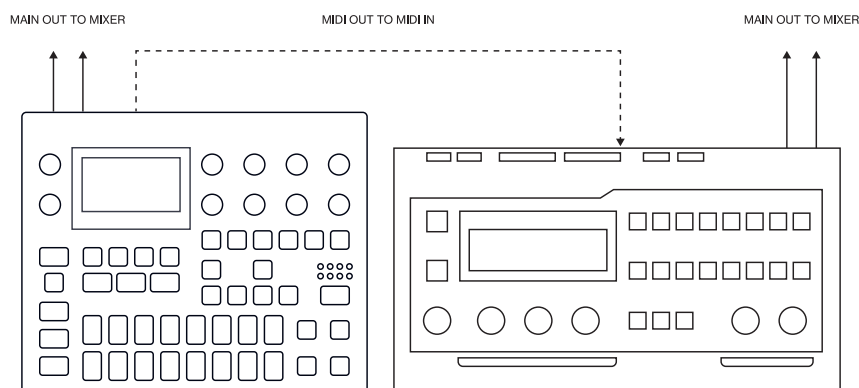

Digitone II has extensive capabilities to use its sequencer's MIDI tracks to control other MIDI-equipped synthesizers.

1. Use a standard MIDI cable to connect the Digitone II MIDI OUT jack with the synthesizer's MIDI IN jack.
2. On the Digitone II, press **[SETTINGS]**, and then navigate to MIDI CONFIG > PORT CONFIG and set **OUT PORT FUNC** to MIDI.
3. In the same menu set **OUTPUT** to MIDI.



4. On the main screen, press **[TRK]** + **[TRIG 1-16]** to select a track that uses a MIDI SYN machine.
5. Press **[SYN]** and use the **CHAN** parameter to select a MIDI channel that the track will output its data to.
6. Make sure to set your synthesizer to receive MIDI input in a way that corresponds to the settings you made in the Digitone II.

You are now ready to use the Digitone II sequencer to control your synthesizer. For more information about using the Digitone II sequencer, please see "10. THE SEQUENCER" on page 39.

16. KEY COMBINATIONS

Use the key combinations below to quickly perform certain tasks.

COPY/PASTE/CLEAR

TRACK SEQUENCE (ALL TRIGS ON THE TRACK)

When in GRID RECORDING mode.

[FUNC] + [RECORD] to copy the active track's sequence.

[FUNC] + [STOP] to paste the copied track's sequence to the active track.

[FUNC] + [PLAY] to clear the active track's sequence.

TRIG

When in GRID RECORDING mode

[TRIG] + [RECORD] to copy the trig with it's parameter locks.

[TRIG] + [STOP] to paste the copied trig.

[TRIG] + [PLAY] to clear the trig.

PATTERN

[FUNC] + [RECORD] to copy the active pattern.

[FUNC] + [STOP] to paste the copied pattern to the active pattern.

[FUNC] + [PLAY] to clear the active pattern.

PRESET

[TRK] + [RECORD] to copy the selected track's preset.

[TRK] + [STOP] to paste the copied preset to the selected track.

[TRK] + [PLAY] to clear the selected track's preset.

SEQUENCER PAGE

When in GRID RECORDING mode

[PAGE] + [RECORD] to copy the active page.

[PAGE] + [STOP] to paste the copied page to the active page.

[PAGE] + [PLAY] to clear the active page.

TRACK/PATTERN/BANK SELECT

[TRK] + [TRIG 1-16] keys to select a track.

[FUNC] + [PTN] + [TRIG 1-16] to choose a pattern bank

[PTN] and [LEFT]/[RIGHT] and [TRIG 1-16] keys to select a bank/pattern.

NAMING

[FUNC] + [ARROW] (on the NAMING screen) to choose a letter.

[FUNC] + [NO] (on the NAMING screen) to erase a letter.

[FUNC] + [YES] (on the NAMING screen) to add a blank space.

SAVING AND RELOADING

PATTERN

[FUNC] + [NO] to reload the active pattern.

[FUNC] + [YES] to temporarily save the active pattern.

PRESET

When in GRID RECORDING mode.

[TRIG] + [PRESET/KIT] save the sound of a trig as a preset, taking all parameter locks in consideration.

[TRIG] + [YES] previews the trig.

[FUNC] + [SETTINGS] saves the active project.

[FUNC] + [YES] temporary saves the active pattern.

[FUNC] + [NO] temporary reloads the active pattern.

[PARAMETER] key + [NO] reloads all parameters on that parameter page from its last saved state

[PARAMETER] key + [YES] randomizes parameters on that parameter page

[TRK] + [TRIG1-16] + [NO] reloads the preset from its last saved state

MENU ACCESS

[FUNC] + [SONG] opens the SONG EDIT menu.

[FUNC] + [TRIG PARAMETERS] opens the QUANTIZE menu.

[FUNC] + [SYN] opens the MACHINE menu.

[FUNC] + [FLTR] opens the SETUP menu.

[FUNC] + [AMP] opens the SEQUENCER menu.

[FUNC] + [FX] opens the SEND FX pages.

[FUNC] + [MOD] opens the MIXER pages.

[FUNC] + [PAGE] opens the pattern/track PAGE SETUP menu.

[FUNC] + [KEYBOARD] opens the keyboard setup menu.

SEQUENCER SETTINGS

[FUNC] + [TEMPO] to tap tempo.

[LEFT/RIGHT] to nudge tempo (when sequencer is playing).

[FUNC] + [LEFT/RIGHT] moves all trigs a whole step, left or right (when in GRID RECORDING mode).

[TRIG] key (hold) + [LEFT/RIGHT], opens the MICRO TIMING menu and sets the micro timing for the trig (when in GRID RECORDING mode).

[FUNC] + [UP]/[DOWN] (In the PAGE SETUP menu) sets the TRACK LENGTH in musical increments from 2/16 to 64/64.

SEQUENCER RECORDING

[RECORD] + [PLAY] starts LIVE RECORDING.

[RECORD] + [STOP] activates STEP RECORDING.

[RECORD] + double-press [PLAY] activates/deactivates QUANTIZE LIVE RECORDING.

Hold [PAGE] and press [LEFT]/[RIGHT] to change sequencer page, or hold [PAGE] and press one of the lit [TRIGS] to jump to that page (when in GRID RECORDING mode).

MUTES

[FUNC] + [TRIG] keys mutes/unmutes one or several tracks.

When in MUTE mode, press and hold [FUNC] + [TRIG] keys to prepare the track to be muted/unmuted. Releasing [FUNC] will perform the action.

MODES

[FUNC] + [TRK] enters GLOBAL MUTE mode.

[FUNC] + double-press [TRK] enters PATTERN MUTE mode.

[KEYBOARD] enters/exits KEYBOARD mode.

[FUNC] + [UP]/[DOWN] accesses the TRIG mode menu

[YES] + [PAGE] activates FILL mode for one pattern cycle. Pressing [PAGE] again deactivates FILL mode.

When not in GRID RECORDING mode, press and hold [PAGE] to activate FILL Mode for as long as [PAGE] is held.

Press and hold [PAGE] + [YES], and then release [PAGE] before you release [YES] to latch FILL mode.

Press [PAGE] again to unlatch FILL mode.

RESET PARAMETERS

Press *DATA ENTRY* knob + **[NO]** to reset the parameter to the default value.

[PARAMETER] key + **[PLAY]** to reset all the parameters in the selected parameter page to default values.

PRESET/TRIG PREVIEW

[FUNC] + **[YES]** (In the PRESET BROWSER/PRESET MANAGER) previews the highlighted preset.

[TRIG] + **[YES]** (In GRID- and STEP RECORDING mode) previews the selected trig.

SONG MODE

[SONG] + **[TRIG 1-16]** to select song and enter SONG mode.

[FUNC] + **[SONG]** to open the SONG EDIT screen.

[SONG] + **[LEFT]** (when in SONG mode) to loop the currently playing row. Press **[SONG]** + **[LEFT]** again to stop looping the row and return to normal song playback.

[SONG] + **[UP]** (when in SONG mode) to move the song pointer up one row.

[SONG] + **[DOWN]** (when in SONG mode) to move the song pointer down one row.

Press **[SONG]** (when in SONG mode) twice to open the SONG EDIT screen.

[FUNC] + **[RECORD]** (when in the SONG EDIT screen) copies the selected row.

[FUNC] + **[STOP]** (when in the SONG EDIT screen) pastes a previously copied row to the selected row.

[FUNC] + **[PLAY]** (when in the SONG EDIT screen) resets the selected row to the pattern's default BPM, length, and mute state.

[FUNC] + **[DOWN]** (when in the SONG EDIT screen) adds a new row.

[FUNC] + **[UP]** (when in the SONG EDIT screen) deletes the selected row.

TRANPOSE

[FUNC] + **[+]/[-]** to transpose the current track up/down in semitones.

[TRK] + **[+]/[-]** to transpose the current track up/down in semitones.

[TRK] + **[FUNC]** + **[+]/[-]** to transpose the current track in octaves (+-12 semitones).

[PTN] + **[+]/[-]** to transpose the pattern up/down in semitones.

[PTN] + **[FUNC]** + **[+]/[-]** to transpose the pattern up/down in octaves (+-12 semitones).

When in GRID RECORDING mode **[TRIG]** + **[+]/[-]** to transpose the current trig in semitones (destructively).

NOTE EDIT

[FUNC] + **[LEFT]/[RIGHT]** to go to the previous/next sequencer step that contains a note trig.

[LEFT]/[RIGHT] to go the previous/next sequencer step regardless if it contains a trig or not.

[FUNC] + **[UP]** to delete the highlighted note.

[FUNC] + **[DOWN]** to add a note below the highlighted note.

[FUNC] + **[YES]** to preview the selected step.

[FUNC] + **[PAGE]** to navigate to the next pattern page.

When in GRID RECORDING mode **[TRIG]** + **[NOTE EDIT]** to jump to that trig in Note Edit.

TRACK

[FUNC] + **[VOICE]** to toggle the current track's unison mode on/off.

[FUNC] + **[ARP]** to toggle the current track's arpeggiator on/off.

17. TECHNICAL INFORMATION

ELECTRICAL SPECIFICATIONS

Impedance balanced audio outputs

Main outputs level: +18 dBu peak

Output impedance: 440 Ω unbalanced

Headphones output

Headphones out level: +18 dBu peak

Output impedance: 36 Ω

Audio inputs

Input level: +18 dBu peak

Audio input impedance: 21 k Ω

Unit power consumption: 7 W typical

Recommended power supply: PSU-3c (12 V DC, 2A)

HARDWARE

128 \times 64 pixel OLED screen

MIDI In/Out/Thru with DIN Sync out

2 \times 1/4" impedance balanced audio out jacks

2 \times 1/4" balanced audio in jacks

1 \times 1/4" stereo headphone jack

48 kHz, 24-bit D/A and A/D converters

Hi-speed USB 2.0 port

Power inlet: Center positive 5.5 \times 2.5 mm barrel jack,

12 V DC, 1 A

PHYSICAL SPECIFICATIONS

Sturdy steel casing

Dimensions: W 215 \times D 176 \times H 63 mm

(8.5" \times 6.9" \times 2.5") (including knobs and feet)

Weight: approximately 1.48 kg (3.25 lbs)

100 \times 100 mm VESA mounting holes. Use M4 screws with a max length of 7 mm.

Maximum recommended ambient operating

temperature: +40 $^{\circ}$ C (+104 $^{\circ}$ F)

18. CREDITS AND CONTACT INFORMATION

CREDITS

ELEKTRON CREW

Lennart Ahlstedt
Johannes Algelind
Magnus Almberg
Christian Alsing
Hans Alvarsson
Deva Andar
Nikolaj Andersson
Madeleine Antonsson
Anyere Bendrien
Andreas Brykt
Chloe Corley
Johan Damerau
Oscar Dragén
Magnus Forsell
Jennifer Giöbel
Birgitta Hedström
Mario Adriane Hernandez
Tomas Hjalmarsson
Thomas Jansson
Patrik Johansson
Christian Karlsson
George Kaplan
Åsa Larsson
Erik Liakhovets
Christer Lindström
Joel Lundberg
Johannes Mai
Enrique Martinez
Jimmy Myhrman
Viktor Nilsson
Jean Michel Pepin
Mattias Rickardsson
Patrik Rinvall
Viktor Sandström
Matthias Tellen
David Smallbone Tizard
Che Thomas
Jake Widgeon
Vladislav Zhukov
Erik Ångman

FACTORY LIBRARY CONTENT

Factory Presets

Michael Feiner
Jogging House
Chad Mossholder
Aho Ssan
The Elektron Crew

Factory Patterns

Jeremiah Chiu
Lying Dalai
Ash Farrand aka Hissquiet
Michael Feiner
Jogging House
Gareth Mallinson
The Elektron Crew

BETA TESTING

To our amazing beta testers – you know who you are; this product is better because of you!

CONTACT INFORMATION

ELEKTRON WEBSITE

<https://www.elektron.se>

OFFICE ADDRESS

Elektron Music Machines MAV AB
Banehagsliden 5
SE-414 51 Gothenburg
Sweden

APPENDIX A: MACHINES

A machine is a module within the Digitone II with specific functionality. A machine can be switched out for another machine in the same category. For example different synthesis engines or filters. Every machine has a specific set of parameters tailored to give you the most relevant and useful sound-shaping possibilities for that particular machine. For more information, please see “5.3.1 AUDIO TRACKS AND MACHINES” on page 16

Use the [UP]/[DOWN] keys to select the parameter group's pages. You can also press a [PARAMETER] key repeatedly to cycle through the parameter pages in that group. Press and hold a [PARAMETER] key to see the values for all parameters on that page.

A.1 ASSIGNING MACHINES TO THE ACTIVE TRACK

1. Press [FUNC] + [SYN] to open the MACHINE menu.
2. Use [LEFT]/[RIGHT] to navigate to the desired machine category.
3. Use [UP]/[DOWN] to select machine, and then press [YES] to assign the selected machine to the track.

The rest of this appendix lists the machine-specific parameters on the SYN and FLTR pages. The selected machine determines the parameters available.

A.2 SYN MACHINES

The SYN machines are different synthesis engines with unique functionalities. In this section you also find the MIDI machine that lets you control external, MIDI equipped, gear. For more information, please see “5.3.2 MIDI TRACKS” on page 17. You can assign any SYN machine to any track. Press [SYN] to access these parameter pages.



A.2.1 FM TONE

The Digitone II's FM TONE machine is a four operator Frequency Modulation (FM) synth in the style of the classic 80s implementations. However, unlike the early FM synths, the Digitone II use its FM engine more like a complex tone generator than a complete synthesizer voice (although it does have this capability too). The Digitone II signal path is more similar to a typical subtractive synth than a classic FM voice.

PAGE 1

The parameters on the page 1 control various aspects of the FM engine. You can find more information about the Digitone II FM synthesis in “APPENDIX B: THE FM TONE SYNTHESIS” on page 105.



ALGO

Algorithm selects the structure of how the four operators are connected to each other. For more information, please see “B.3 ALGORITHMS” on page 106.

RATIO C

Sets the frequency ratio for operator C. For more information, please see “B.4 FM RATIOS” on page 106.

RATIO A

Sets the frequency ratio for operator A. For more information, please see “B.4 FM RATIOS” on page 106.

RATIO B

Sets the frequency ratio for operator B1 and B2. The minimum value for B1 and B2 is .25. As you turn the encoder, B2 increases until it reaches the max (16). It then starts over from .25 and B1 increases to the next value (0.5). This revolving behavior continues until both operators reach the maximum value. This parameter behavior is similar to the movement of the hands on a watch. (0.25–16.0) For more information, please see “B.4 FM RATIOS” on page 106.

HARM

Harmonics controls waveform of the operators, C, A, and B1. The parameter is bipolar. Negative parameter values change the harmonics of operator C, while positive parameter values change the harmonics of operators A and B1. (-26.00–26.00) For more information, please see “B.6 HARMONICS” on page 108.

DTUN

Detune offsets the ratio of operator A and B2. Up to a parameter value of around 64, the offset is very slight to achieve subtle movement. Above 64 the operators start to detune more heavily.

FDBK

Feedback sets the amount of self modulation of the operator that has feedback. This operator is shown in the algorithm on the screen with a feedback loop in its upper left corner. For more information, please see “B.2 OPERATORS” on page 105.

MIX

Each algorithm has two carrier outputs (X and Y) that come from two different operators depending on what algorithm you chose. Use the MIX parameter to mix between these outputs so that you can cross-fade between two separate timbres. (-64–63). For more information, please see For more information, please see “B.3 ALGORITHMS” on page 106.

PAGE 2

The parameters on the page 2 control various aspects of the FM synthesis, mainly the amount of frequency modulation together with the operator envelopes.

The FM engine has two operator envelopes. One is for operator group A, and one is for group B (B1 and B2). The envelopes are essentially expanded AD (Attack Decay) envelopes, but with an added adjustable end level (the amplitude level the sound reaches at the end of the decay stage). For more information, please see “B.5 OPERATOR ENVELOPES” on page 107.

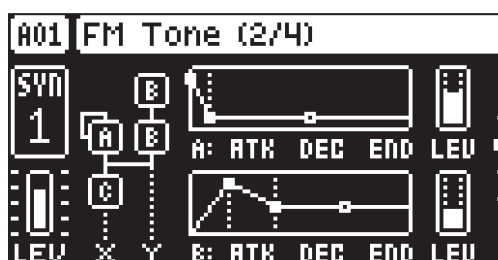
**ATK (A)**

Attack Time sets the length of the attack phase of the modulation envelope for operator A.

DEC (A)

Decay Time sets the length of the decay phase of the modulation envelope for operator A.

END (A)

End Level sets the end level of the modulation envelope for operator A.

LEV (A)

Level sets the modulation amount from operator A.

ATK (B)

Attack Time sets the length of the attack phase of the modulation envelope for operator group B (B1 and B2).

DEC (B)

Decay Time sets the length of the decay phase of the modulation envelope for operator group B (B1 and B2).

END (B)

End Level sets the end level of the modulation envelope for operator group B (B1 and B2).

LEV (B)

Level sets the modulation amount from operator group B (B1 and B2).

The **LEVEL** parameter for B is macro mapped to both operator B1 and B2 and control their modulation amount as per this graph:

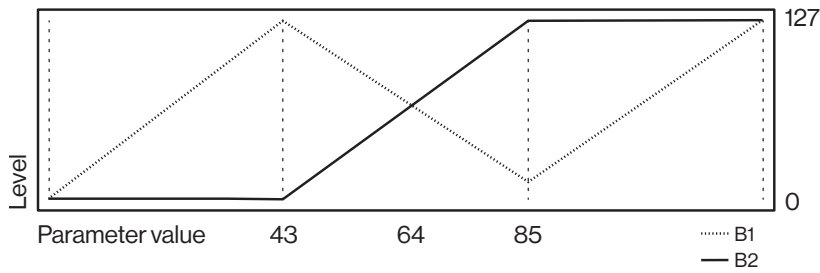

If you wish to use frequency modulation, it is important that you turn the LEV parameters up, since they set the amount of frequency modulation in the FM engine.

PAGE 3

The parameters on the page 3 control various aspects of the FM synthesis, mainly the amount of frequency modulation together with the operator envelopes and their behavior.

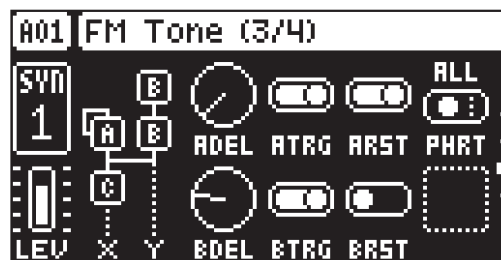

ADEL

Envelope delay sets the time before attack phase of the modulation envelope for operator A starts.

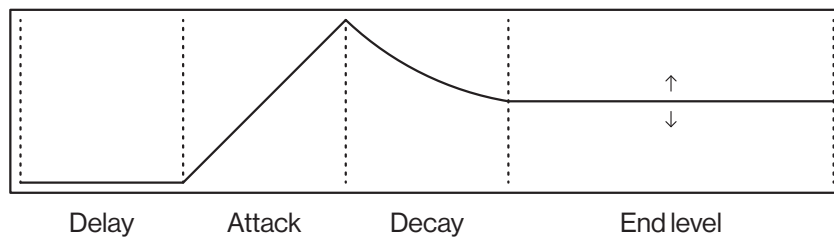

ATRG

Envelope trig sets the trig behavior of the operator envelopes. The envelopes can be either triggered or gated - making it either an ADE (Attack Decay End) or an ASDE (Attack Sustain Decay End) envelope. The sustain phase does not have an adjustable envelope level. It is instead the **LEV** parameter that sets the sustain level. The note length defines the length of the sustain phase.

Triggered (ATRГ/BTRГ ON)

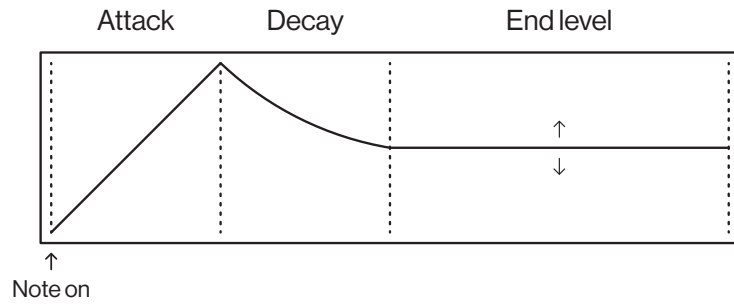

Gated (ATRГ/BTRГ OFF)

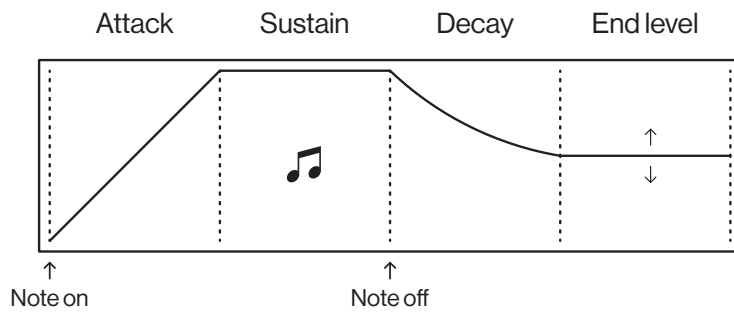

ARST

Envelope reset sets if the envelopes should reset or not when they are retriggered.

Reset on (ARST/BRST ON)

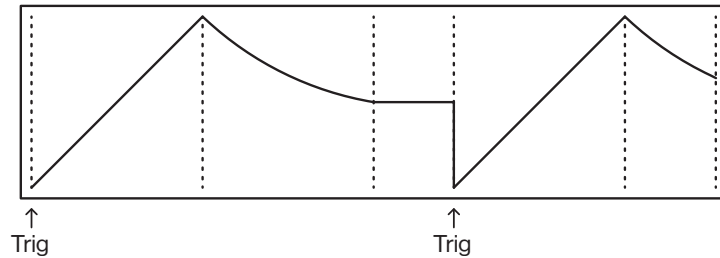

Reset off (ARST/BRST OFF)

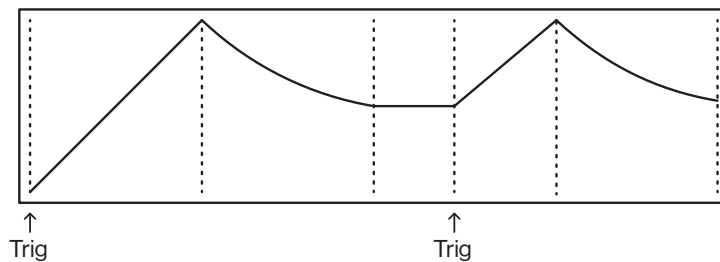

PHRT

Phase reset sets if the operators phase are reset to start at 0 or not when they are triggered.

OFF do not reset any operators

ALL resets all operators

C resets operator C

A+B resets operator A, B1, and B2

A+B2 resets operator A and B2

BDEL

Same as ADEL but for operator group B (B1 and B2).

BTRG

Same as ATRG but for operator group B (B1 and B2).

BRST

Same as ARST but for operator group B (B1 and B2).

PAGE 4

The parameters on the page 4 controls the operators ratio offsets and the key scaling.

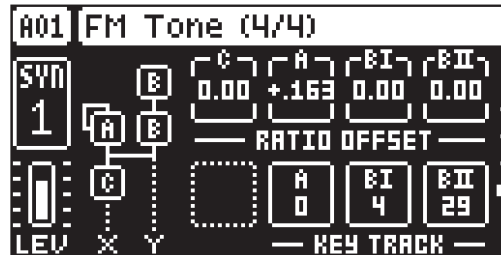

RATIO OFFSET C, A, B1, B2

Adds offsets to the ratios of each of the four operators.

KEY TRACK A

Key track sets the level of how much the modulation output from operator A is affected by what note you play on the keyboard. If you set key track to 0, the modulation level is the same for all keys. A higher setting decreases the modulation level more and more the higher you play the keyboard. So, a lower level of modulation decreases the complexity of the tone in the higher frequencies, which is a typical behavior in many acoustic instruments.

KEY TRACK B1

Same as KEY TRACK A, but for operator B1.

KEY TRACK B2

Same as KEY TRACK A, but for operator B2.

A.2.2 FM DRUM

The Digitone II's FM DRUM machine is an FM engine specially tailored to produce drums and other percussive sounds, although it also works well for melodic sounds. Below, you see the FM DRUM machine's voice architecture.

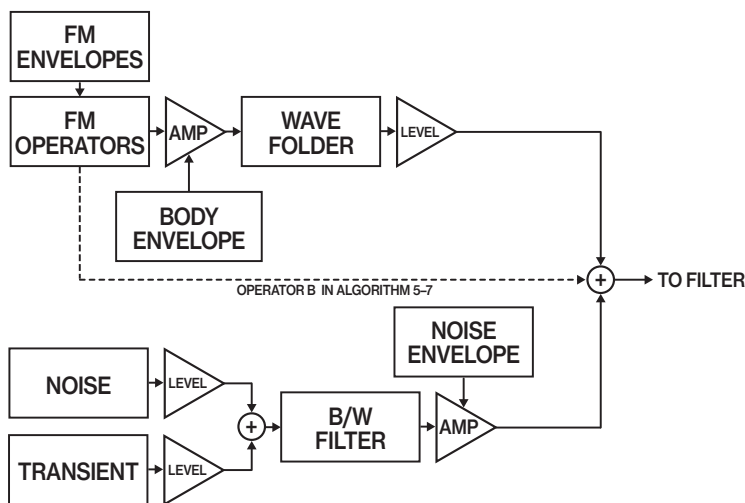

PAGE 1



TUNE

Tune sets the pitch of the oscillator.

STIM

Sweep Time sets the pitch sweep time. Lower values result in shorter sweep.

SDEP

Sweep Depth sets the depth of the pitch sweep.

ALGO

Algorithm selects the structure of how the four operators are connected to each other.

OP.C

Operator C Wave sets the waveform for Operator C.

OP.AB

Operator AB Wave sets the waveform for Operators A and B.

FDBK

Feedback sets the amount of self modulation of the operator that has feedback. This operator is shown in the algorithm on the screen with a feedback loop in its upper right corner.

FOLD

Fold sets the amount of wavefolding of the body part of the sound. (The noise and transient parts of the sound are excluded.) The wavefolding increases the complexity of the wave and creates a more overtone rich sound.

PAGE 2

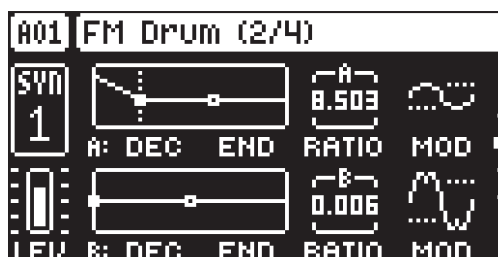

DEC

Decay A sets the length of the decay phase of the modulation envelope for operator A.

END

End A sets the end level of the modulation envelope for operator A.

RATIO

Ratio A sets the frequency ratio for operator A.

MOD

Mod A sets the modulation amount from operator A.

DEC

Decay B sets the length of the decay phase of the modulation envelope for operator B.

END

End B sets the end level of the modulation envelope for operator B.

RATIO

Ratio B sets the frequency ratio for operator B.

MOD

Mod B sets the modulation amount from operator B.

PAGE 3

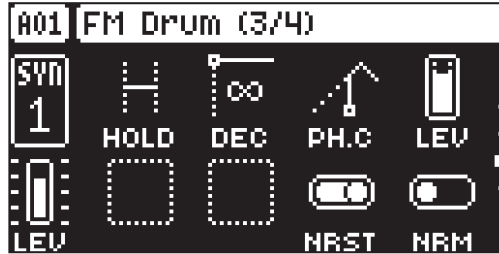

HOLD

Body Hold sets the time before the decay phase starts for the body part of the sound.

DEC

Body Decay sets the length of the decay phase for the body part of the sound. The last value is infinite.

PH.C

OP C Phase sets the reset of the phase for operator C. A parameter value less than 90 means that phase reset is on, and the value represents the phase start position in degrees. At 90, the operator resets at the peak of the waveform. When set to OFF (value 91), operator C's phase is not reset.

LEV

Body Level sets the level of the body part of the sound.

NRST

Noise Reset will (when switched on) reset the noise to the same random seed on every note on. This can be useful if you want the noise part to always sound the same, like if it was a sample.

NRM

Noise Ring Mod will (when switched on) use Operator C as ring modulator for the noise.

PAGE 4



NHLD

Noise Hold sets the time before the decay phase starts for the noise part of the sound.

NDEC

Noise Decay sets the length of the decay phase for the noise part of the sound. The last value is infinite.

TRAN

Drum Transient selects between different transients.

TLEV

Transient Level sets the level of the transient part of the sound.

BASE

Noise Base sets the base frequency for the noise/transient filter.

WDTH

Noise Width sets the frequency width above the base frequency for the noise/transient filter.

GRAN

Noise grain adjusts the density of the grains for the noise part of the sound, from high density (white noise) to low (grainy).

NLEV

Noise Level sets the level of the noise part of the sound.

A.2.3 WAVETONE

The WAVETONE machine is a two-oscillator synth engine with very flexible wave shaping possibilities, borrowing elements from phase distortion, wavetables, ring modulation, hard sync, and adding flexible noise design.

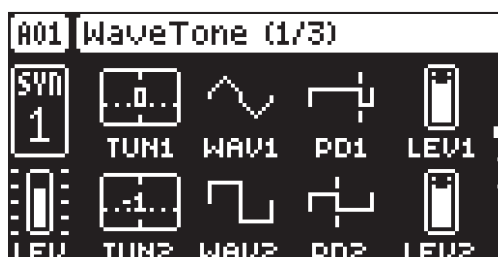
PAGE 1**TUN1**

Osc1 Tune sets the pitch of oscillator 1.

WAV1

OSC1 Waveform sets the waveform for oscillator 1. The waveform crossfades between the different waveforms. Which waveforms you can select here depends on what wavetable you select with TBL1.

PD1

Osc1 Phase Distortion controls the amount of phase distortion of oscillator 1. Think of it as changing the pulse width, but on any waveform, not just square waves.

LEV1

Osc1 Level sets the level of oscillator 1.

TUN2

Osc2 Tune sets the pitch of oscillator 1.

WAV2

Osc2 Waveform sets the waveform for oscillator 2. The waveform crossfades between the different waveforms. Which waveforms you can select here depends on what wavetable you select with TBL2.

PD2

Osc2 Phase Distortion controls the amount of phase distortion of oscillator 2. Think of it as changing the pulse width, but on any waveform, not just square waves.

LEV2

Osc2 Level sets the level of oscillator 2.

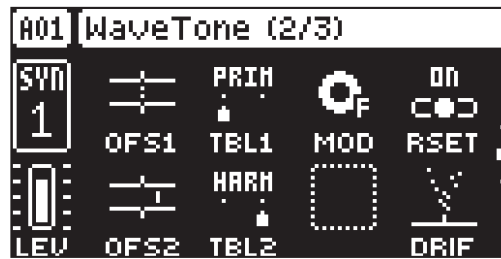

Phase distortion makes the oscillator traverse the first and second half of the waveform at different speeds, effectively distorting the waveshape by dragging its midpoint towards the start or end. A simple example is the squarewave, where phase distortion acts a pulsewidth parameter adjusting the duty cycle of the waveform.

**OFS1**

Osc1 Lin Offset sets an offset of oscillator 1 tuning. This parameter offsets the frequency of the oscillator linearly in hertz (unlike **TUNE** which adjusts the pitch in cents). This feature gives more noticeable detune in lower notes than higher. It allows for a different kind of chorus-like detune, since the beating frequency does not vary with the pitch.

TBL1

Osc1 Wavetable selects the wavetable for the oscillator 1 **WAVE** parameter. PRIM contains the basic oscillator waves Sin, Tri, Saw, Square. HARM contains a long list of waveforms sweeping across other combinations of harmonics.

MOD

Oscillator Modulation selects different ways the two oscillators can interact with each other. The settings are OFF, RING MOD, RING MODE FIXED (Osc 2 does not track note values), and HARD SYNC.



In RING MOD mode, Oscillator 2 is modulating Oscillator 1. In that configuration, you most often don't want to hear the modulator, so you would turn down LEV2 to 0. TUN1 will adjust the tuning of the sound, while TUN2 will change the sound. Even if LEV2 is set to 0, adjusting WAV2 and PD2 will impact the timbre of the sound.

In HARD SYNC mode, Oscillator 1's phase is reset every time Oscillator 2's waveform starts a new cycle. In this mode, TUN2 controls the tuning of the sound, and TUN1 will control another aspect of the sound, that may sound a bit like a filter with resonance when modulated.

RSET

Oscillator Phase Reset sets if and how the oscillator's wave phase resets when you play a note. OFF does not reset the oscillator phase. ON resets the oscillators to the start of their waveform phase. RAND resets the oscillators to a random position in the waveform phase.

OFS2

Osc2 Lin Offset sets an offset of oscillator 2 tune. This parameter offsets the frequency of the oscillator linearly in hertz (unlike **TUNE** which adjusts the pitch in cents). This feature gives more noticeable detune in lower notes than higher. It allows for a different kind of chorus-like detune, since the beating frequency does not vary with the pitch.

TBL2

Osc2 Wavetable selects the wavetable for the oscillator 2 **WAVE** parameter. PRIM contains the basic oscillator waves Sin, Tri, Saw, Square. HARM contains a long list of waveforms sweeping across other combinations of harmonics.

DRIF

Oscillator Drift sets the amount of random pitch drift of oscillator 1 and 2.

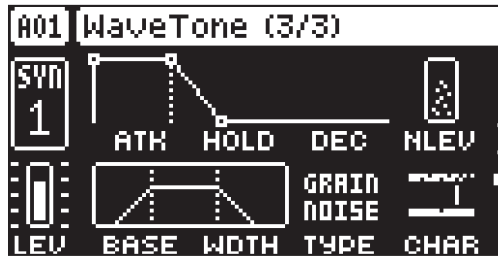

ATK

Noise Attack sets the length of the attack phase of the noise amp envelope.

HOLD

Noise Hold sets the length of the hold phase of the noise amp envelope. Fixed Hold time values (0-126) specify the length of the hold phase, and the envelope ignores Note Off events such as Trig Length, releasing a [TRIG] key or a key on an external controller. Setting **HOLD** to NOTE means the hold phase will be determined by Note On and Note Off events.



If you set **HOLD** to **NOTE** and use an external keyboard to trigger the envelope, then the sound will be sustained (if **DEC** is set to less than 127) for as long as you press a key on the keyboard.

DEC

Noise Decay sets the length of the decay phase of the noise amp envelope.

NLEV

Noise Level sets the level of the noise part of the sound.

BASE

Noise Base sets the base frequency for the noise filter.

WIDTH

Noise Width sets the frequency width above the base frequency for the noise filter.

TYPE

Noise Type selects between three different types of noise, **GRAIN**, **TUNED** (a Sample and Hold that tracks the pitch, and **S&H** (Sample and Hold).

CHAR

Noise Character changes the character of the noise. The effect of this parameter vary depending on the selected **TYPE**.

GRAIN, Character sets the density of the grain, from white noise to very grainy.

TUNED, Character sets the base tuning of the sample & hold that are then tracked by pitch.

S&H, Character sets the fixed tuning of the sample and hold.

A.2.4 SWARMER

The **SWARMER** machine is based on using one main oscillator and a swarm of six additional detuned oscillators to create a rich sound.



TUNE

Tune offsets the incoming note value. This parameter is bipolar. A setting of 0 leaves the pitch unchanged.

SWRM

Swarm Waveform sets the waveform of the detuned swarm oscillators.

DET

Detune sets the amount of detuning of the six swarm oscillators in relation to the main oscillator.

MIX

Mix sets the level of the swarm oscillators in relation to the main oscillator.

M.OCT

Main Octave detunes the main oscillator down one or two octaves but leaves the swarm oscillators' pitch unchanged.

MAIN

Main Waveform sets the waveform of the main oscillator.

ANIM

Swarm Animation sets the modulation amount of the swarm oscillators. The swarm oscillators are modulated separately in pairs by hidden LFOs running at different rates.

N.MOD

Noise Modulation sets the amount of noise modulation of the detuned swarm oscillators.

A.2.5 MIDI

The parameters for the MIDI machine are split over the **TRIG**, **SYN**, **FLTR** and **AMP PARAMETER** pages. The **FX** page contains no parameters. The **MOD** pages are the same as for audio tracks, but there are two LFOs available for MIDI tracks.

TRIG PAGE 1

Set the actions for when a note is triggered. Change settings using the **DATA ENTRY** knobs. These general settings affect note trigs placed in the sequencer.

**NOTE**

Trig Note sets the pitch of the note when triggered. When in LIVE RECORDING mode and playing in KEYBOARD mode, the pitch of the **[TRIG]** keys played will override this setting. Press and turn **DATA ENTRY** knob **A** to select only note values that exist in the scale set by **KB SCALE**. For more information, please see "8.5.2 KEYBOARD SETUP MENU" on page 24.

VEL

Trig Velocity sets the velocity of the sequencer's note trigs.

LEN

Trig Length sets the length of the note trig. In LIVE RECORDING mode, the duration of pressing the **[TRIG]** keys overrides this general setting.

PROB

Trig Probability sets the probability that the trigs on the track plays or not. The probability outcome is re-evaluated every time a trig is set to play. The default setting is 100%, meaning that all the trigs on the track plays every time. This parameter can be parameter locked which lets you give separate trigs their own probability.

LFO.T

LFO Trig controls if the LFO will be triggered or not.

FILL

Fill is a separate trig condition that determines if a trig is active (plays) or not depending on if the device is in FILL mode or not. For more information, please see “10.12.4 FILL MODE” on page 50, and “10.12.3 TRIG CONDITIONS AND CONDITIONAL LOCKS” on page 49.

ON, A trig with **FILL** set to ON, plays when FILL mode is active.

OFF, A trig with **FILL** set to OFF plays when FILL mode is not active.



The sequencer needs to be in FILL mode to activate the FILL trig condition. For more information, please see “10.12.4 FILL MODE” on page 50.

COND

(Trig Condition) when you add a conditional lock, **COND** sets the Trig Condition with which a set of conditional rules can be applied to any trig, using a conditional parameter lock. For more information, please see “10.12.3 TRIG CONDITIONS AND CONDITIONAL LOCKS” on page 49.

SYN PAGE

Here you can set the MIDI channel that the MIDI machine should use to send data. Bank and program change values are also set here, together with a few standard CC parameters. The default value of the parameters on this page is OFF, meaning they are disabled and do not send out any data. Press and hold **[FUNC]** and then press the **DATA ENTRY** knobs to enable them. You can then use the **DATA ENTRY** knobs to set the parameter values as usual. Disable the parameters again by repeating the activation procedure.



CHAN (Channe) sets the MIDI channel the track sends MIDI data to. If you set this parameter to OFF, it turns the MIDI track off. Please note that this parameter cannot be parameter locked. (OFF, 1-16)

BANK (Bank) sends a bank change message on CC 0 MSB.

SBNK (Sub Bank) sends a bank change message on CC 32 LSB.

PROG (Program Change) sends a Program Change message.

PB (Pitch Bend) controls the pitch bend data sent on the MIDI track.

AT (Aftertouch) controls the aftertouch data sent on the MIDI track.

MW (Mod Wheel) controls the modulation wheel data sent on the MIDI track.

BC (Breath Controller) controls the breath control data sent on the MIDI track.

FLTR PAGE 1

Here you can set the values of the first eight assignable CC commands. The default value of the parameters on this page is OFF, meaning they are disabled and do not send out any data. Press and hold **[FUNC]** and then press the **DATA ENTRY** knobs to enable them. You can then use the **DATA ENTRY** knobs to set the parameter values as usual. Disable the parameters again by repeating the enabling procedure.

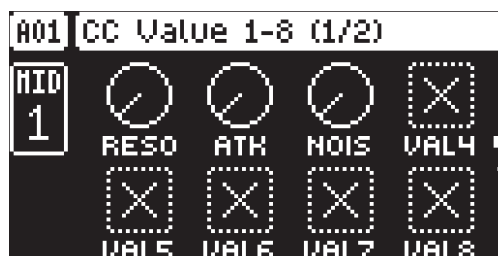

VAL1-VAL8 (CC 1–8 Value) controls the values that the CC commands send. You specify the CC commands themselves on FLTR page 2. These parameters default value is OFF. Press **[FUNC]** + **DATA ENTRY** knobs to activate the parameters and then turn the **DATA ENTRY** knobs to set a value.



Here you can also name the parameter whose value you control. Press and hold **[FUNC]** and then press and hold any **DATA ENTRY** knob to access the naming screen. For more information, please see “6.5 THE NAMING SCREEN” on page 19.

FLTR PAGE 2

Here you select the first eight CC commands whose values you set with the parameters on the FLTR page 1. Press the corresponding knob or **[YES]** to activate the CC command change.



SEL1-SEL8 (CC 1–8 Select) specifies the CC commands whose values you control controlled by the parameters on the AMP PAGE 1 (CC VALUE) page. The selectable commands are the standard MIDI Control Change Messages.



You can specify the CC command for the SEL parameters by sending the CC value from the external MIDI equipped device you want to control.

1. On FLTR PAGE 2 or AMP PAGE 2 press and hold **[FUNC]** + **DATA ENTRY** knob *A-H*.
2. When the popup screen MIDI LEARN appears, and the parameter starts flashing, you can send a MIDI CC value on the active track's MIDI channel (set in the **SETTINGS > MIDI CONFIG > CHANNELS** menu) or on the auto channel.
3. The popup disappears and the parameter stops flashing when the sent CC value is received and configured on the selected SEL parameter. You can cancel MIDI learn by pressing **[NO]** twice.

AMP PAGE 1

Here you can set the values for eight additional assignable CC commands.

VAL9-VAL16 (CC 9–16 Value) controls the values that the CC commands send. You specify the CC commands themselves on AMP page 2. These parameters default value is OFF. Press **[FUNC]** + **DATA ENTRY** knobs to activate the parameters and then turn the **DATA ENTRY** knobs to set a value.

AMP PAGE 2

Here you select the eight additional CC commands whose values you set with the parameters on AMP page 1. Press the corresponding knob or **[YES]** to activate the parameter change.

SEL9-SEL16 (CC 9–16 Select) specifies the CC commands whose values you control controlled by the parameters on the AMP page 1 (CC VALUE) page. The selectable commands are the standard MIDI Control Change Messages.

A.3 FLTR MACHINES

The FLTR machines are a collection of different filters and EQ.



A.3.1 MULTI-MODE

This filter lets you morph from a Lowpass to Bandpass to Highpass filter



ATK

Attack Time sets the length of the attack phase of the filter envelope.

DEC

Decay Time sets the length of the decay phase of the filter envelope.

SUS

Sustain Level sets the sustain level of the filter envelope.

REL

Release Time sets the length of the release phase of the filter envelope.

FREQ

Frequency sets the cutoff frequency of the multi-mode filter and the center frequency of the EQ.

RESO

Resonance sets the resonance behavior of the filter. Resonance introduces a peak in the spectrum at the cutoff frequency. Gain sets the amount of boost/cut around the center frequency of the EQ.

TYPE

Type morphs the multimode filter from Lowpass to Bandpass to Highpass

ENV

Env. Depth sets the amount of cutoff frequency modulation from the filter envelope. The knob is bipolar, both negative and positive modulation depths are available.

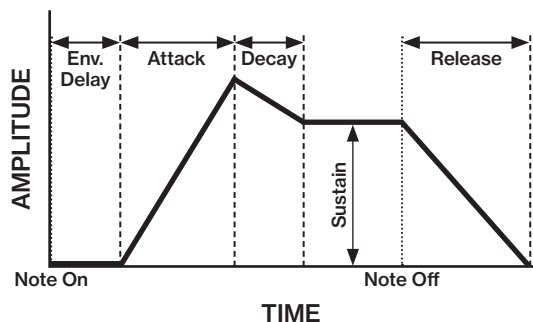

A.3.2 LOWPASS 4

This is a 4-pole low-pass filter with a 24 dB/octave slope.



ATK

Attack Time sets the length of the attack phase of the filter envelope.

DEC

Decay Time sets the length of the decay phase of the filter envelope.

SUS

Sustain Level sets the sustain level of the filter envelope.

REL

Release Time sets the length of the release phase of the filter envelope.

FREQ

Frequency sets the cutoff frequency of the filter.

RESO

Resonance sets the resonance behavior of the filter. Resonance introduces a peak in the spectrum at the cutoff frequency.

ENV

Env. Depth sets the amount of cutoff frequency modulation from the filter envelope. The knob is bipolar, both negative and positive modulation depths are available.

A.3.3 LEGACY LP/HP

The legacy filter is inspired by the filter from Digitone I and is a filter that is switchable between Lowpass and Highpass.



ATK

Attack Time sets the length of the attack phase of the filter envelope.

DEC

Decay Time sets the length of the decay phase of the filter envelope.

SUS

Sustain Level sets the sustain level of the filter envelope.

REL

Release Time sets the length of the release phase of the filter envelope.

FREQ

Frequency sets the cutoff frequency of the filter.

RESO

Resonance sets the resonance of the filter. Resonance introduces a peak at the cutoff frequency.

TYPE

Filter Type lets you select between a Lowpass or Highpass filter, both a 2-pole, 12 dB/octave slope.

ENV

Env. Depth sets the amount of cutoff frequency modulation from the filter envelope. The knob is bipolar, both negative and positive modulation depths are available.

A.3.4 COMB-

The comb filter introduces metallic sounding, pitch tuned, resonant overtones. The comb- filter has negative feedback and produces a more hollow, tube-like sound.

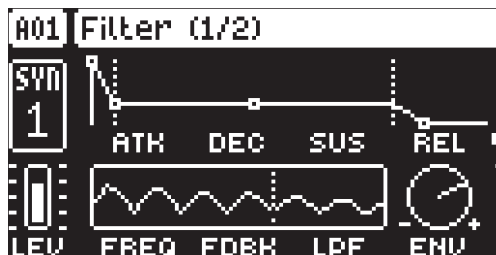

ATK

Attack Time sets the length of the attack phase of the filter envelope.

DEC

Decay Time sets the length of the decay phase of the filter envelope.

SUS

Sustain Level sets the sustain level of the filter envelope.

REL

Release Time sets the length of the release phase of the filter envelope.

FREQ

Frequency sets the resonant frequencies of the comb filter.

FDBK

Feedback sets the gain of the feedback signal. Please beware that setting **FDBK** to a high value can create a very loud sound.

LPF

Low Pass Filter sets the cutoff frequency of the low pass filter in the feedback signal.

ENV

Env. Depth sets the amount of cutoff frequency modulation from the filter envelope. The knob is bipolar, both negative and positive modulation depths are available.

A.3.5 COMB+

The comb filter introduces metallic sounding, pitch tuned, resonant overtones. The comb+ filter has positive feedback and produces a more string-like sound.

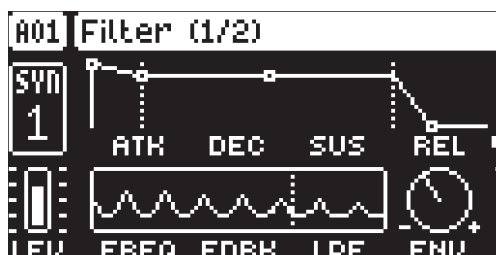

ATK

Attack Time sets the length of the attack phase of the filter envelope.

DEC

Decay Time sets the length of the decay phase of the filter envelope.

SUS

Sustain Level sets the sustain level of the filter envelope.

REL

Release Time sets the length of the release phase of the filter envelope.

FREQ

Frequency sets the resonant frequencies of the comb filter.

FDBK

Feedback sets the gain of the feedback signal. Please beware that setting **FDBK** to a high value can create a very loud sound.

LPF

Low Pass Filter sets the cutoff frequency of the low pass filter in the feedback signal.

ENV

Env. Depth sets the amount of cutoff frequency modulation from the filter envelope. The knob is bipolar, both negative and positive modulation depths are available.

A.3.6 EQUALIZER

This machine is a parametric Equalizer.

**ATK**

Attack Time sets the length of the attack phase of the EQ envelope.

DEC

Decay Time sets the length of the decay phase of the EQ envelope.

SUS

Sustain Level sets the sustain level of the EQ envelope.

REL

Release Time sets the length of the release phase of the EQ envelope.

FREQ

Frequency sets the center frequency of the EQ.

GAIN

Gain sets the amount of boost/cut around the center frequency of the EQ.

Q

Q lets you select the bandwidth of the frequency range that the EQ affects. The higher the Q value, the narrower the bandwidth. A broad bandwidth boosts or cuts a larger band of frequencies than a narrow.

ENV

Env. Depth sets the amount of cutoff frequency modulation from the filter envelope. The knob is bipolar, both negative and positive modulation depths are available.



The parametric EQ is used to boost desired frequencies or to remove unwanted frequencies of the sound.



The ATK, DEC, SUS, and REL parameters only affects the selected filter machine. Not the base-width filter on FLTR page 2.

APPENDIX B: THE FM TONE SYNTHESIS

B.1 OVERVIEW

The Digitone II's FM TONE machine is a four operator Frequency Modulation (FM) synth in the style of the classic 80s implementations. However, unlike the early FM synths, the Digitone II use its FM engine more like a complex tone generator than a complete synthesizer voice (although it does have this capability too). The Digitone II signal path is more similar to a typical subtractive synth than a classic FM voice.

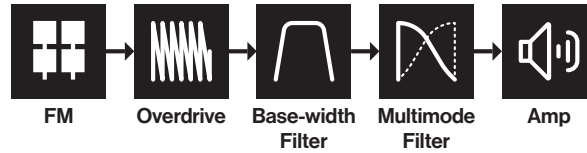

The idea of this design is to harness the raw, and often complex, soundscapes of FM synthesis and use a more well-known and approachable subtractive method for the overall sound shaping.

FM is a synthesis method where you add harmonics to the timbre by using modulation or layering to shape the sound. You add harmonics by modulating one oscillator's pitch with the output of another oscillator. FM works similarly to how you would apply vibrato via an LFO. At slower modulation rates, it is simply vibrato, but when the modulating frequency reaches audio rate, the vibrato effects becomes a part of the sound and becomes a timbral effect instead.

B.2 OPERATORS

In FM synthesis the oscillators are called operators. Unlike the analog oscillator, the operator also contains an envelope and specific input and outputs, making it a sort of macro oscillator. FM combines two or more operators to generate a more harmonically rich output. An operator that is used to modulate another operator is called a modulator. The operator that generates, or carries, the resulting tone is called a carrier.

Feedback is used to increase the sharpness of a sound and is usually only applied to modulators. The output of the operator is fed back into itself, resulting in added harmonics. For example, have a look at the Sounds B001 and B002 in the Digitone II to see how feedback is used to create a basic square and saw waveform. For more information, please see "A.2.1 FM TONE" on page 87.

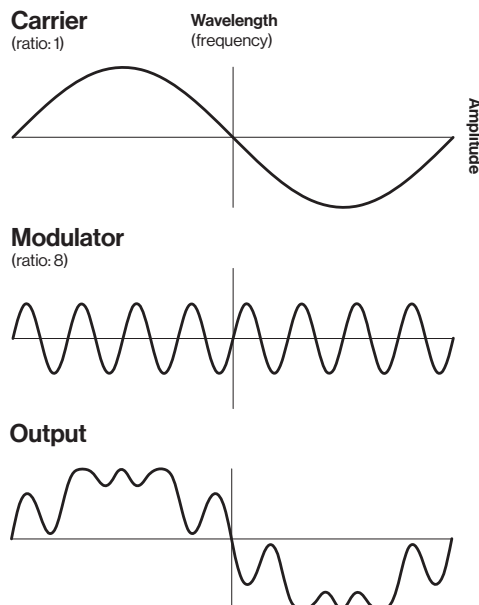
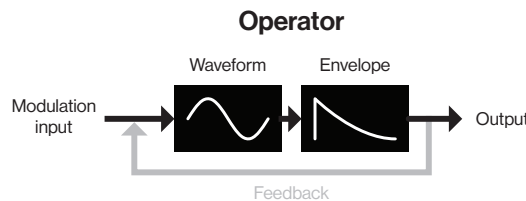

In some instances, an operator can be both carrier and modulator. This means that it outputs its result as a tone while also using it to modulate another operator. We have divided the operators into three groups: **C**, **A**, and **B** (B1 and B2) to lessen the complexity and make the Digitone II easier to use. Since group **B** consist of two operators, the parameter controls for **B** are macro mapped to both operators.

B.3 ALGORITHMS

An algorithm is a set routing, or combination, of the operators. Routing the modulation in different ways gives you several different methods of applying modulation and naturally different results.

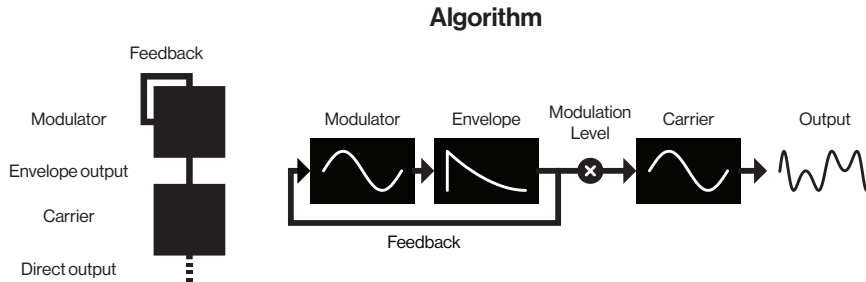

Pictured above is a 2 operator algorithm, which is FM synthesis in its most basic form. The Digitone II has four operators available which can be routed in many different ways. Different algorithms dramatically changes the characteristics of the output - for example stacking four operators can lead to very complex timbres.

The Digitone II has eight different algorithms where the four operators are routed in different ways. For more information, please see “A.2.1 FM TONE” on page 87. Each algorithm has two carrier outputs (X and Y) that come from two different operators depending on what algorithm you chose. It is possible to use the **MIX** parameter to mix between these outputs so that you can cross-fade between two separate timbres. For more information, please see “A.2.1 FM TONE” on page 87.

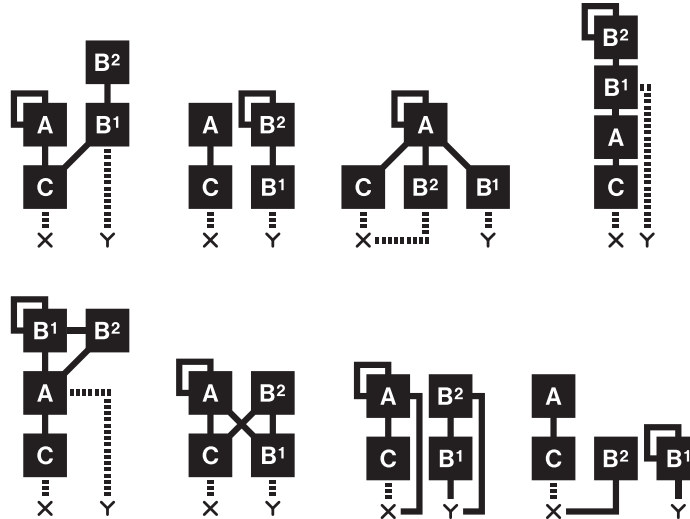

The lines going to X and Y indicate the output from a carrier. There are two different ways a carrier output is sent to the X/Y outputs: 1. Its amplitude is unaffected by the operator envelope (dotted line). 2. Its amplitude is affected by the operator envelope (filled line). The sound from the X/Y outputs is then routed via the overdrive to the filters.

B.4 FM RATIOS

Frequency modulation is applied in multipliers of the principal frequency to retain the sounds tonality. These multipliers are known as ratios. Each operator group's ratio is a multiplier of the input pitch (note value). The higher the ratio, the higher the pitch frequency. For example, when applying modulation with a ratio of 1:2 (carrier:modulator), the carrier output resembles a square wave. A ratio of 1:1 sounds like a sawtooth, and odd numbers can be used for various metallic or other “natural” sounds. In Digitone II, the FM ratios for the different operator groups works like this:

C which always works like a carrier, is limited mostly to integers since it is generally used for carrying the base note of the sound. For more information, please see "A.2.1 FM TONE" on page 87.

A has a more extensive number of ratio values to allow for more inharmonic relationships. For more information, please see "A.2.1 FM TONE" on page 87.

B (B1 and B2) controls both operators at the same time. The minimum value for B1 and B2 is .25. As you turn the encoder, B2 increases until it reaches the max (16). It then starts over from .25 and B1 increases to the next value (0.5). This revolving behavior continues until both operators reach the maximum value. This parameter behavior is similar to the movement of the hands on a watch. For more information, please see "A.2.1 FM TONE" on page 87.

B.5 OPERATOR ENVELOPES

If you modulate one oscillator directly with another it creates very harsh harmonics, so you need to limit the modulation level to control the amount of modulation. In Digitone II you use an envelope and a LEVEL parameter control to attenuate the amount of how much the modulator affects the carrier. The envelopes also give the possibility to control the modulation over time. A piano for example, when first struck, the timbre is sharp but quickly fades to a softer tone. Envelopes and modulation level are vital elements in FM synthesis and are the tools that you use to shape the sounds you want to achieve.

The Digitone II FM engine has two operator envelopes that are designed to be practical and easy to use. One envelope is for operator group A, and one is for group B (B1 and B2).

The envelopes are essentially expanded AD (Attack Decay) envelopes, but with an added adjustable end level (the amplitude level the sound reaches at the end of the decay stage). Normally, an AD envelope always ends at zero level, but with FM you often want to retain some modulation after a short pluck or fade in for example. For more information, please see "A.2.1 FM TONE" on page 87.



Please note that operator envelope B controls the output from both B1 and B2.

The envelopes can be either triggered or gated - making it either an ADE (Attack Decay End) or an ASDE (Attack Sustain Decay End) envelope. The sustain phase does not have an envelope level. It is instead the LEV parameter that sets the sustain level. The note length defines the length of the sustain phase. For more information, please see "A.2.1 FM TONE" on page 87.

Triggered (ATRГ/BTRГ ON)

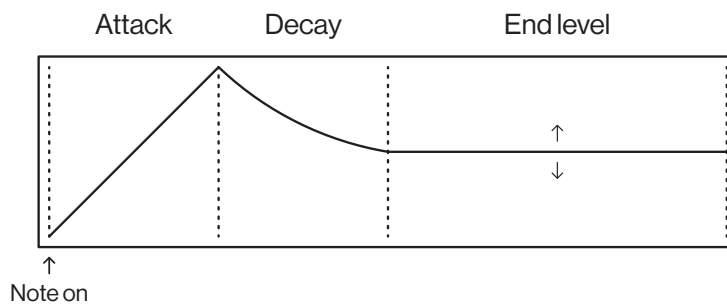

Gated (ATRГ/BTRГ OFF)

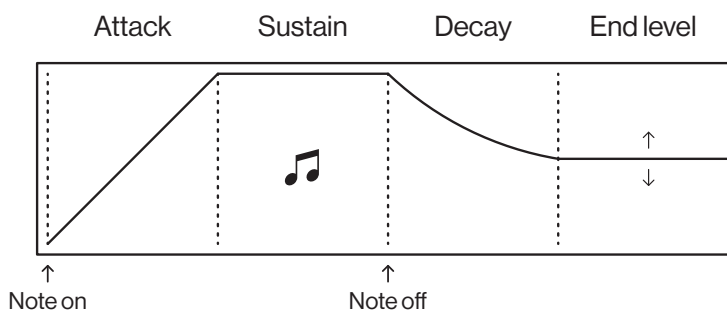

You can also set if the envelopes should reset or not when they are retriggered. For more information, please see "A.2.1 FM TONE" on page 87.

Reset on (ARST/BRST ON)

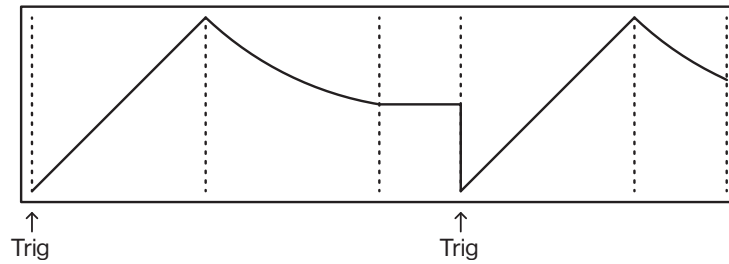

Reset off (ARST/BRST OFF)

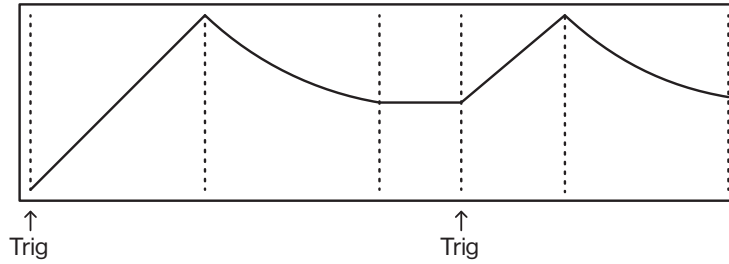

The **LEVEL** parameters on the SYN2 page controls the amount of modulation from the A and B operators. For more information, please see “A.2.1 FM TONE” on page 87. The **LEVEL** parameter for B is macro mapped to both operator B1 and B2 and control their modulation amount as per this graph:

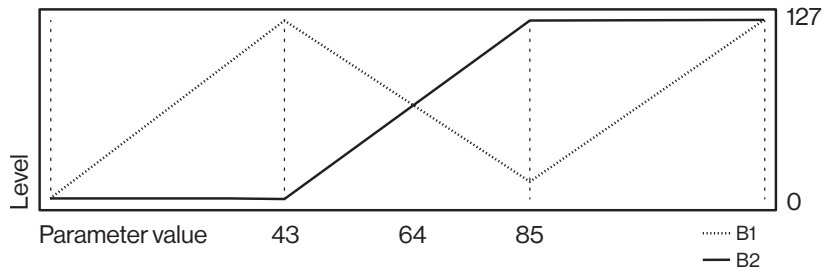

B.6 HARMONICS

The default output from an operator is a sine wave, but you can use the **HARM** parameter to add upper partials to some of the operators' sine waves to create more harmonically rich waveforms. The **HARM** parameter is bipolar. Negative parameter values change the harmonics of operator C, while positive parameter values change the harmonics of operators A and B1.

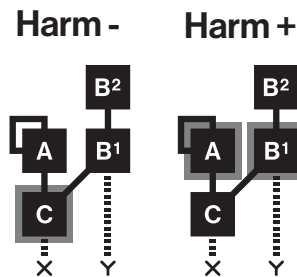

When changing harmonics, intermediate values interpolates between the current and the next harmonic. This interpolation works much like in wavetable synthesis, sweeping between the harmonics, smoothly transitioning from one timbre to another. For more information, please see “A.2.1 FM TONE” on page 87. The harmonic series for the operators looks like this:

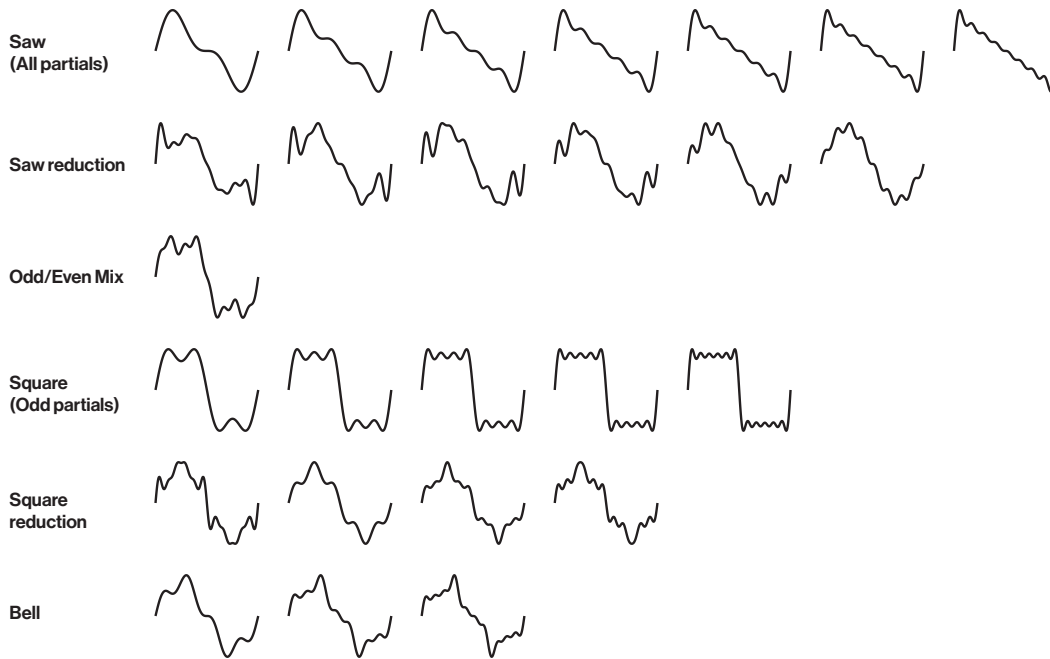

The Digitone II uses a form of additive synthesis to create the harmonic series for the **HARM** parameter. Additive synthesis is one of the oldest forms of electronic sound generation. It is a quite simple form of synthesis but still very powerful. The basic principle is to add multiple sine waves together to form complex timbres. Each sine wave is called a partial. By attenuating each partial, the timbre changes its harmonic content, resulting in different waveforms.

The first partial is always kept at full volume, which keeps the base octave intact.



Adding every partial in series will replicate a sawtooth. Note how the volume decreases for each partial, creating a natural falloff.

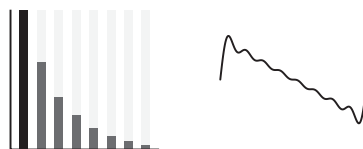

Adding every odd partial in series will approximate a square wave.



The additive method can be used to make many different timbres. This combination of partials, for example, sounds close to a bell tone.



B.7 SYN PAGE 1 PARAMETERS OVERVIEW

Here is a graphical overview of what part of the FM engine the parameters on the SYN1 pages affects. The affected part of the FM engine is highlighted with grey. For more information, please see "A.2.1 FM TONE" on page 87.

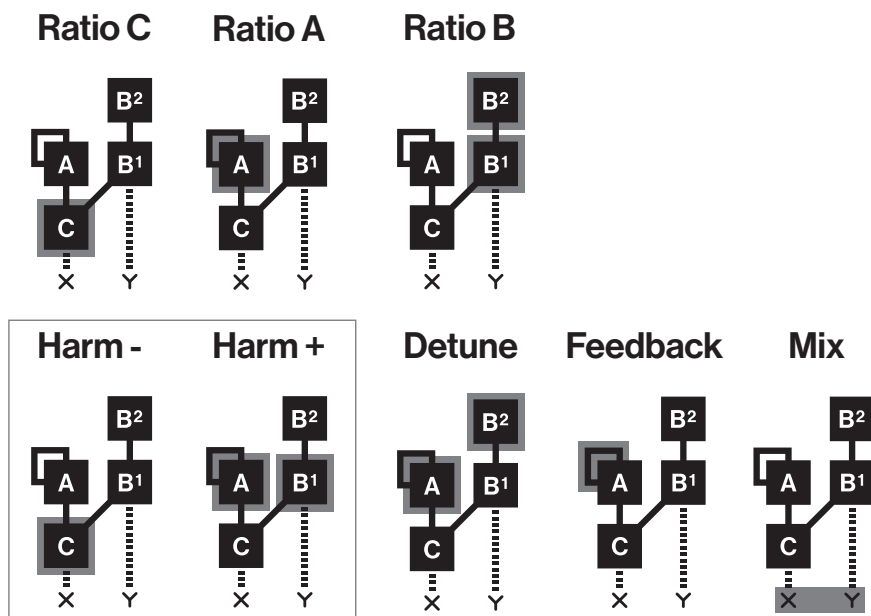

APPENDIX C: MIDI

This appendix lists the CC and NRPN specification for the Digitone II.

C.1 TRACK PARAMETERS

TRACK				
Parameter	CC MSB	CC LSB	NRPN MSB	NRPN LSB
Mute	94		1	108
Track level	95		1	110

C.2 TRIG PARAMETERS

TRIG PARAMETERS				
Parameter	CC MSB	CC LSB	NRPN MSB	NRPN LSB
Note	3		3	0
Velocity	4		3	1
Length	5		3	2
Filter Trig	13			
LFO Trig	14			
Portamento Time	9		3	6
Portamento On/Off	65		3	7

C.3 SOURCE PARAMETERS

SYN PAGE 1				
Parameter	CC MSB	CC LSB	NRPN MSB	NRPN LSB
Data entry knob A (machine dependent)	40		1	73
Data entry knob B (machine dependent)	41		1	74
Data entry knob C (machine dependent)	42		1	75
Data entry knob D (machine dependent)	43		1	76
Data entry knob E (machine dependent)	44		1	77
Data entry knob F (machine dependent)	45		1	78
Data entry knob G (machine dependent)	46		1	79
Data entry knob H (machine dependent)	47		1	80

SYN PAGE 2				
Parameter	CC MSB	CC LSB	NRPN MSB	NRPN LSB
Data entry knob A (machine dependent)	48		1	81
Data entry knob B (machine dependent)	49		1	82
Data entry knob C (machine dependent)	50		1	83
Data entry knob D (machine dependent)	51		1	84
Data entry knob E (machine dependent)	52		1	85
Data entry knob F (machine dependent)	53		1	86
Data entry knob G (machine dependent)	54		1	87
Data entry knob H (machine dependent)	55		1	88

SYN PAGE 3				
Parameter	CC MSB	CC LSB	NRPN MSB	NRPN LSB
Data entry knob A (machine dependent)	56		1	89
Data entry knob B (machine dependent)	57		1	90
Data entry knob C (machine dependent)	58		1	91

SYN PAGE 3				
Parameter	CC MSB	CC LSB	NRPN MSB	NRPN LSB
Data entry knob D (machine dependent)	59		1	92
Data entry knob E (machine dependent)	60		1	93
Data entry knob F (machine dependent)	61		1	94
Data entry knob G (machine dependent)	62		1	95
Data entry knob H (machine dependent)	63		1	96

SYN PAGE 4				
Parameter	CC MSB	CC LSB	NRPN MSB	NRPN LSB
Data entry knob A (machine dependent)	70		1	97
Data entry knob B (machine dependent)	71		1	98
Data entry knob C (machine dependent)	72		1	99
Data entry knob D (machine dependent)	73		1	100
Data entry knob E (machine dependent)	74		1	101
Data entry knob F (machine dependent)	75		1	102
Data entry knob G (machine dependent)	76		1	103
Data entry knob H (machine dependent)	77		1	104

C.4 FILTER PARAMETERS

FILTER				
Parameter	CC MSB	CC LSB	NRPN MSB	NRPN LSB
Frequency	16		1	20
Data entry knob F (machine dependent)	17		1	21
Data entry knob G (machine dependent)	18		1	22
Env. Depth	24		1	26
Attack Time	20		1	16
Decay Time	21		1	17
Sustain Level	22		1	18
Release Time	23		1	19
Env. Delay	19		1	23
Key Tracking	26		1	69
Base	27		1	24
Width	28		1	25
Env. Reset	25		1	68

C.5 AMP PARAMETERS

AMP				
Parameter	CC MSB	CC LSB	NRPN MSB	NRPN LSB
Attack Time	84		1	30
Hold Time	85		1	31
Decay Time	86		1	32
Sustain Level	86		1	33
Release Time	88		1	34
Env. Reset	92		1	41
Mode	91		1	40
Pan	89		1	38
Volume	90		1	39

C.6 EUCLIDEAN SEQUENCER PARAMETERS

AMP				
Parameter	CC MSB	CC LSB	NRPN MSB	NRPN LSB
Pulse Generator 1			3	8
Pulse Generator 2			3	9
Euclidean Mode On/Off			3	14
Rotation Generator 1			3	11
Rotation Generator 2			3	12
Track Rotation			3	13
Boolean Operator			3	10

C.7 FX PARAMETERS

AMP				
Parameter	CC MSB	CC LSB	NRPN MSB	NRPN LSB
Bit Reduction	78		1	5
Overdrive	81		1	8
Sample Rate Reduction	79		1	6
SRR Routing	80		1	7
Overdrive Routing	82		1	9
Delay Send	30		1	36
Reverb Send	31		1	37
Chorus Send	29		1	35

C.8 MOD PARAMETERS.

LFO 1				
Parameter	CC MSB	CC LSB	NRPN MSB	NRPN LSB
Speed	102		1	42
Multiplier	103		1	43
Fade In/Out	104		1	44
Destination	105		1	45
Waveform	106		1	46
Start Phase/Slew	107		1	47
Trig Mode	108		1	48
Depth	109		1	49

LFO 2				
Parameter	CC MSB	CC LSB	NRPN MSB	NRPN LSB
Speed	111		1	50
Multiplier	112		1	51
Fade In/Out	113		1	52
Destination	114		1	53
Waveform	115		1	54
Start Phase/Slew	116		1	55
Trig Mode	117		1	56
Depth	118		1	57

LFO 3				
Parameter	CC MSB	CC LSB	NRPN MSB	NRPN LSB
Speed			1	58
Multiplier			1	59
Fade In/Out			1	60
Destination			1	61
Waveform			1	62
Start Phase/Slew			1	70
Trig Mode			1	71
Depth			1	72

C.9 SEND FX PARAMETERS

DELAY				
Parameter	CC MSB	CC LSB	NRPN MSB	NRPN LSB
Delay Time	21		2	0
Pingpong	22		2	1
Stereo Width	23		2	2
Feedback	24		2	3
Highpass Filter	25		2	4
Lowpass Filter	26		2	5
Reverb Send	27		2	6
Mix Volume	28		2	7

REVERB				
Parameter	CC MSB	CC LSB	NRPN MSB	NRPN LSB
Predelay	29		2	8
Decay Time	30		2	9
Shelving Freq	31		2	10
Shelving Gain	89		2	11
Highpass Filter	90		2	12
Lowpass Filter	91		2	13
Mix Volume	92		2	15

CHORUS				
Parameter	CC MSB	CC LSB	NRPN MSB	NRPN LSB
Depth	16		2	41
Speed	9		2	42
High Pass Filter	70		2	43
Width	71		2	44
Delay Send	12		2	45
Reverb Send	13		2	46
Mix Volume	14		2	47

C.10 MIXER PARAMETERS

COMPRESSOR				
Parameter	CC MSB	CC LSB	NRPN MSB	NRPN LSB
Threshold	111		2	16
Attack Time	112		2	17
Release Time	113		2	18
Makeup Gain	114		2	19
Pattern Volume	119		2	24
Ratio	115		2	20
Sidechain Source	116		2	21
Sidechain Filter	117		2	22
Dry/Wet Mix	118		2	23

EXTERNAL IN MIXER				
Parameter	CC MSB	CC LSB	NRPN MSB	NRPN LSB
Dual Mono	82		2	40
Input L Level	72		2	30
Input L Pan	74		2	32
Input R Level	73		2	31
Input R Pan	75		2	33
Input L Delay Send	78		2	36
Input R Delay Send	79		2	37
Input L Reverb Send	80		2	38
Input R Reverb Send	81		2	39
Input L Chorus Send	76		2	34
Input R Chorus Send	77		2	35
Input L R Level	72		2	30
Input L R Balance	74		2	32
Input L R Delay Send	78		2	36
Input L R Reverb Send	80		2	38
Input L R Chorus Send	76		2	34

C.11 VAL PARAMETERS

These are the CC VAL parameters on the [FLTR] and [AMP] pages for MIDI tracks.

CC VAL				
Parameter	CC MSB	CC LSB	NRPN MSB	NRPN LSB
VAL1	70		1	16
VAL2	71		1	17
VAL3	72		1	18
VAL4	73		1	19
VAL5	74		1	20
VAL6	75		1	21
VAL7	76		1	22
VAL8	77		1	23
VAL9	78		1	60
VAL10	79		1	61

CC VAL				
Parameter	CC MSB	CC LSB	NRPN MSB	NRPN LSB
VAL11	80		1	62
VAL12	81		1	63
VAL13	82		1	64
VAL14	83		1	65
VAL15	84		1	66
VAL16	85		1	67

C.12 MISC PARAMETERS

MISC				
Parameter	CC MSB	CC LSB	NRPN MSB	NRPN LSB
Pattern Mute	110		1	109
Master Overdrive	17		2	50

APPENDIX D: LFO MODULATION DESTINATIONS

The following are the modulation destinations for the Digitone II's LFOs:

AUDIO TRACKS

META: None

LFO1: Speed (Only available for LFO2/3)

LFO1: Multiplier (Only available for LFO2/3)

LFO1: Fade In/Out (Only available for LFO2/3)

LFO1: Waveform (Only available for LFO2/3)

LFO1: Start Phase (Only available for LFO2/3)

LFO1: Trig Mode (Only available for LFO2/3)

LFO1: Depth (Only available for LFO2/3)

LFO2: Speed (Only available for LFO3)

LFO2: Multiplier (Only available for LFO3)

LFO2: Fade In/Out (Only available for LFO3)

LFO2: Waveform (Only available for LFO3)

LFO2: Start Phase (Only available for LFO3)

LFO2: Trig Mode (Only available for LFO3)

LFO2: Depth (Only available for LFO3)

SYN: Data entry knob A, page 1–4
(machine dependent.)

SYN: Data entry knob B, page 1–4
(machine dependent)

SYN: Data entry knob C, page 1–4
(machine dependent)

SYN: Data entry knob D, page 1–4
(machine dependent)

SYN: Data entry knob E, page 1–4
(machine dependent)

SYN: Data entry knob F, page 1–4
(machine dependent)

SYN: Data entry knob G, page 1–4
(machine dependent)

SYN: Data entry knob H, page 1–4
(machine dependent)

FILTER: Attack Time

FILTER: Decay Time

FILTER: Sustain Level

FILTER: Release Time

FILTER: Frequency

FILTER: Data entry knob F (machine dependent)

FILTER: Data entry knob G (machine dependent)

FILTER: Envelope Depth

FILTER: Env. Delay

FILTER: Key Tracking

FILTER: Base

FILTER: Width

FILTER: Env. Reset

AMP: Attack Time

AMP: Hold Time

AMP: Decay Time

AMP: Sustain Level

AMP: Release Time

AMP: Pan

AMP: Volume

FX: Delay Send

FX: Reverb Send

FX: Chorus Send

FX: Bit Reduction

FX: SRR

FX: SRR Routing

FX: Overdrive

MIDI TRACKS

META: None

LFO1: Speed (Only available for LFO2)

LFO1: Multiplier (Only available for LFO2)

LFO1: Fade In/Out (Only available for LFO2)

LFO1: Waveform (Only available for LFO2)

LFO1: Start Phase (Only available for LFO2)

LFO1: Trig Mode (Only available for LFO2)

LFO1: Depth (Only available for LFO2)

SYN: Pitch Bend

SYN: Aftertouch

SYN: Mod Wheel

SYN: Breath Controller

CC: CC1–16 Values

APPENDIX E: KEYBOARD SCALES

The following are the selectable scales for the KEYBOARD mode. For more information, please see: "8.5.1 KEYBOARD MODE" on page 24,

- CHROMATIC
- IONIAN (MAJOR)
- DORIAN
- PHRYGIAN
- LYDIAN
- MIXOLYDIAN
- AEOLIAN (MINOR)
- LOCRIAN
- PENTATONIC MINOR
- PENTATONIC MAJOR
- MELODIC MINOR
- HARMONIC MINOR
- WHOLE TONE
- BLUES
- COMBO MINOR
- PERSIAN
- IWATO
- IN-SEN
- HIRAJOSHI
- PELOG
- PHRYGIAN DOMINANT
- WHOLE-HALF DIMINISHED
- HALF-WHOLE DIMINISHED
- SPANISH
- MAJOR LOCRIAN
- SUPER LOCRIAN
- DORIAN *b*2
- LYDIAN AUGMENTED
- LYDIAN DOMINANT
- DOUBLE HARMONIC MAJOR
- LYDIAN #2 #6
- ULTRAPHRYGIAN
- HUNGARIAN MINOR
- ORIENTAL
- IONIAN #2 #5
- LOCRIAN *bb*3 *bb*7

INDEX

+DRIVE 16, 28

A

ARPEGGIATOR 38

AUDIO ROUTING

Global 75

B

BACKUP 20

BREATH CONTROLLER 38

C

CHAINS 39

CHORUS 65

CHROMATIC MODE 24

CLASS COMPLIANT 20

COMPRESSOR 65

CONDITIONAL LOCKS 49

CONNECTORS 14

CONTROL ALL 19

Configuration 34

COPY, PASTE AND CLEAR 50

CREDITS AND CONTACT INFORMATION 86

D

DATA STRUCTURE 16

Patterns 16

Presets 16

Project 16

DELAY 63

E

EARLY STARTUP MENU 79

EUCLIDEAN SEQUENCER 44

F

FACTORY RESET 79

FILL MODE 50

FILTER 57

FLTR MACHINES 100

FM SYNTHESIS

Algorithms 106

Carrier 105

FM ratios 106

Harmonics 108

Modulator 105

Operator envelopes 107

Operators 105

SYN1 Page 1 parameters overview 110

FX AND MIXER PARAMETERS 63

Chorus 65

Compressor 65

Delay 63

External mixer 68

FX mixer 68

Internal mixer 67

Reverb 64

G

GRID RECORDING MODE 41

H

HARD SYNC 95

K

KEYBOARD SCALE 25

KEYBOARD SCALES 118

KEY COMBINATIONS 82

KITS 28

L

LED BACKLIGHT 76

LED INTENSITY 76

LFO 61, 62

Modulation destinations 117

M

MACHINES 16, 87

Assigning to track 87

METRONOME 23

MICRO TIMING 46

MIDI CC & NRPN 111

MIDI CONFIG 72

MIDI LEARN 99

MIDI TRACKS 17

Parameters 97

MIXER 67, 68

MUTE MODE 25

N

NAMING SCREEN 19

NOTE EDIT 41

NOTE EDIT MENU 41

O

OS UPGRADE 78

P

PAGE SETUP

Length per pattern mode 46

Length per track mode 47

PANEL LAYOUT 12

PARAMETER LOCKS 48

PATTERNS

Grid recording mode 41

Live recording mode 42

Parameter locks 48

Pattern control 39

Selecting a pattern 39

Trig modes 26

Trig Types 40
PATTERNS, KITS AND PRESETS 28
Editing a preset 33
Playing a preset 33
PERFORM KIT MODE 53
PORTAMENTO 36
On/Off 57
PRESET LOCKS 48
PRESETS 28
Audio track parameters 55
Editing a preset 33
Playing a preset 33
Saving a preset 34
PRESET SELECTING 22
PROJECT MANAGER 70
PROJECTS 70
Load 70
Project Manager 70
Save 70
Write protection 70
PURGE (REMOVE UNUSED)
All 70
Kits 33

Q

QUANTIZATION 46
QUICK SCROLLING 19
QUICK START 22

R

RETRIGS 46, 56
REVERB 64
RING MODULATION 95

S

SAFETY AND MAINTENANCE 3
SCALES 118
SCREEN SAVER 18
SEQUENCER 39
Conditional locks 49
Editing a pattern 40
Parameter locks 48
Pattern control 39
Retrig Menu 46
Scale Menu 46
Selecting a pattern 39
Trig menu 44
Trig parameters page 46
SEQUENCER RECORDING MODES
Grid recording mode 41
Live recording mode 42
SETTINGS 70
MIDI config 71, 72
Project 70
System 76, 77
SETUP EXAMPLES 80

Controlling a synthesizer using the MIDI tracks 80
Digitone II with a monophonic bass machine 80

SONG MODE 51
SOUND ARCHITECTURE 15
SWING 23
SYN MACHINES 87
SYSEX DUMP 74

T

TECHNICAL INFORMATION 85
TEMPO 23
TEMPORARY SAVE AND RELOAD 50
TRACK PARAMETERS 55
Amp 57
Filter 57
LFO 60
Syn 57
Trig 55, 56

TRANPOSE

Pattern transpose 51
Track transpose 51

TRIG MODE 26

TRIGS 40
Lock trigs 40
Note trigs 40
Parameter locks 48

U

UNISON 45

V

VOICE MENU 45
Locked voices 45
Unison 45
Voice stealing 42, 45

